

D

Schaltplan

GB

Circuit diagram

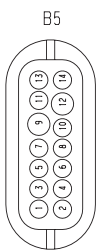
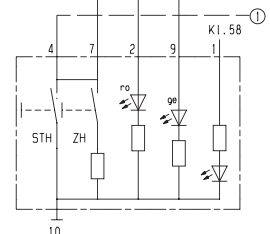
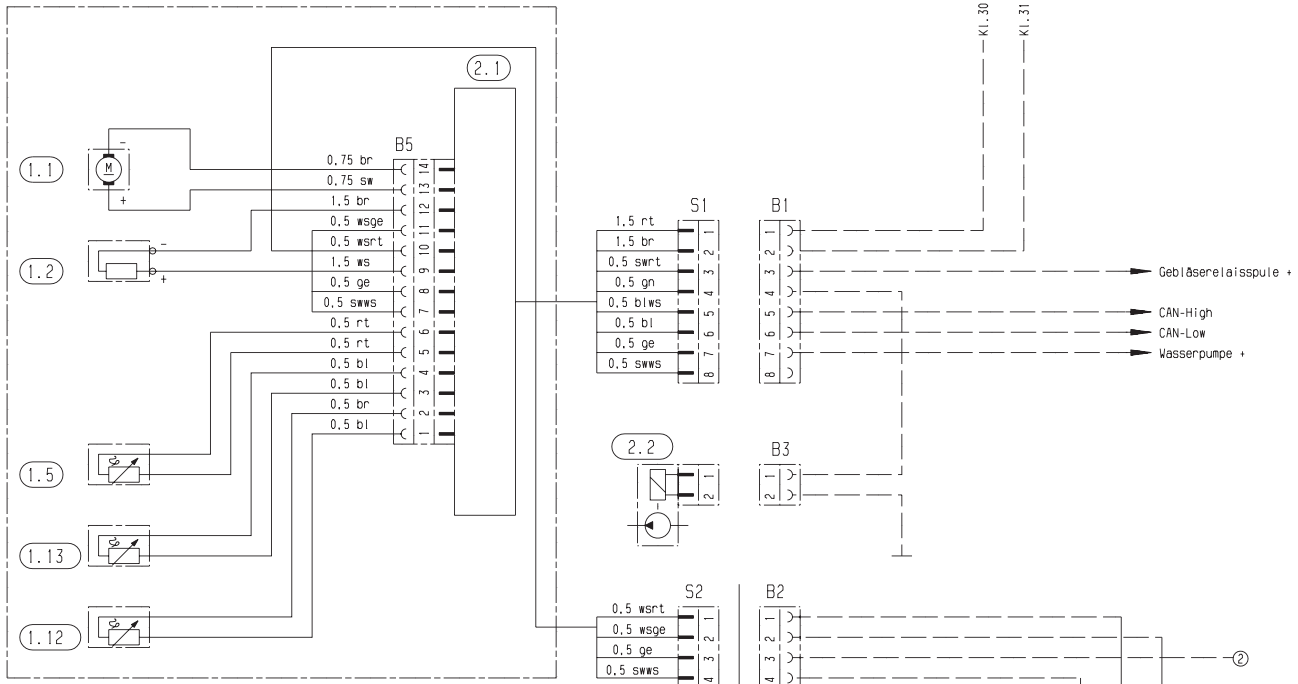

Flachkontaktgehäuse
8-pol., Dautz & Rietz
3A0 973 734 - VW

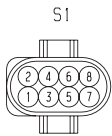

Flachsteckergehäuse
8-pol., Dautz & Rietz
3A0 973 834 - VW

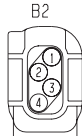
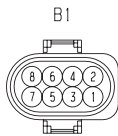

Buchsengehäuse
AMP-967670
DC A210 540 42 81



Stiftgehäuse
4-pol., AMP 1-967584-1
DC A210 540 48 81



Steckhülisengehäuse 2-pol.,
0-282 189-1 AMP

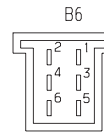

Gegenstecker
929 504-2 AMP



Junior-Timer
Gehäuse
929 504 - 2 AMP

Steckhülisengehäuse
967 525 - 1 AMP
14 - pol.



Ⓓ

Teilleiste

- 1.1 Brennermotor
- 1.2 Glühstift
- 1.5.4 Überhitzungsfühler
- 1.12 Flammfühler
- 1.13 Temperaturfühler

- 2.1 Steuergerät
- 2.2 Dosierpumpe

3.2.6 Funkfernbedienung TP 43i

Stecker- und Buchsengehäuse sind von der Leitungseintrittsseite dargestellt.

Ⓔ

Parts list

- 1.1 Burner motor
- 1.2 Glow plug
- 1.5.4 Overheating sensor
- 1.12 Flame sensor
- 1.17 Temperatur sensor

- 2.1 Control box
- 2.2 Metering pump

3.2.6 Radio remote control TP 43i

Connector and bush housings are shown from the lead inlet side.

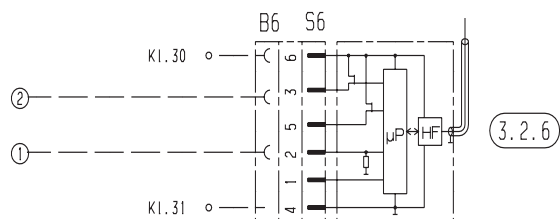

25 2196 00 96 01

Kabelfarben

- bl = blau
- br = braun
- ge = gelb
- gn = grün
- gr = grau
- li = lila
- or = orange
- rs = rosa
- rt = rot
- sw = schwarz
- vi = violett
- ws = weiß

Cable colours

- bl = blue
- br = brown
- ge = yellow
- gn = green
- gr = grey
- li = purple
- or = orange
- rs = pink
- rt = red
- sw = black
- vi = violet
- ws = white