

# Water Heater



**Thermo Top E Parking Heater**

  
00 0003

**Thermo Top C Parking Heater**

  
00 0002

**Thermo Top P Parking Heater**

  
00 0104

## Installation instructions

### Citroen C4

Gasoline and Diesel  
from Model Year 2004  
Left-hand drive vehicle



#### **WARNING!**

Hazard warning:

Incorrect installation or repair of Webasto heating systems may cause a fire or result in the emission of carbon monoxide, which can be fatal. Serious or fatal injuries can be caused as a result.



Specialist company training, technical documentation, specialised tools and equipment are required to install and repair Webasto heating and cooling systems. Only original Webasto parts must be used. For this, also see the catalog of air and water heater accessories from Webasto.

**NEVER attempt to install or repair Webasto heating or cooling systems if you have not successfully completed the company training and thereby acquired the required technical skills, or if you do not have access to the required technical documentation, tools and equipment needed to carry out correct installation and repairs.**

ALWAYS follow all Webasto installation and repair instructions and observe all warnings.

Webasto does not accept any liability for defects and damage that are attributable to installation by untrained staff.

## Table of Contents

Heater/Installation Kit	3	Preparing heater	13
Foreword	3	Preparing installation location	14
General Instructions	3	Installing bracket	15
Special Tools	3	Installing heater	16
Explanatory Notes on Document	4	Coolant circuit	17
Preliminary Work	5	Fuel	24
Heater installation location	5	Combustion air	29
Preparing electrical system	6	Exhaust gas	30
Electrical system	7	Final Work	32
Fan controller for manual air conditioning	8	Gasoline fuel standpipe	33
Automatic air-conditioning fan controller	9	Diesel fuel standpipe	34
Digital timer, summer/winter switch option	11	Operating Instructions for End Customer	35
Remote option (Telestart)	11		
Remote option Thermo Call	12		

## Validity

Manufacturer	Model	Type	EG-BE No./ABE
Citroen	C4	L	e2 * 2001/116 * 0360 *...

Engine type	Engine model	Output in kW	Displacement in cm <sup>3</sup>
KFU	Gasoline	65	1360
NFU	Gasoline	80	1587
5FW	Gasoline	88	1598
RFN	Gasoline	100	1997
9HX	Diesel	66	1560
9HZ	Diesel	80	1560
9HY	Diesel	80	1560
RHR	Diesel	100	1997

Vehicle and engine types, equipment variants and national specifications not listed in these installation instructions have not been tested. However, installation according to these installation instructions may be possible.

The installation location of a digital timer and summer/winter switch should be confirmed with the end customer before installation.

## Heater/Installation Kit

Quantity	Description	Order No.:
1	Retail accessories <i>Thermo Top E / C / P</i>	See price list
1	Heater control	See price list
1	Installation kit for Citroen C4 Gasoline and Diesel Manual air conditioning	1303584B
or		
1	Installation kit for Citroen C4 Gasoline and Diesel Automatic air-conditioning	1303568C

### Heater recommended for the respective vehicle class:

Vehicle	Heater
Compact car	Thermo Top E
Mid-size car, station wagon	Thermo Top C
Full-size car, van, offroader	Thermo Top P

The selection of the heater is based on the passenger compartment size of the vehicle and the level of comfort required by the customer!



## Foreword

These installation instructions apply to the vehicles Citroen C4 Gasoline and Diesel - for validity, see page 2 - from model year 2004 and later, assuming technical modifications to the vehicle do not affect installation, any liability claims excluded. Depending on the vehicle version and equipment, modifications may be necessary during installation with respect to these installation instructions.

However, the stipulations in these "installation instructions" and "operating and maintenance instructions" for the *Thermo Top C/P/E* must always be observed. The corresponding rules of technology and any information from the vehicle manufacturer should be observed during the installation work.

## General Instructions

Installation should be carried out according to the general, standard rules of technology. Unless specified otherwise, fasten hoses, lines and wiring harnesses to original vehicle lines and wiring harnesses using cable ties.

Sharp edges must be provided with rub protection (cut-open fuel hose)!

Spray unfinished body areas, e.g. drilled holes, with anti-corrosion wax (Tectyl 100K, Order No. 111329).

## Special Tools

- Torque wrench for 2.0 - 10 Nm
- Hose clamping pliers
- Metric thread-setter kit

**Explanatory Notes on Document**

To provide you with a quick overview of the individual working steps, you will find an identification mark on the outside top right corner of the page in question.

**Mechanical system**

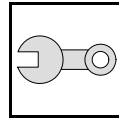

**Electrical system**

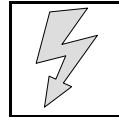

**Coolant circuit**

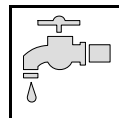

**Fuel**

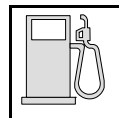

**Exhaust gas**

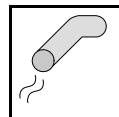

**Combustion air**

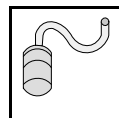

**Software**

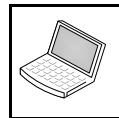

Special features are highlighted using the following symbols:



Specific risk of injury or fatal accidents.



Specific risk of damage to components.



Specific risk of fire or explosion.



Reference to general installation instructions of Webasto components or to the manufacturer's vehicle-specific documents.



Reference to a special technical feature.



The arrow in the vehicle icon indicates the position on the vehicle and the viewing angle.

**All dimensions are in mm!**  
**Tightening torque of hose clamps = 2.0 + 0.5 Nm!**  
**Tightening torque of Ejet screws, Ejet studs = 10 Nm!**

## Preliminary Work

### WARNING!

- Open the fuel tank cap and vent the fuel tank.
- Close the tank cap again.
- Disconnect the battery "earth" or "ground" connection.
- Depressurize the cooling system.
- Copy the factory number from the original type label to the duplicate type label.
- Remove years that do not apply from the duplicate label.
- Attach the duplicate label (type label) in the appropriate place.
- Completely remove the battery and the battery carrier.
- Remove the engine cover (depending on the vehicle equipment, if installed)
- Remove the air cleaner box with the intake hose and resonator (depending on the vehicle equipment, if installed)
- Detach the wheel well trim on the right and left.
- Remove the bumper.
- Remove the underride protection
- Open the right-hand fuel sender service lid.
- Remove the lower instrument panel trim on the driver's side.
- Remove radio
- Remove the A/C control panel (only with automatic air-conditioning).

Remove page 35 "Operating Instructions for End Customer" and add to the vehicle operating instructions.

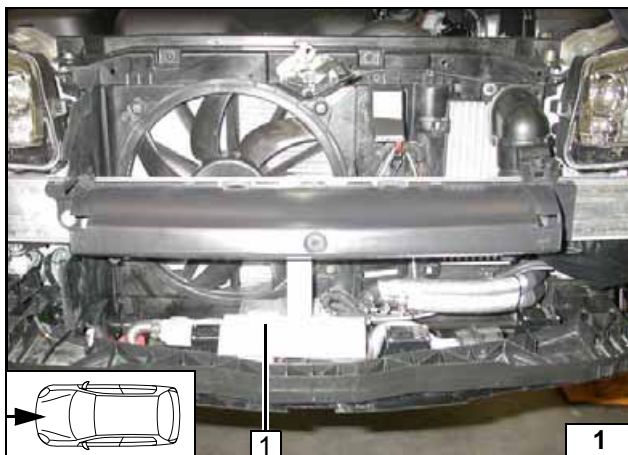

### Heater installation location

1 Heater

Installation location

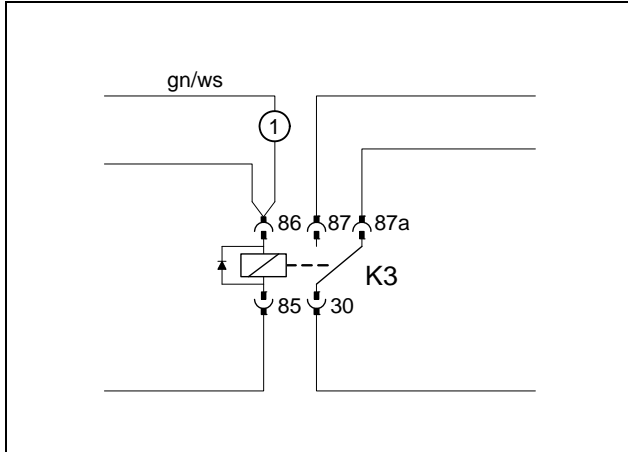

**Preparing electrical system**

**Automatic air-conditioning**

Pull 2000 mm long green/white (gn/ws) wire ① into the attached insulation hose.



**Preparing K3 relay**

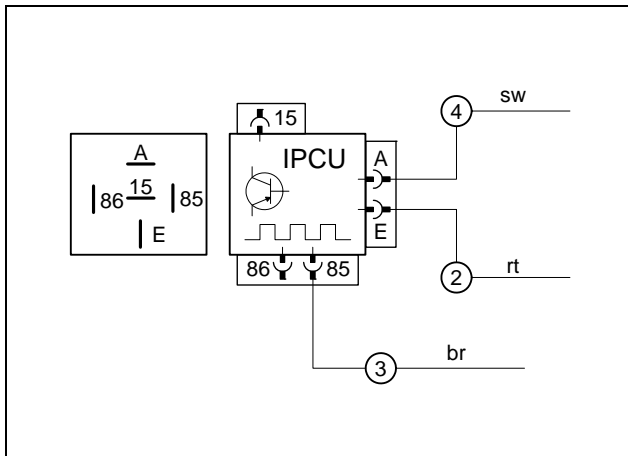

Connect wires to IPCU.  
IPCUC view on contact side!



**Preassembling IPCUC**



**Electrical system**

**Positive wire**

- 1 Red (rt) wire
- 2 Original vehicle positive support point

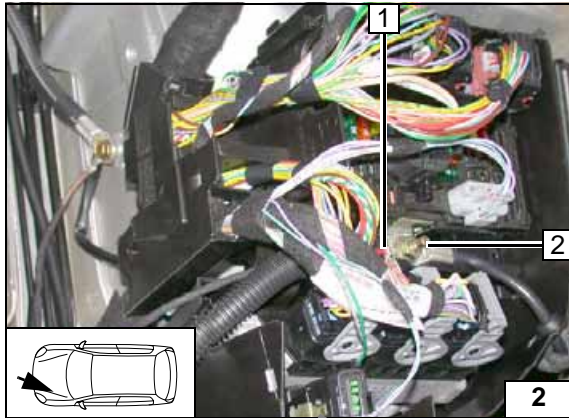

**Wiring harness pass through**

Route wiring harnesses (digital timer, fan control and red (rt) wire) in the insulation hose of the automatic A/C just behind the rubber plug 1 in the direction of the upper vehicle centre!

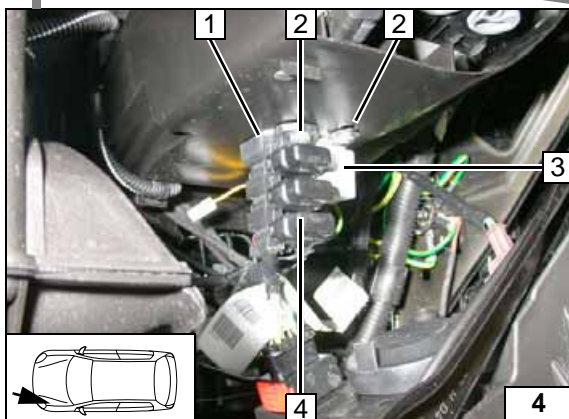
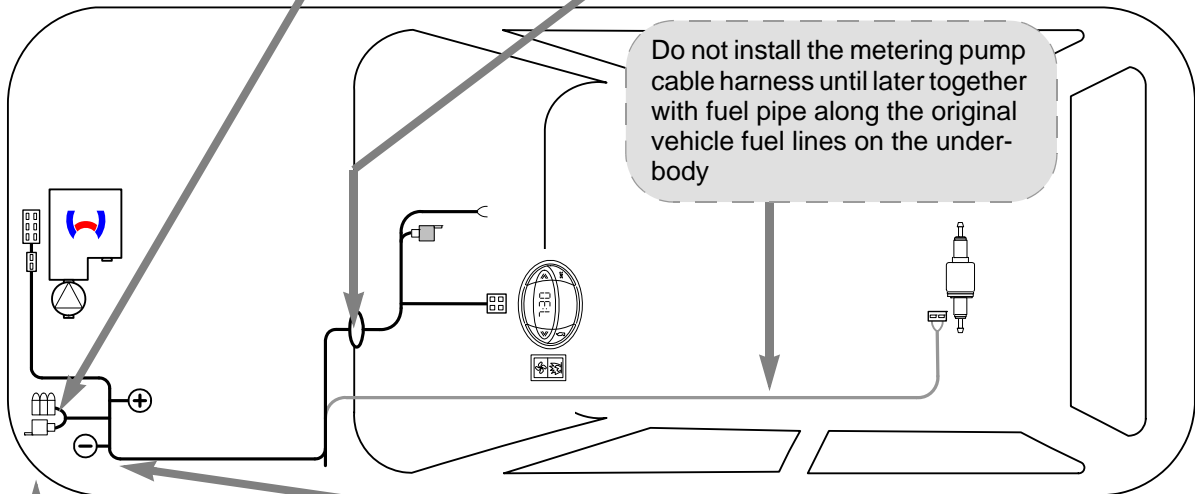
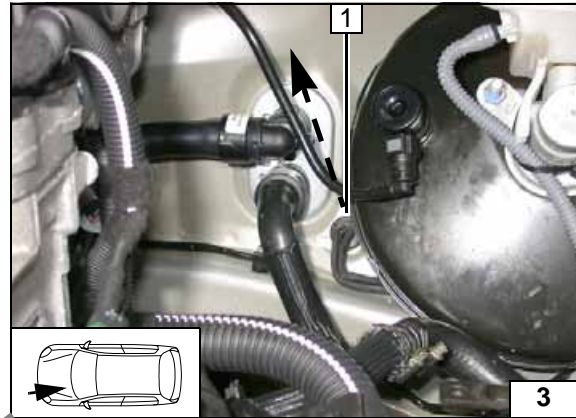

**Fuse holder, K3 relay**

- 1 Retaining plate for fuse holder
- 3 K3 relay
- 2 5.5x13 self-tapping screw; plastic nut [2x each]
- 4 F1-3 fuses mounted

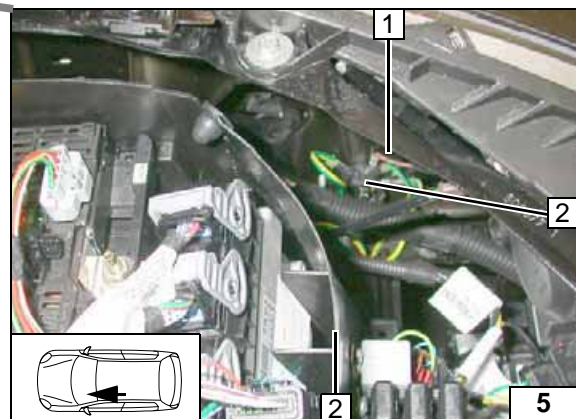

**Ground wire**

- 1 Brown (br) wire
- 2 Original vehicle ground support point



**Wiring harness installation diagram**



Fan controller for manual air conditioning

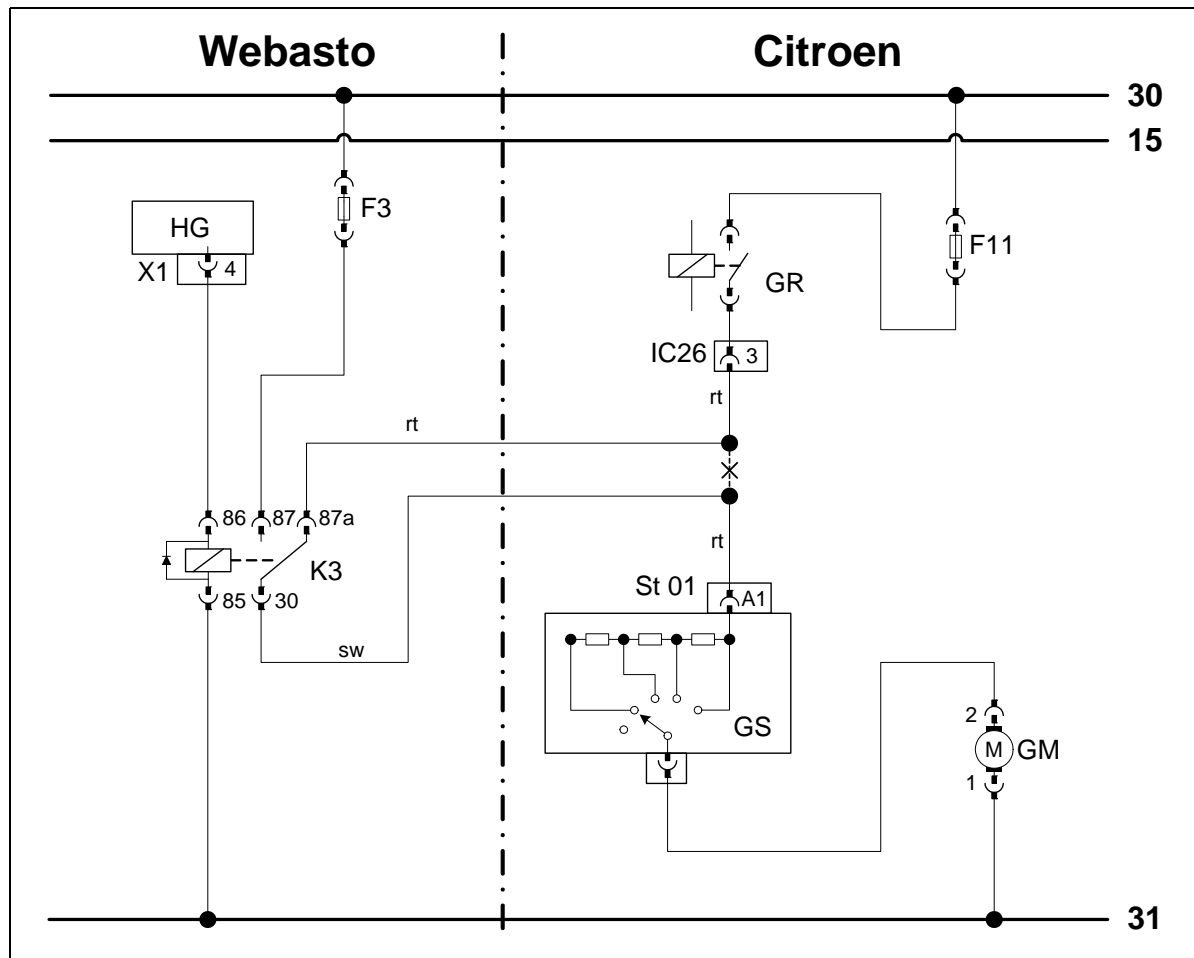

Wiring diagram

Webasto components		Vehicle components		Colours and symbols	
HG	TT-C/E/P heater	GM	Fan motor	rt	red
X1	6-pin heater connector	GR	Fan relay	sw	black
F3	Fuse	GS	Fan switch 8025		
K3	Fan relay	St 01	10-pin connector		
		IC 26	6-pin connector		
		F11	Fuse		
				X	Cutting point
				Wiring colours may vary.	

Legends

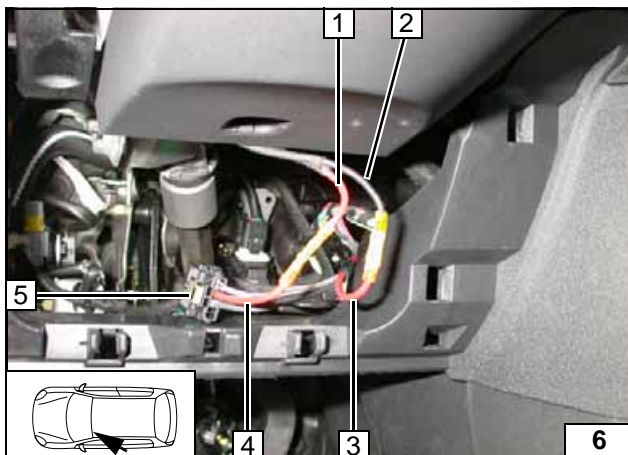

Connection to 6-pin connector 5 from IC 26. Produce connections as shown in wiring diagram.

- 1 Red (rt) wire from K3/87a
- 2 Black (sw) wire from K3/30
- 3 Red (rt) wire of fan switch
- 4 Red (rt) wire for 6-pin connector IC 26 Pin 3



Connecting fan-motor





Automatic air-conditioning fan controller



Wiring diagram

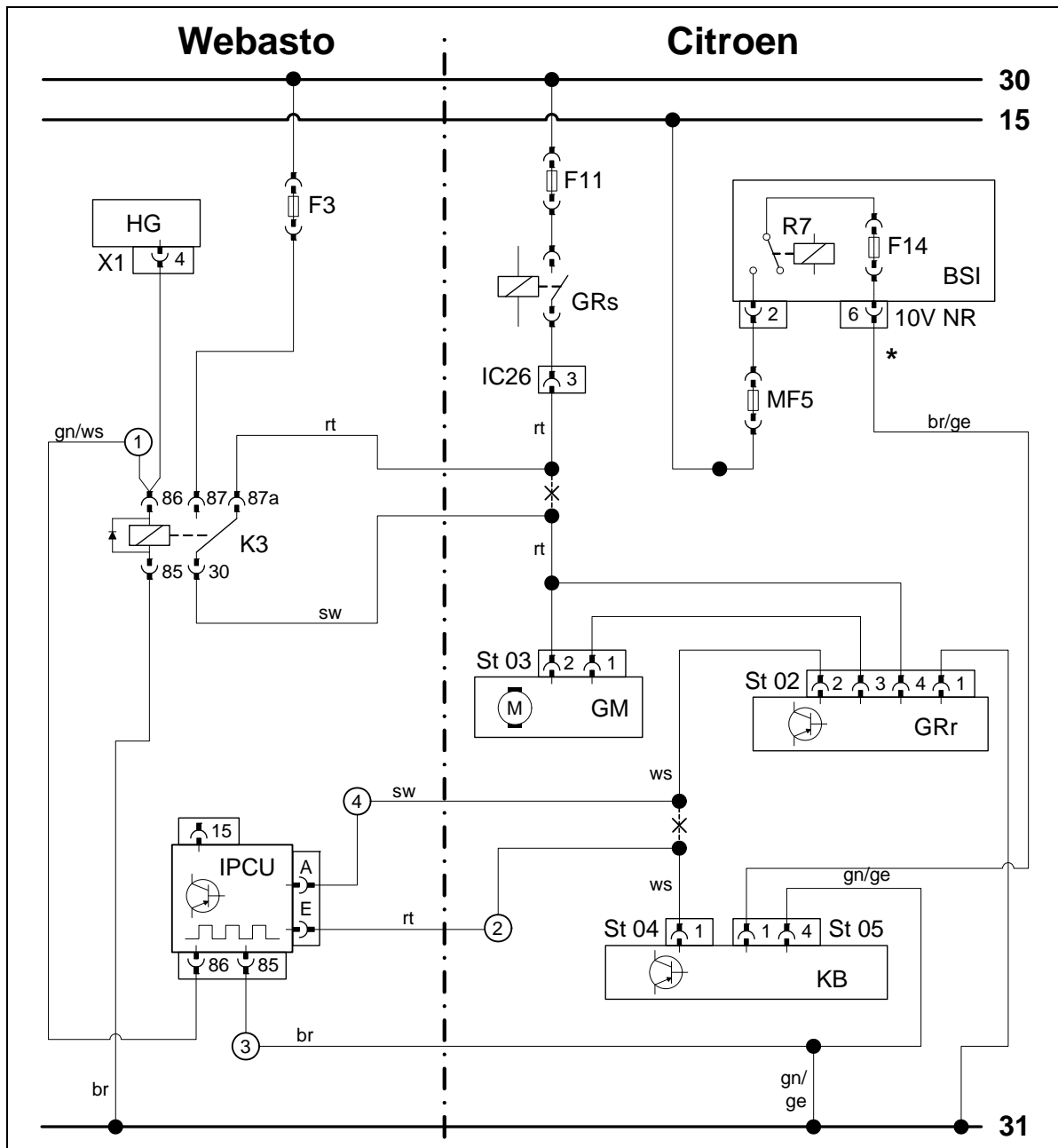

Webasto components		Vehicle components		Colours and symbols	
HG	TT-C/EP heater	GM	Fan motor 8050	rt	red
X1	6-pin heater connector	GR	Fan controller 8045	ws	white
F3	Fuse	St 02	4-pin connector GR	sw	black
K3	Fan relay	St 03	2-pin connector GM	br	brown
IPCU	Pulse width modulator	GRs	Fan relay	gn	green
		KB	8080 A/C control panel	ge	yellow
		St 04	6-pin connector, green		
		St 05	6-pin connector brown		
		IC 26	6-pin connector		
<b>IPCU adjustment values:</b>		BSI	Central switching unit		
Duty cycle:	100%	10 V NR	BSI connector	*	15 mm terminal from BSI delayed power-off
Frequency:	14 kHz	GM	Fan motor 8050		
Voltage:	1.7 V	GR	Fan controller 8045	X	Cutting point
Function:	High-side	St 02	4-pin connector GR	Wiring colours may vary.	

Legends

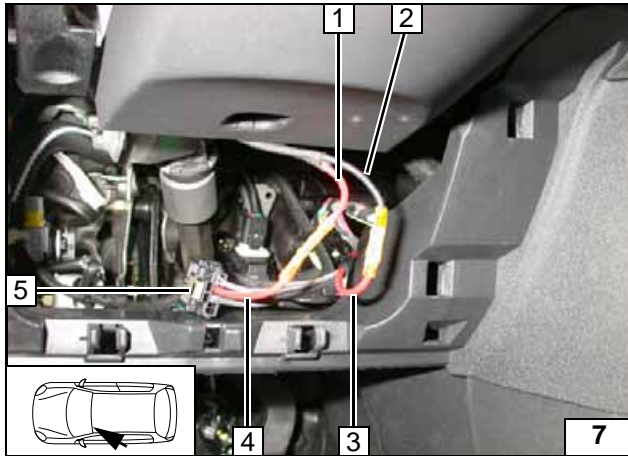

Connection to 6-pin connector **5** from IC 26. Produce connections as shown in wiring diagram.

- 1 Red (rt) wire from K3/87a
- 2 Black (sw) wire from K3/30
- 3 Red (rt) wire of fan switch
- 4 Red (rt) wire for 6-pin connector IC 26 Pin 3



**Connect-  
ing fan-mo-  
tor**

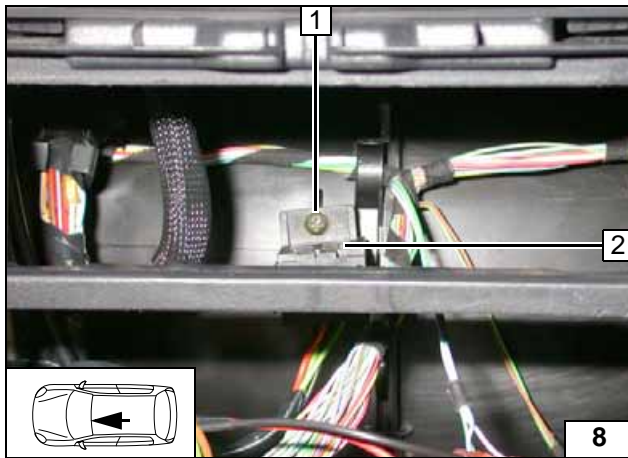

Before installing, connect green/white (gn/ws) wire ① from K3/86 to base of IPCU terminal 86.

- 1 3.5x9.5 self-tapping screw; washer
- 2 Base of IPCU



**Installing  
base from  
IPCU**

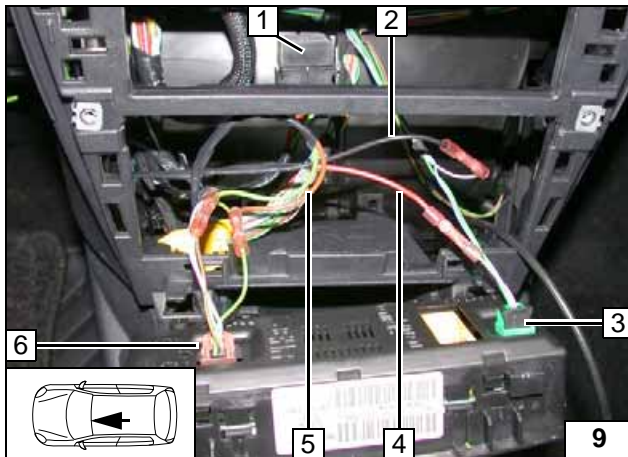

Connection to green 6-pin connector **3** and brown 6-pin connector **6** of A/C control panel. Secure IPCU base with adhesive tape!

- 1 IPCU mounted
- 2 Black (sw) wire ④ of IPCU/A to white (ws) wire of motor controller Pin 2
- 4 Red (rt) wire ② of IPCU/E to white (ws) wire of 6-pin connector Pin 1
- 5 Slide Brown (br) wire ③ of IPCU/85 onto green/yellow (gr/ge) wire of brown 6-pin connector Pin 4



**Connect-  
ing A/C  
control  
panel**

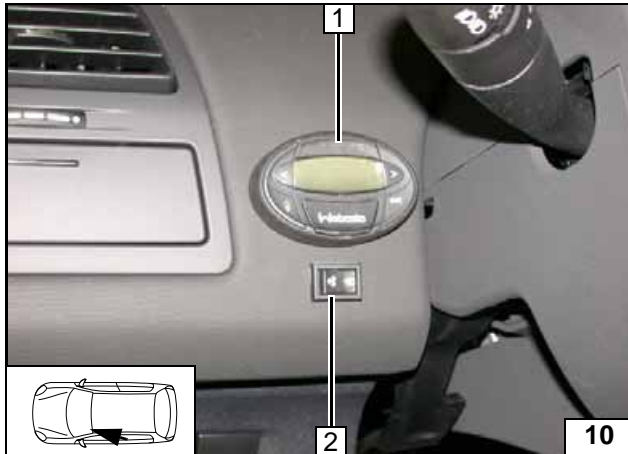

**Digital timer, summer/winter switch option**

The installation location according to this or the following figure is only a recommendation. Agree upon with final customer before installing.

**Variant 1**

- 1 Digital timer
- 2 Summer/winter switch, drilled hole 12 mm dia.

**Variant 2**

- 1 Summer/winter switch, drilled hole 12 mm dia.
- 2 Digital timer

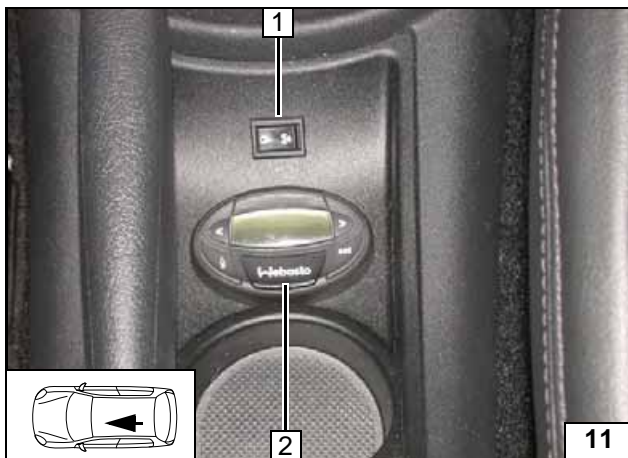

**Remote option (Telestart)**

In case of simultaneous installation with Thermo-Call, the Telestart receiver is fastened under the bracket 4.

- 1 Receiver
- 2 Receiver bracket
- 3 M5x16 bolt, flanged nut, existing hole

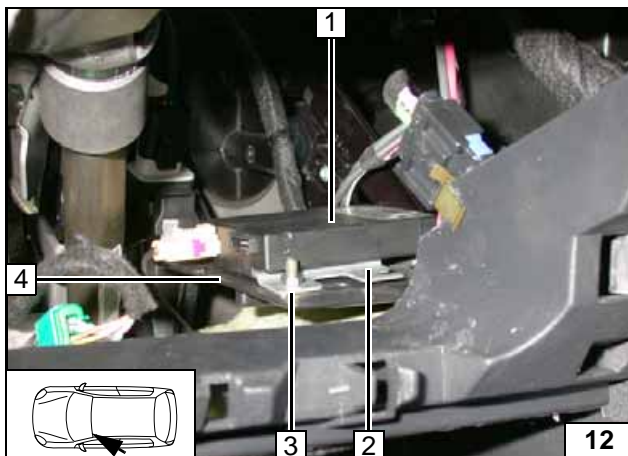

- 1 Antenna

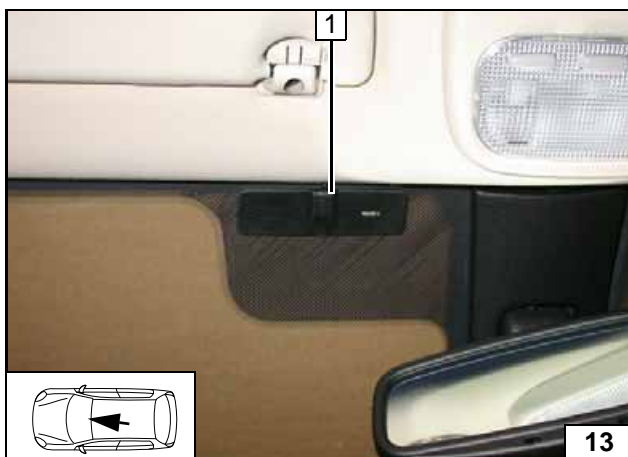

**Installing digital timer**



**Installing digital timer**



**Installing receiver**

**Installing antenna**

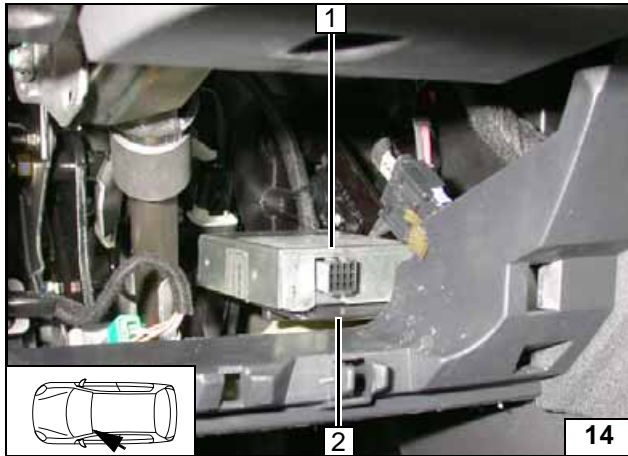

**Remote option Thermo Call**

Secure the receiver of Thermo Call 1 on the bracket 2 with adhesive tape.



**Installing receiver**

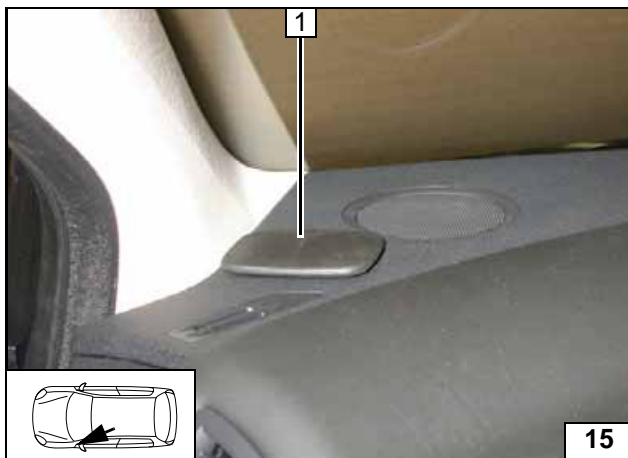

1 Antenna

**Installing antenna**

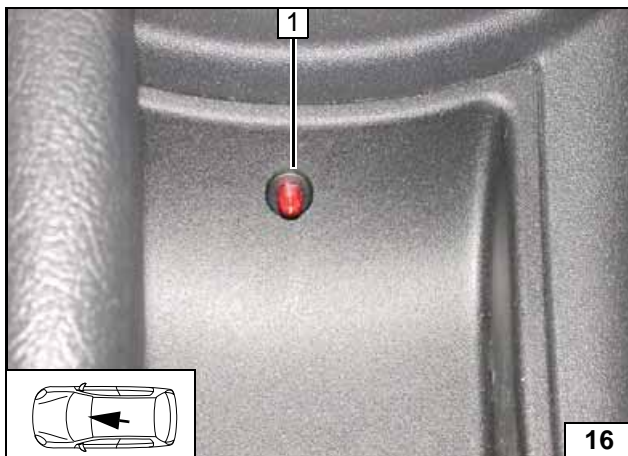

1 Pushbutton

**Installing push button**

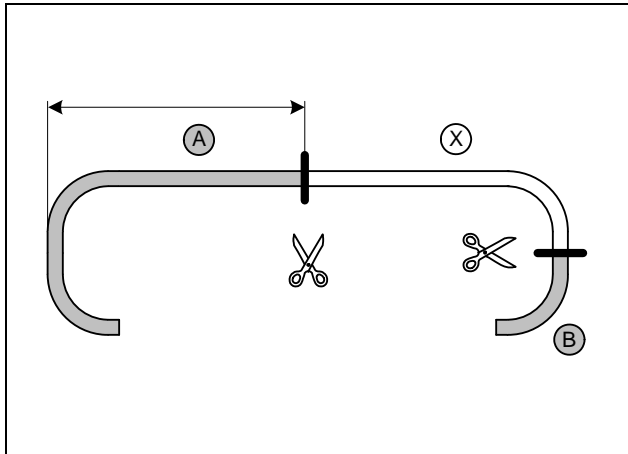
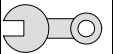

**Preparing heater**

Hose **B** = 90° elbow  
Discard section **X**

**A** = 1240 mm



**Cutting coolant hoses to length**

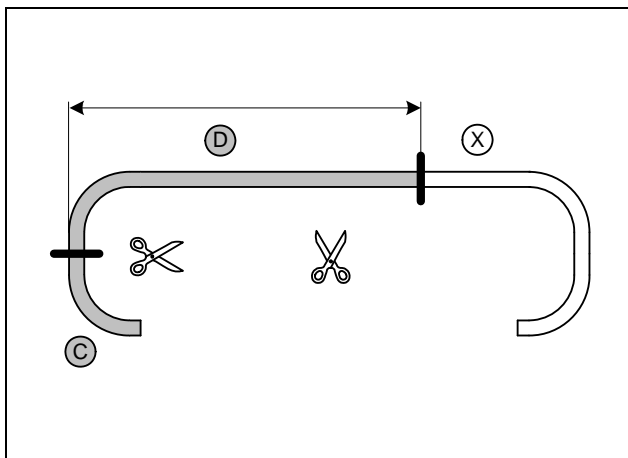

Hose **C** = 90° elbow  
Discard section **X**

**D** = 1240 mm



**Cutting coolant hoses to length**

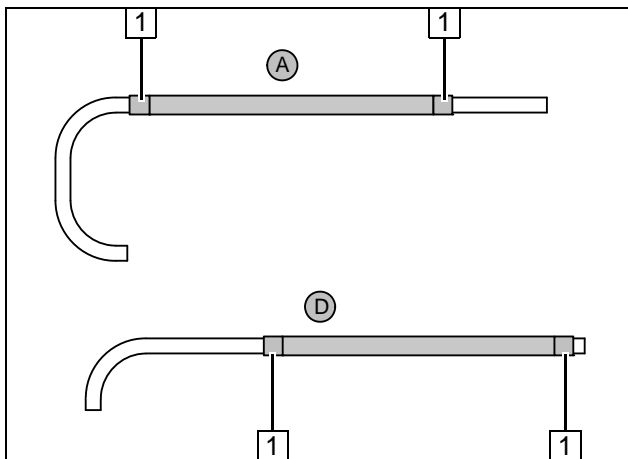

Push braided protection hoses onto hose **A** and **D** and cut to length.  
Cut heat shrink plastic tubing to length and shrink to size.

**1** 25 mm long heat shrink plastic tubing [4x]



**Preparing coolant hoses**

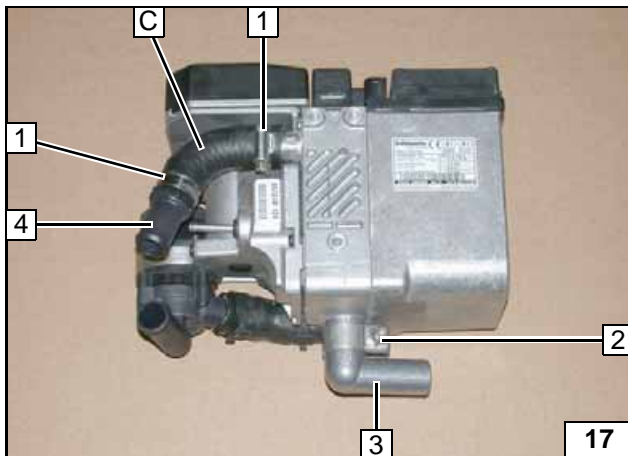

- 1** 27 mm dia. hose clamp [2x]
- 2** Hose clamp
- 3** Exhaust manifold
- 4** 20x20 connecting pipe

**Preassembling heater**

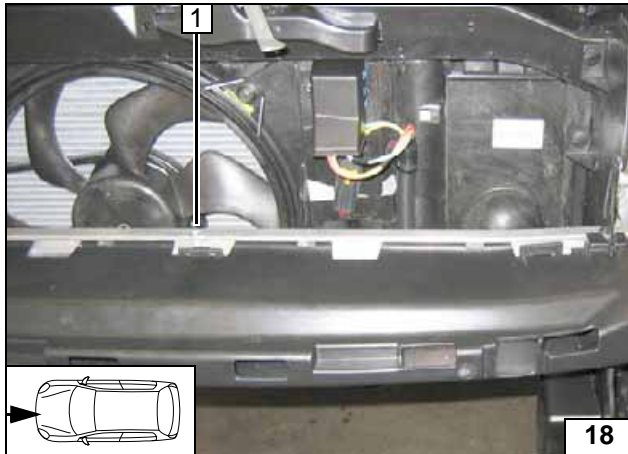
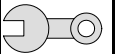

**Preparing installation location**

Hole at the centre of the bumper.

- 1 Drill 9.1 mm dia. hole; rivet nut



**Mounting rivet nut**

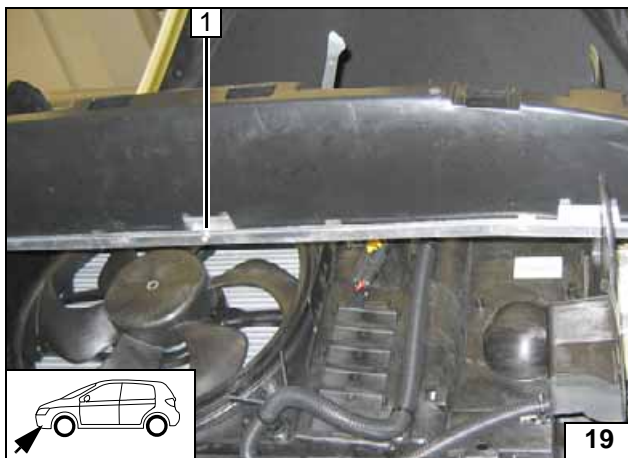

Hole at the centre of the bumper.

- 1 Drill 9.1 mm dia. hole; rivet nut



**Mounting rivet nut**

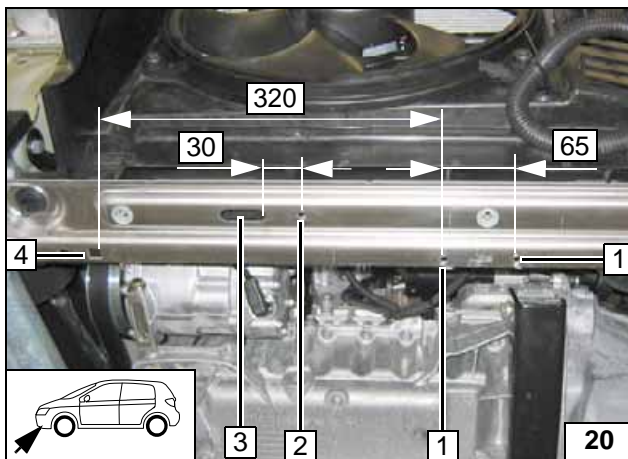

Rectangular recess at Position 4, recess for oblong hole at Position 3!

- 1 7 mm dia. hole [2x] (centered from bar)
- 2 7 mm dia. hole



**Holes in the radiator cross member**

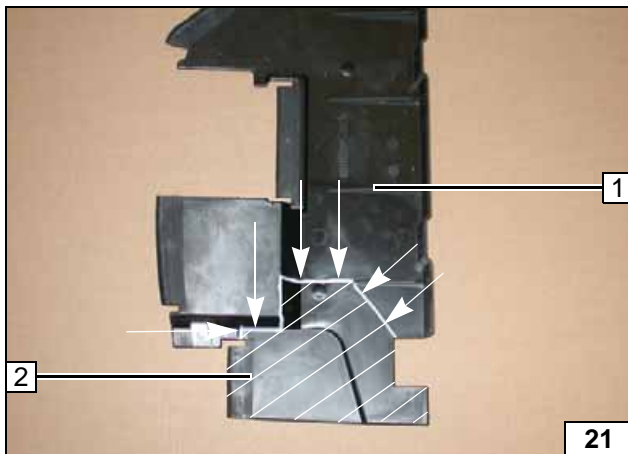

If left partition wall 1 exists, cut it off at the markings.

- 2 Discard section



**Cutting out partition wall**

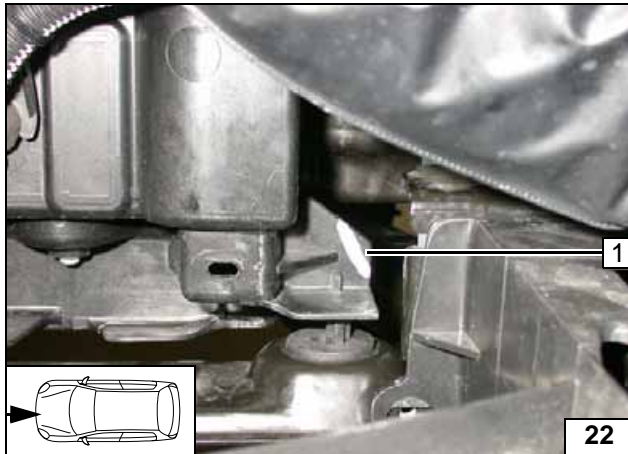
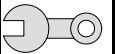

**2.0l gasoline**

Cut away edge 1 at marking and discard.



**Cutting away edge on radiator cross member**

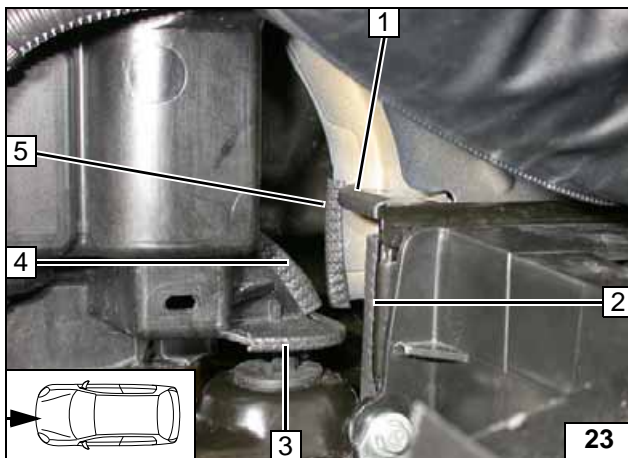

Cut consecutive 500 mm ends from edge protection provided and install.

- 1 50 mm edge protection
- 2 70 mm edge protection
- 3 130 mm edge protection
- 4 60 mm edge protection
- 5 60 mm edge protection



**Installing edge protection**

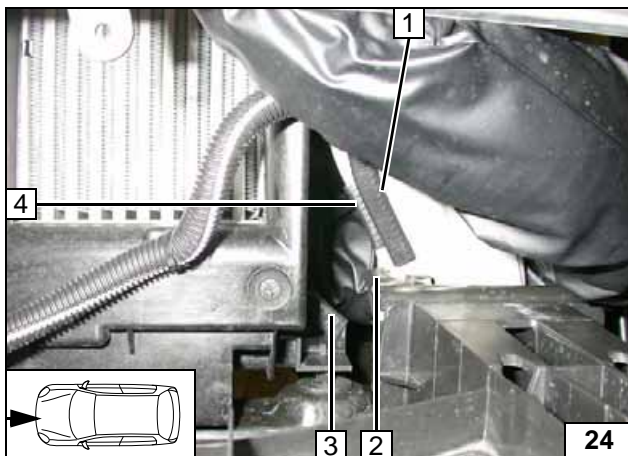

**All vehicles except 2.0l Gasoline**

Cut 4 consecutive 500 mm ends from edge protection provided and install.

- 1 60 mm edge protection
- 2 40 mm edge protection
- 3 40 mm edge protection
- 4 40 mm edge protection



**Installing edge protection**

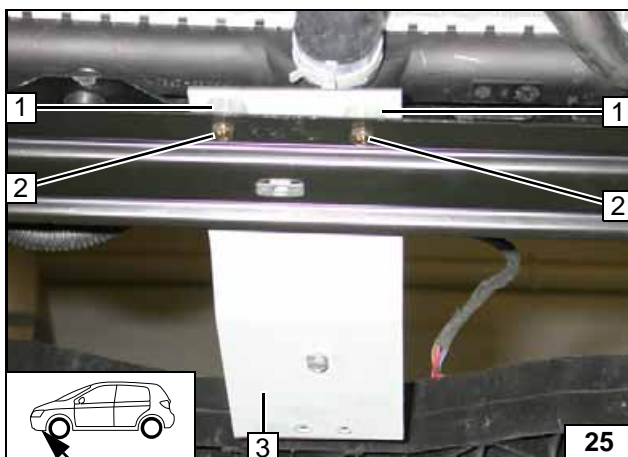

**Installing bracket**

Insert one 10 mm shim 1 between bracket 3 and cross member!

- 2 M6x20 bolt, 10 mm shim, flanged nut [2x each]

**Installing bracket**

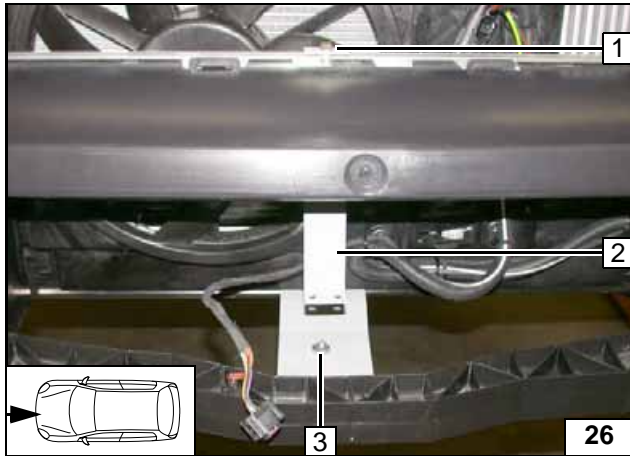
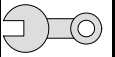

- 1 M6x20 bolt, spring lockwasher
- 2 Strut
- 3 E-jot screw, washer [2x], pin lock

**Installing strut**

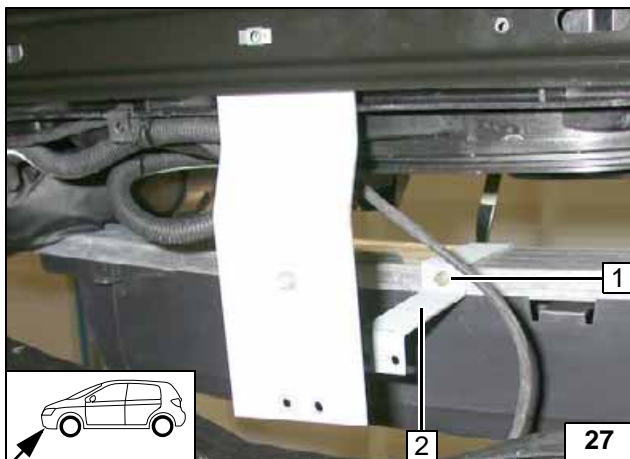

- 1 M6x20 bolt, spring lockwasher
- 2 Strut

**Fastening strut**

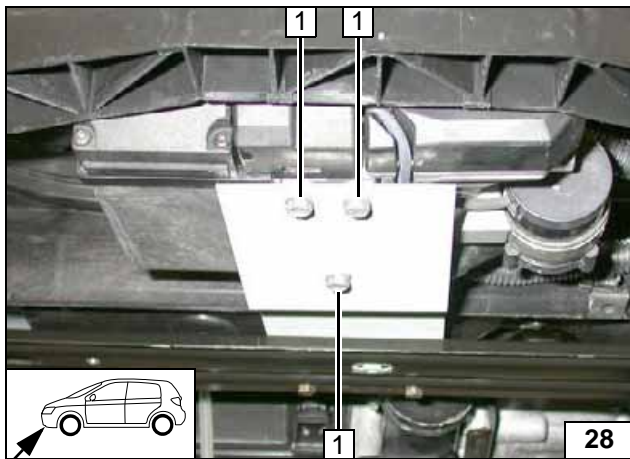

**Installing heater**

Mount wiring harness of heater before installation.

- 1 E-jot screw [3x]



**Installing heater**

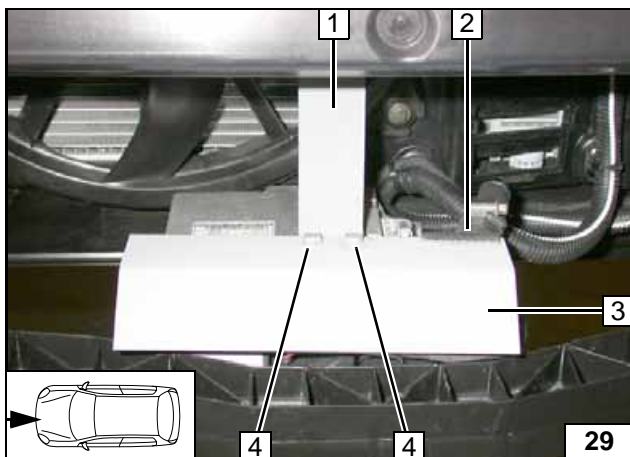

- 1 Strut
- 2 50 mm edge protection
- 3 Wind deflector plate
- 4 E-jot screw [2x]

**Installing heater**



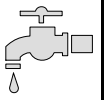



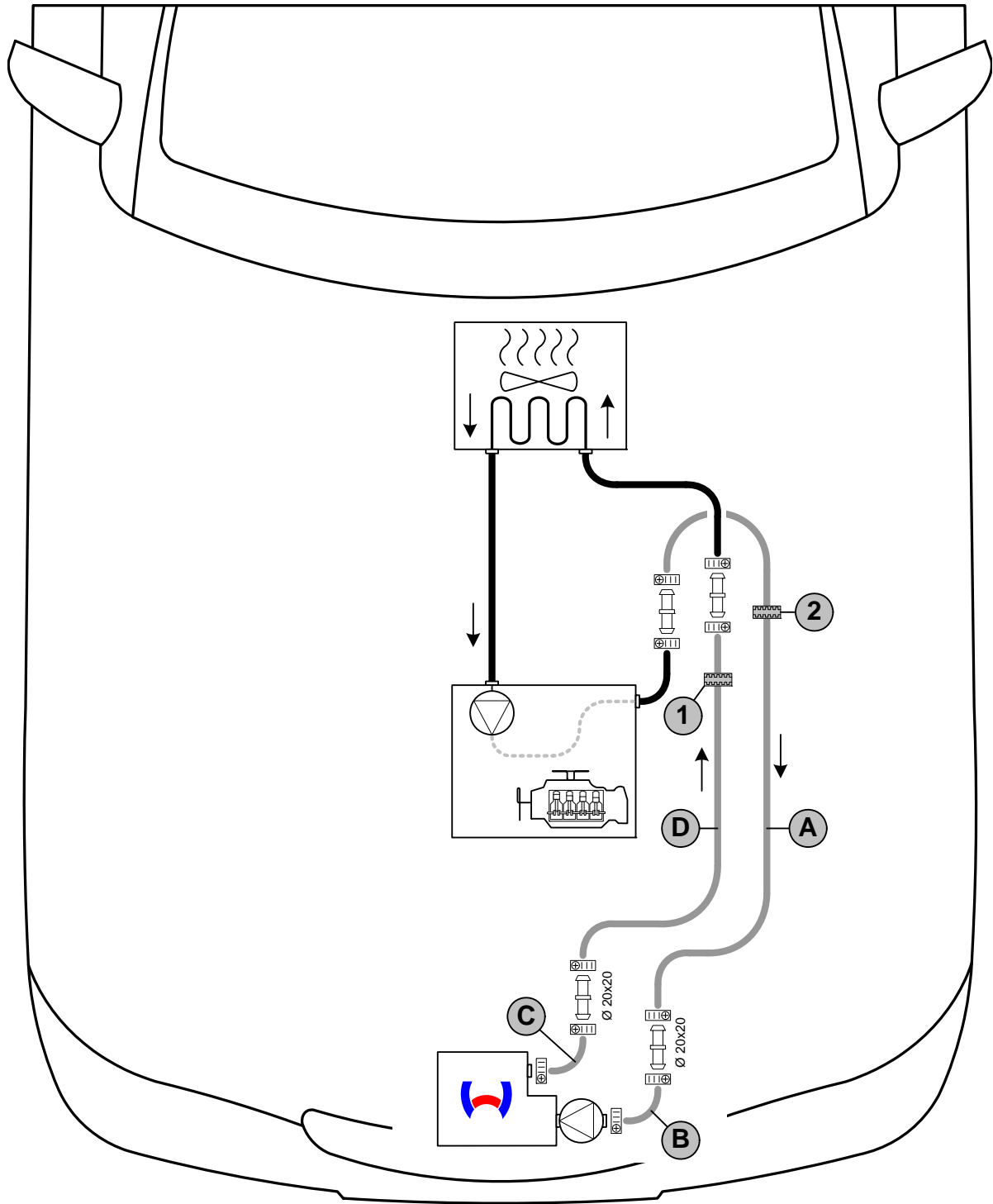

**Coolant circuit**

**WARNING!**

Any coolant running off should be collected using an appropriate container! Route coolant hoses kink-free! Unless specified otherwise, always fasten using cable ties. Position clamps so that no other hose can be damaged! When installing the hoses, the heater must be filled with coolant. The connection should be "inline" based on the following diagram:



Hose routing diagram

All hose clamps  = 20-27 mm dia.! All not designated connecting pipes  as follows:  
**1.4 and 1.6l Gasoline** = 15x20 dia or 18x20 dia! **2.0l Gasoline** and **1.6l Diesel** = 18x20 dia  
**2.0 liter diesel** = 20x20 dia. **1** = Black (sw) rubber isolator  (Gasoline). **2** = Black (sw) rubber isolator  (Diesel).



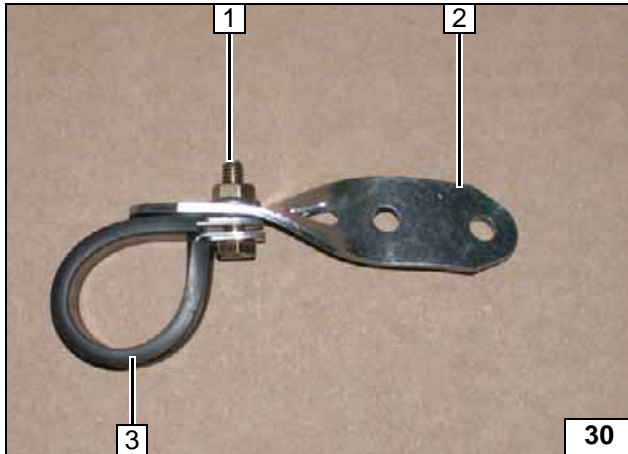
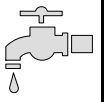

Turn perforated bracket 2 by approx. 75° on longitudinal axis.

- 1 M6x20 bolt, flanged nut
- 2 Perforated bracket
- 3 Rubber-coated pipe clamp



**Preparing perforated bracket**

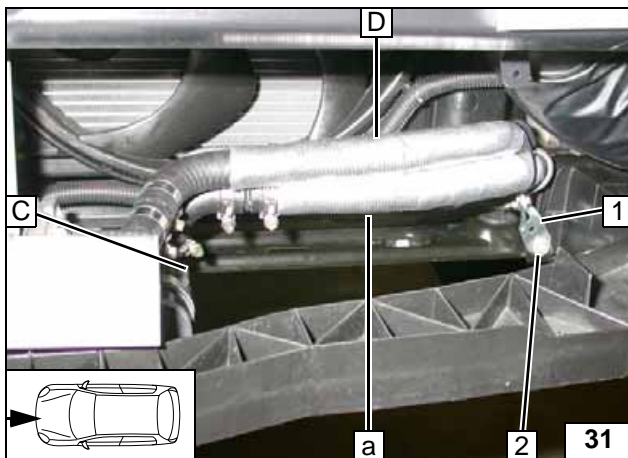

Sliding on heat protection hoses. Route hoses A and D through pass-through in the cooler at the left of the heater. When doing so, guide hose A through rubber-coated p-clamp.

- 1 Prepared perforated bracket
- 2 Original vehicle bolt



**Installing coolant hoses**

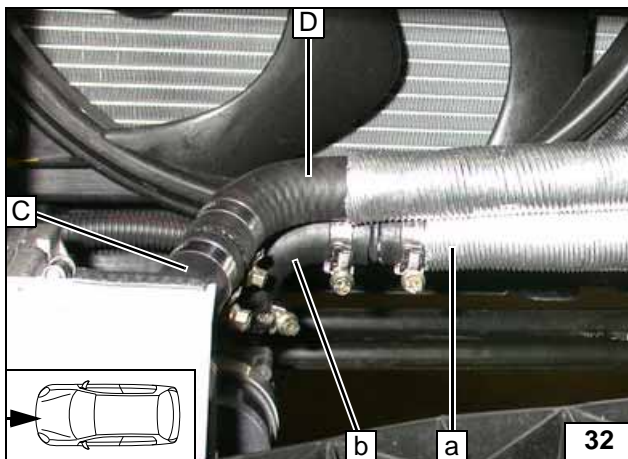

**Connection to heater**

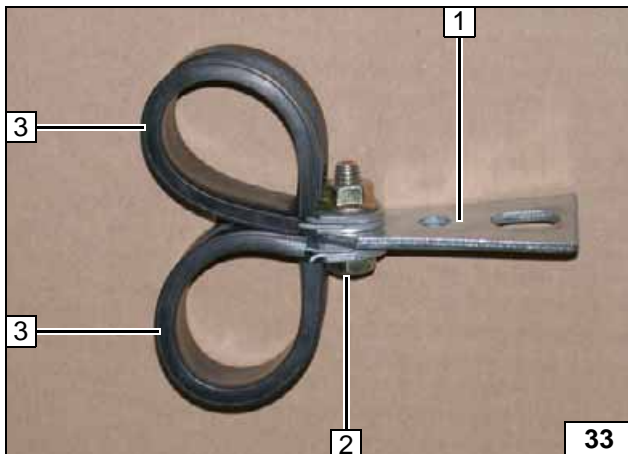

Cut perforated bracket to approx. 58 mm.

- 1 Perforated bracket
- 2 M6x20 bolt, flanged nut
- 3 Rubber-coated p-clamp [2x]



**Preparing perforated bracket**

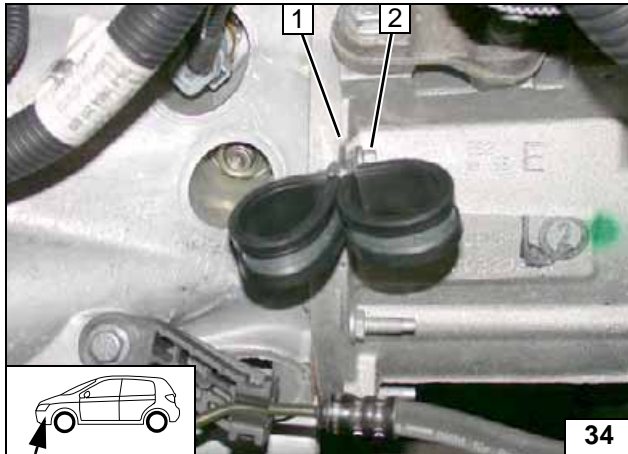
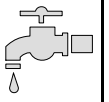

Fasten perforated bracket on transmission block.

- 1 Prepared perforated bracket
- 2 Original vehicle bolt



**Installing perforated bracket**

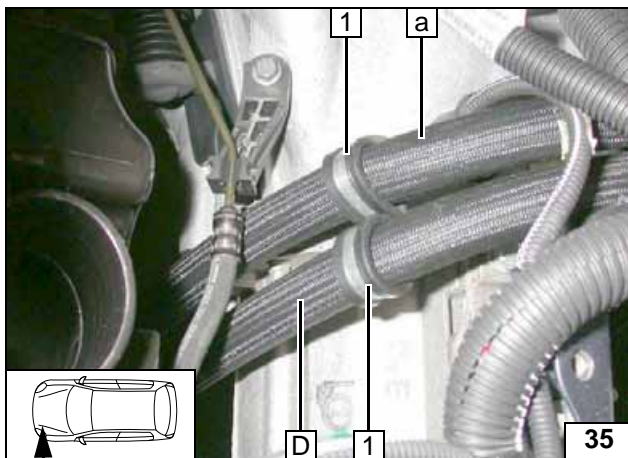

**Gasoline**

Route hose **A** and **D** through rubber-coated p-clamps.

- 1 Rubber-coated p-clamp [2x]



**Routing to cutting point**

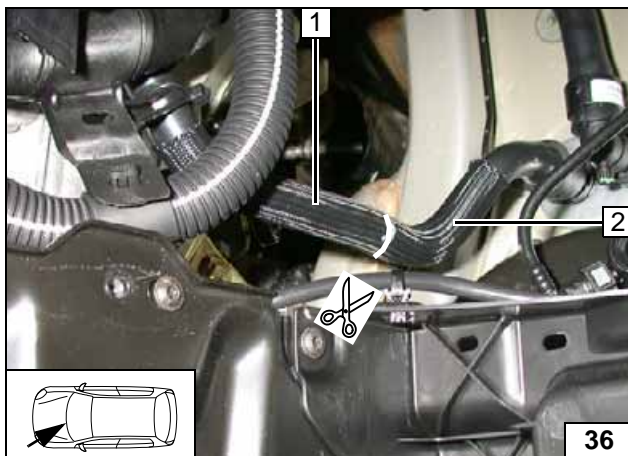

**1.4 and 1.6l Gasoline**

Remove braided protection hose in area of cutting point. Disconnect hose from engine outlet to heat exchanger inlet with hose clamping pliers.

- 1 Engine-outlet hose section
- 2 Hose section of heat exchanger inlet



**Cutting point**

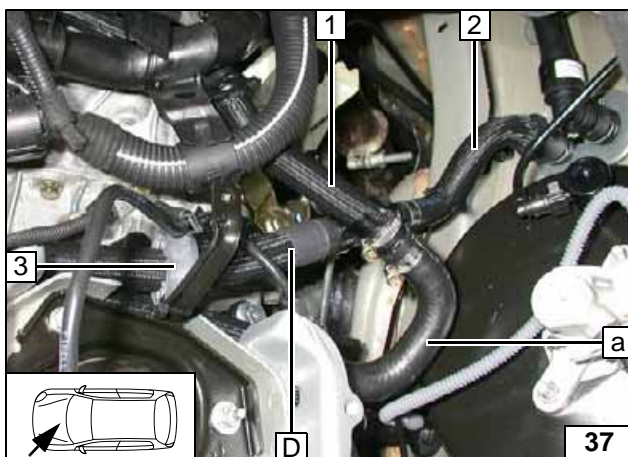

Before installation, push black (sw) rubber isolator **3** onto hose **D**.

- 1 Engine-outlet hose section
- 2 Hose section of heat exchanger inlet



**Connecting heat exchanger inlet and engine outlet**

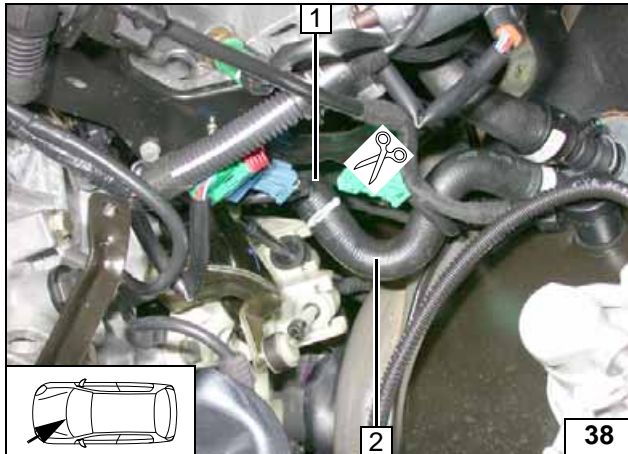
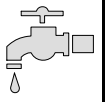

**2.0l gasoline**

Disconnect hose from engine outlet to heat exchanger inlet with hose clamping pliers.

- 1 Engine-outlet hose section
- 2 Hose section of heat exchanger inlet

**Cutting point**

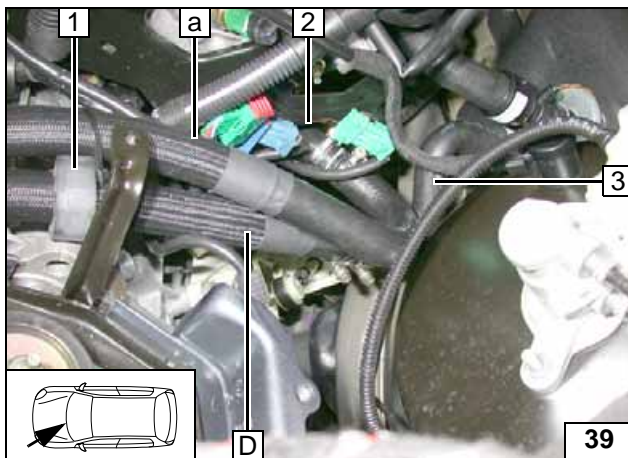

Before installation, push black (sw) rubber isolator 1 onto hose D.

- 2 Engine-outlet hose section
- 3 Hose section of heat exchanger inlet

**Connecting heat exchanger inlet and engine outlet**

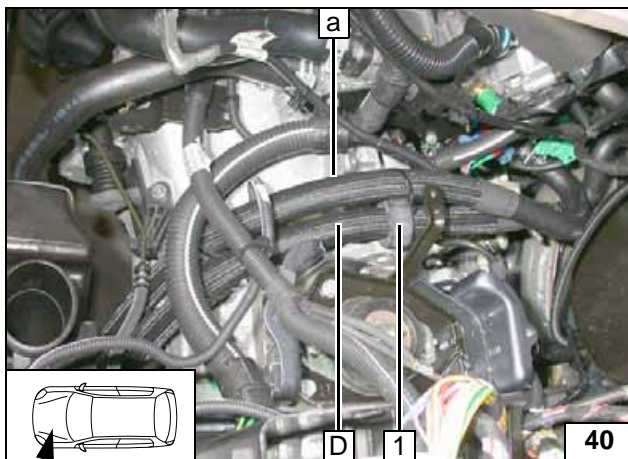

**Gasoline**

Figure shows 2.0 l gasoline. Fasten rubber isolator on hose A with cable tie.

- 1 Black (sw) rubber isolator

**Routing in engine compartment**

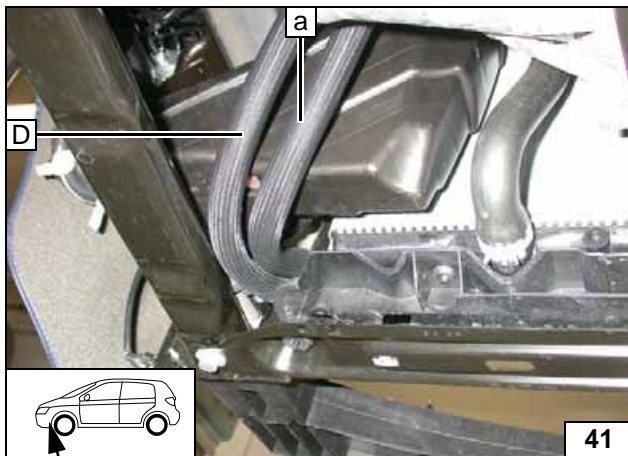
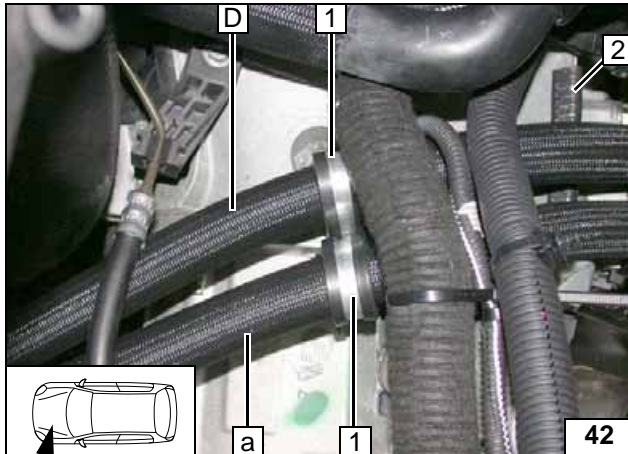
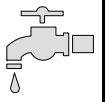

Figure shows 2.0 l gasoline. Check the position of the components; adjust if necessary. Check that they have free clearance.

**Positioning hose A and D**





**1.6l diesel**

Route hose **A** and **D** through rubber-coated p-clamps.

- 1 Rubber-coated p-clamp [2x]
- 2 100 mm edge protection



**Routing to cutting point**

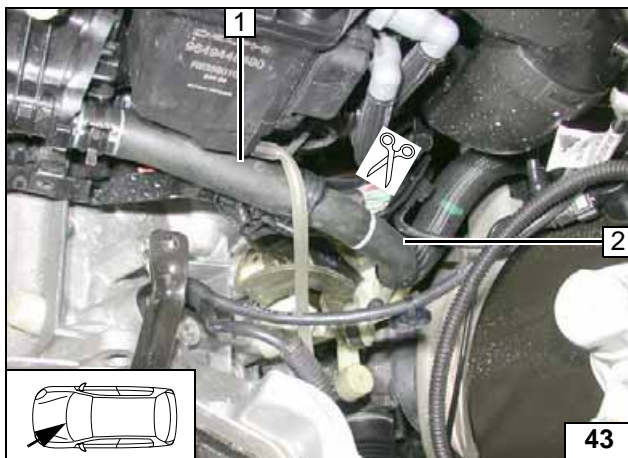

Disconnect hose from engine outlet to heat exchanger inlet with hose clamping pliers.

- 1 Engine-outlet hose section
- 2 Hose section of heat exchanger inlet



**Cutting point**

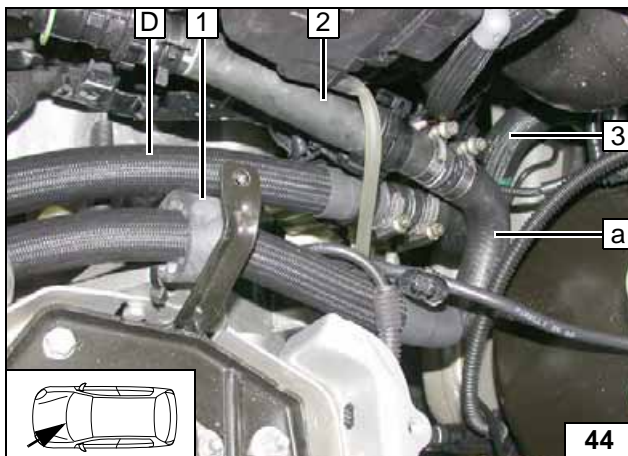

Before installation, push black (sw) rubber isolator **1** onto hose **A**.

- 2 Engine-outlet hose section
- 3 Hose section of heat exchanger inlet



**Connecting heat exchanger inlet and engine outlet**

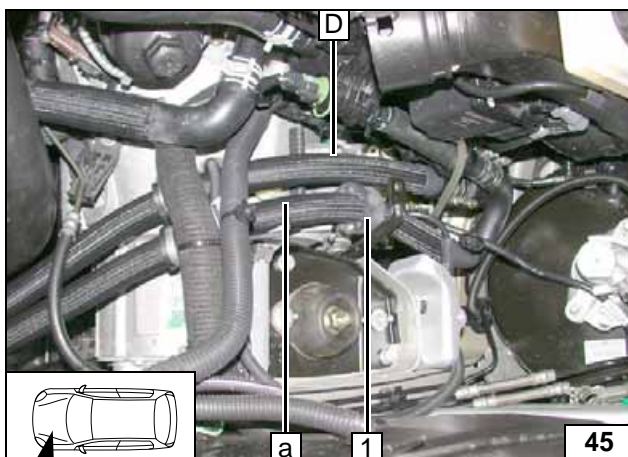

Fasten black (sw) rubber isolator **1** on hole of transmission block with cable tie.



**Routing in engine compartment**

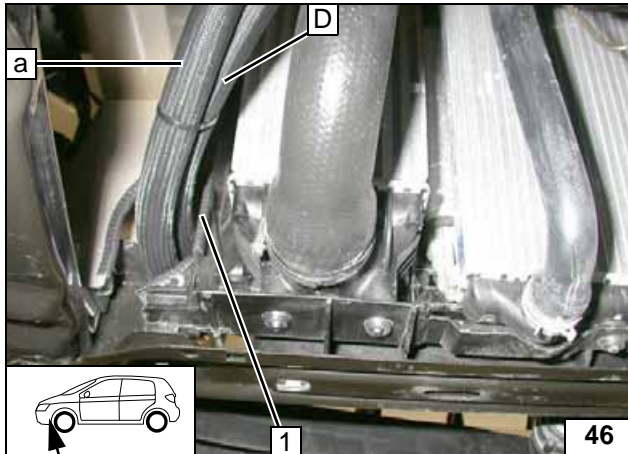
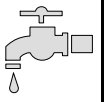

Check the position of the components; adjust if necessary. Check that they have free clearance.

- 1 50 mm edge protection



**Positioning hose A and D**

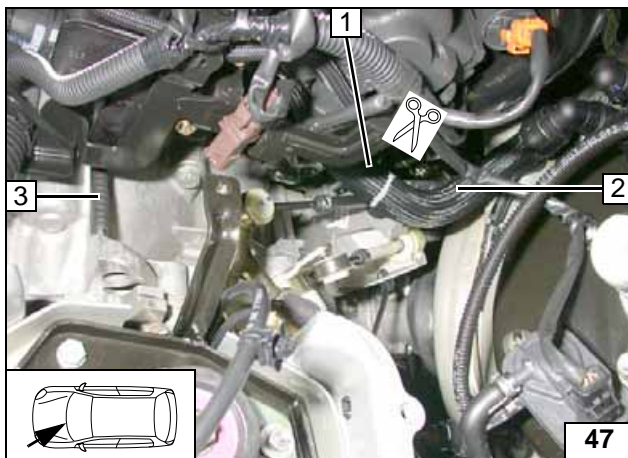

**2.0l diesel**

Remove braided protection hose in area of cutting point.

- 1 Engine-outlet hose section
- 2 Hose section of heat exchanger inlet
- 3 50 mm edge protection



**Cutting point**

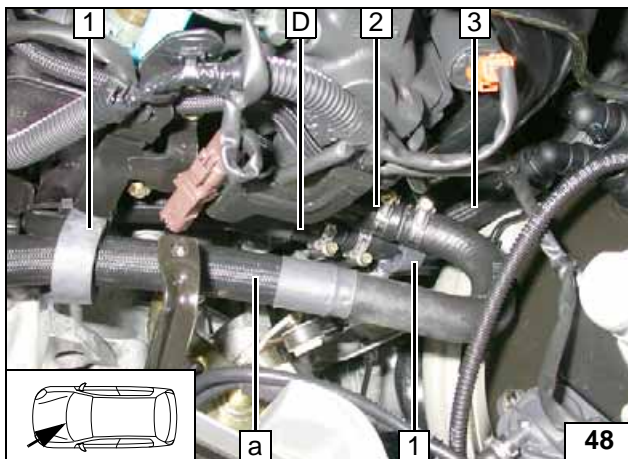

Before installing, push black (sw) rubber isolator 1 onto hose A and onto hose section of heat exchanger inlet 3.

- 2 Engine-outlet hose section



**Connecting heat exchanger inlet and engine outlet**

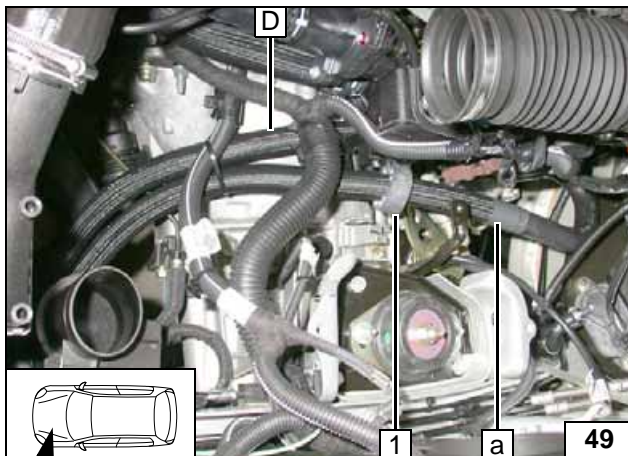

Fasten black (sw) rubber isolator 1 on original vehicle wiring harness bracket with cable tie.



**Positioning hose A and D**

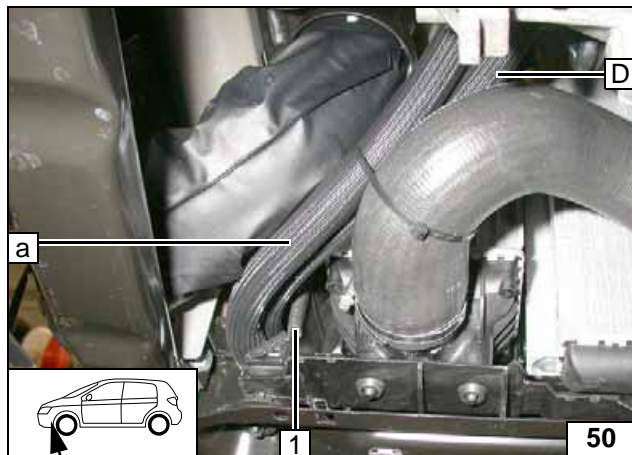

Check the position of the components; adjust if necessary. Check that they have free clearance.

1 50 mm edge protection



**Positioning hose A and D**



**Fuel**

**CAUTION!**

Open the vehicle's fuel tank cap, ventilate the tank and then re-close the tank lock.

Catch any fuel running off with an appropriate container.

Install fuel line and metering-pump wiring harness so that they are protected against stone impact. Unless specified otherwise, always fasten using cable ties. Mount the fuel line and wiring harness with rub protection on sharp edges.

**WARNING!**

The fuel line and wiring harness are routed to the metering pump in as shown in the wiring harness routing diagram.

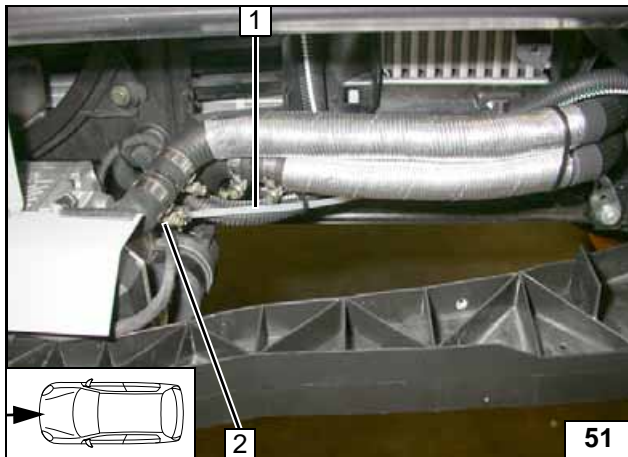

- 1 Fuel line
- 2 Hose section, 10 mm dia. clamp [2x]

Connect-  
ing heater

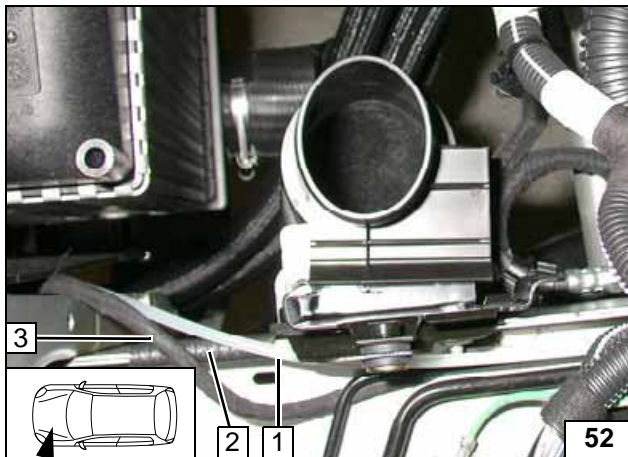

Route wiring harness of metering pump **3** and fuel line **1** on the side member to the firewall and further to the underbody.

- 2 70 mm edge protection



Installing  
lines

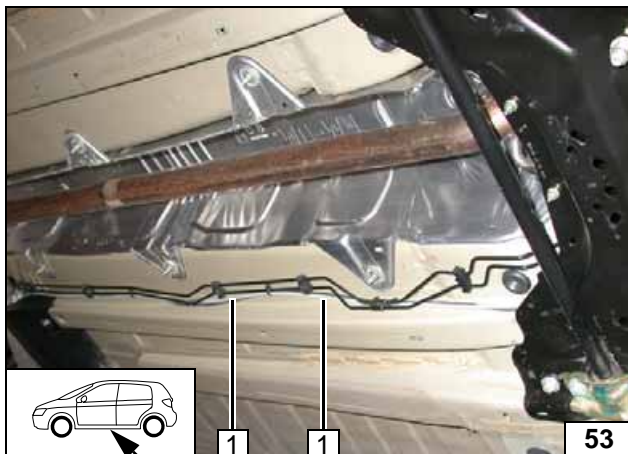

- 1 Fuel line
- 2 Metering pump wiring harness

Installing  
lines



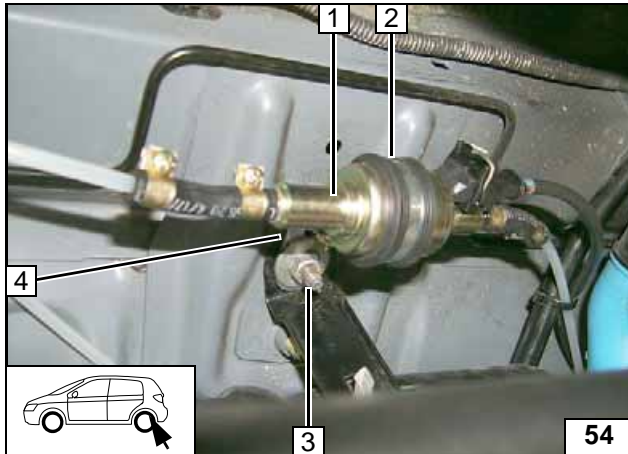

Secure angle bracket **4** with oblong hole and large diameter washer on the stud bolt of the tank suspension **3**.

- 1** Metering pump
- 2** Rubber-coated p-clamp, silent block, flanged nut [2x] on angle bracket



**Installing metering pump**

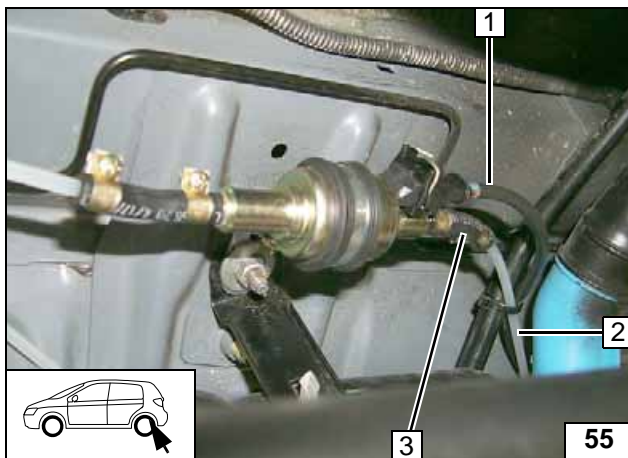

- 1** Wiring harness of metering pump, connector mounted
- 2** Fuel line from heater
- 3** Hose section, 10 mm dia. clamp [2x]



**Connecting metering pump**

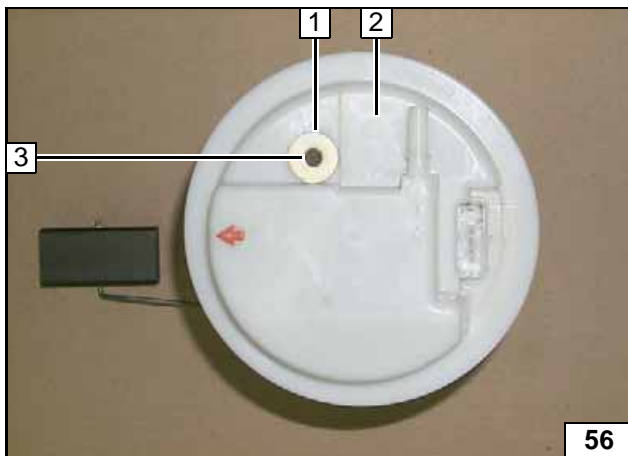

**Gasoline**

One differentiates between 2 variants, depending on the vehicle equipment.

**Variant 1**

Remove fuel-tank sending unit **2** in accordance with manufacturer's specifications.

- 1** Large diameter washer
- 3** Copy hole pattern, 6 mm dia. hole



**Removing fuel**

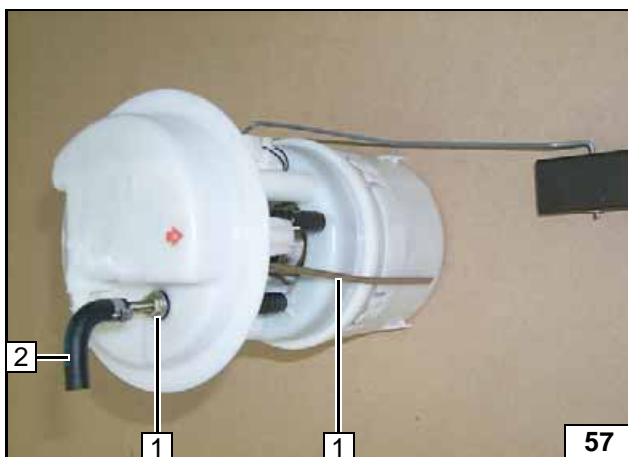

Shape fuel standpipe **1** according to template, cut to length and install. Moulded hose section of 3.5 mm dia on fuel tank standpipe.

- 2** 3.5x4.5 dia moulded hose; 8 mm dia clamp



**Installing fuel standpipe**

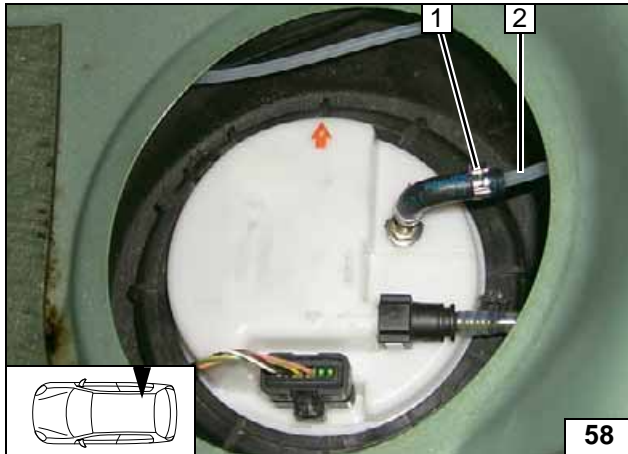

Install fuel-tank sending unit according to manufacturer's specifications. Replace sealing ring!

- 1 clamp of 10 mm dia
- 2 Fuel line



Connect-  
ing fuel  
line

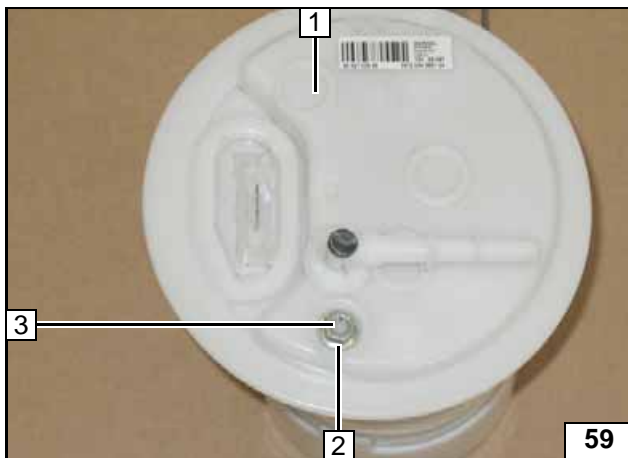

**Variant 2**  
Remove fuel-tank sending unit 1 in accordance with manufacturer's specifications.

- 2 M6 flanged nut
- 3 Copy hole pattern, 6 mm dia. hole



Removing  
fuel



Shape fuel standpipe 2 according to template, cut to length and install. Moulded hose section of 3.5 mm dia on fuel tank standpipe.

- 1 3.5x4.5 dia moulded hose; 8 mm dia clamp



Installing  
fuel stand-  
pipe

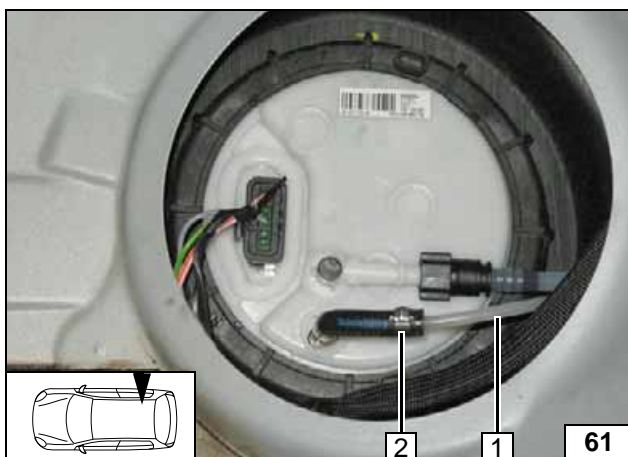

Install fuel-tank sending unit according to manufacturer's specifications. Replace sealing ring!

- 1 Fuel line
- 2 clamp of 10 mm dia



Connect-  
ing fuel  
line

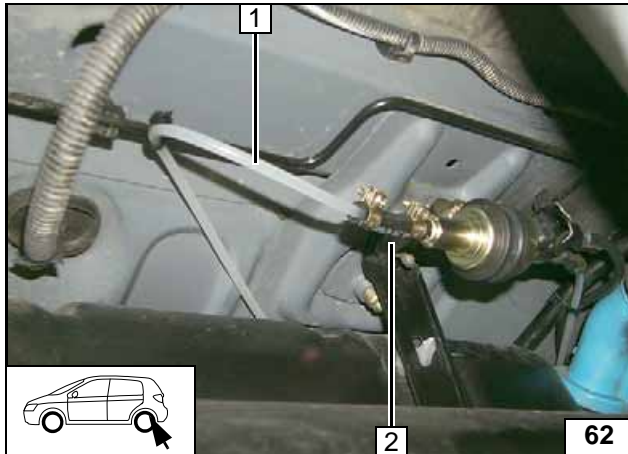
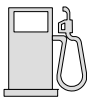

Check the position of the components; adjust if necessary. Check that they have free clearance.

- 1 Fuel line
- 2 Hose section, 10 mm dia. clamp [2x]



**Connecting metering pump**

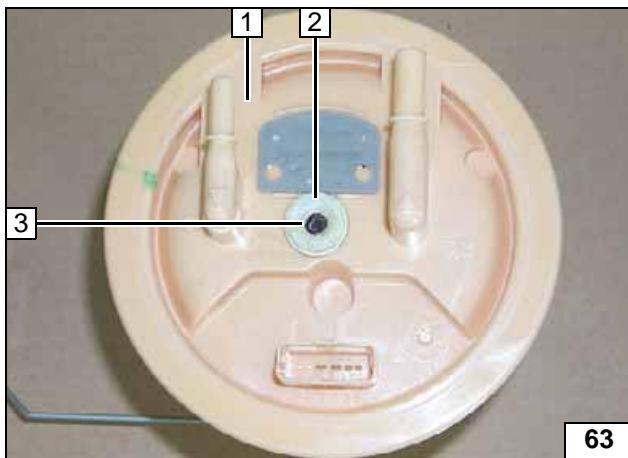

**Diesel**

Remove fuel-tank sending unit 1 in accordance with manufacturer's specifications.

- 1 Large diameter washer
- 3 Copy hole pattern, 6 mm dia. hole



**Removing fuel**

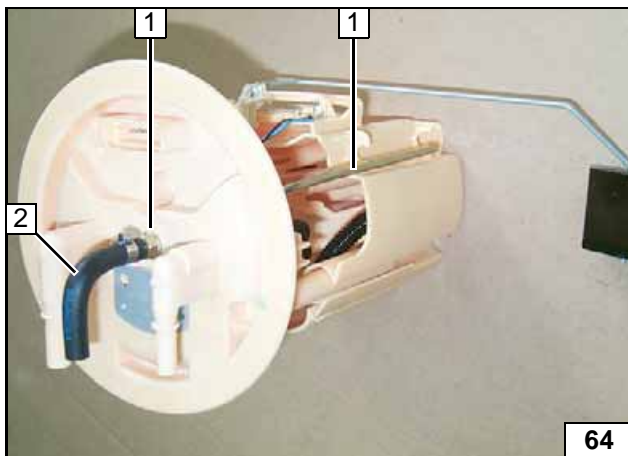

Shape fuel standpipe 1 according to template, cut to length and install. Moulded hose section of 3.5 mm dia on fuel tank standpipe.

- 2 3.5x4.5 dia moulded hose; 8 mm dia clamp



**Installing fuel standpipe**

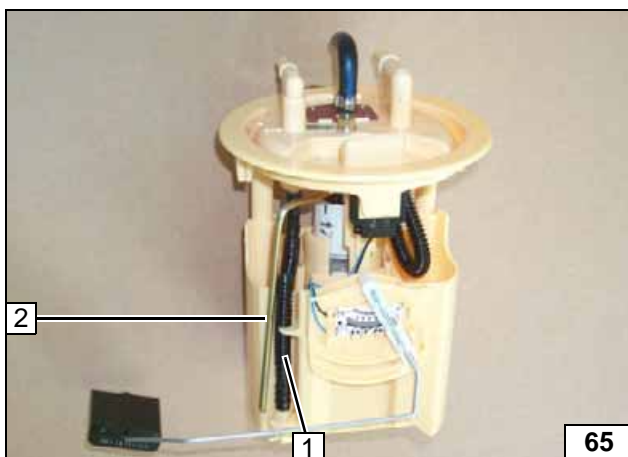
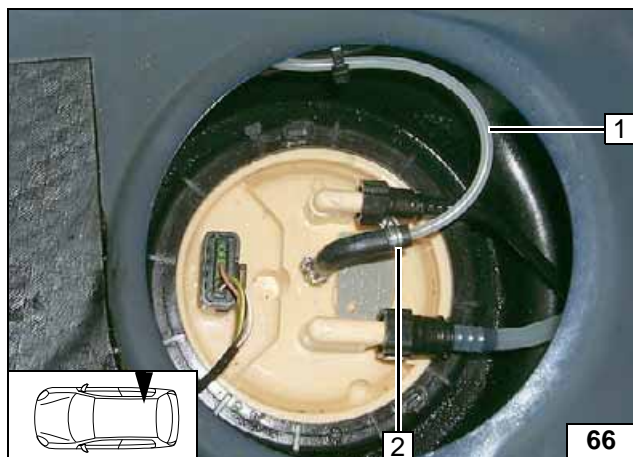
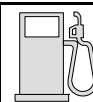

Figure shows fuel tank sending unit of HDI FAP!

Guide fuel tank sending unit 2 along the fuel return line 1.



**Installing fuel standpipe**



Install fuel-tank sending unit according to manufacturer's specifications. Replace sealing ring!

- 1 Fuel line
- 2 clamp of 10 mm dia



**Connect-  
ing fuel  
line**

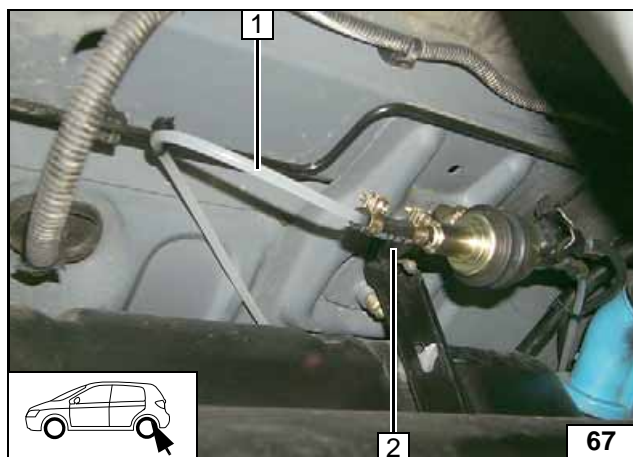

Check the position of the components; adjust if necessary. Check that they have free clearance.

- 1 Fuel line
- 2 Hose section, 10 mm dia. clamp [2x]



**Connect-  
ing meter-  
ing pump**

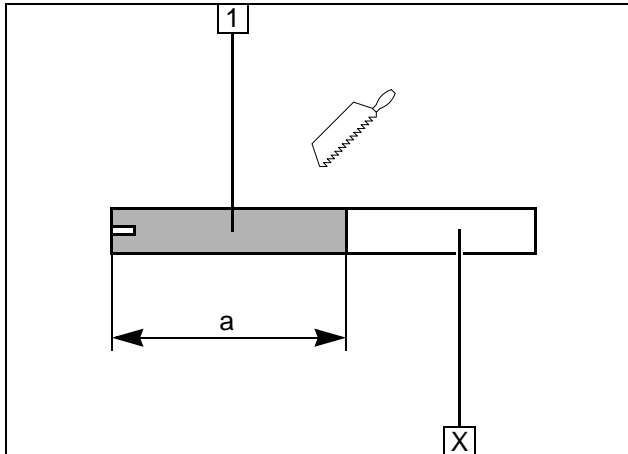
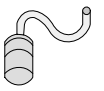

**Combustion air**

Discard section X.

- 1 Combustion air pipe  
a = 250



**Cutting combustion air pipe to length**

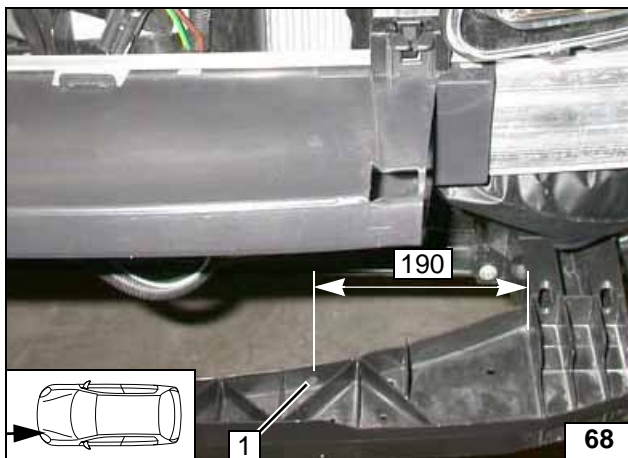

Drill hole in side member from rear at Position 1.

- 1 6.2 mm dia. hole (centered from bar)

**Hole for muffler**

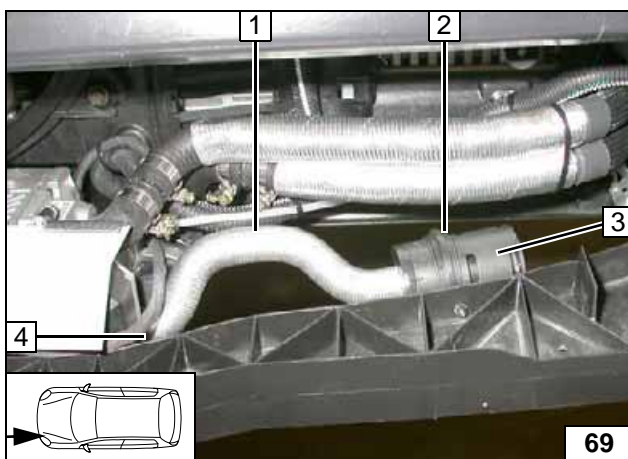

- 1 Combustion air pipe
- 2 Retaining clip in hole
- 3 Muffler
- 4 27 mm dia. clamp



**Installing muffler**

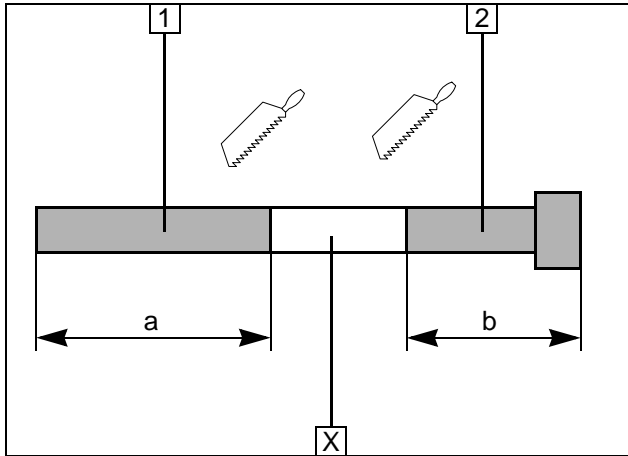
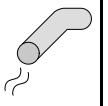

**Exhaust gas**

Discard section X

- 1 Exhaust pipe  
a = 120
- 2 Exhaust end section  
b = 110



**Preparing exhaust pipe**

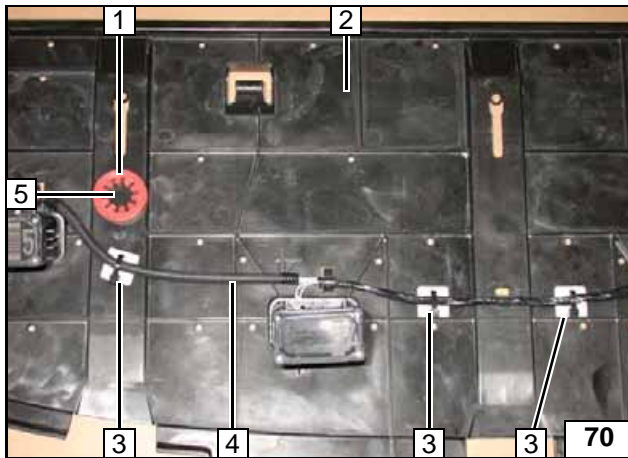

Route red (rt) rubber isolator 1 at Position 5. Paste base with cable tie 3 [3x]. Fasten original vehicle wiring harness 4.

- 2 Underride protection
- 5 Copy hole pattern, 44 mm dia. hole



**Cutting out underride protection**

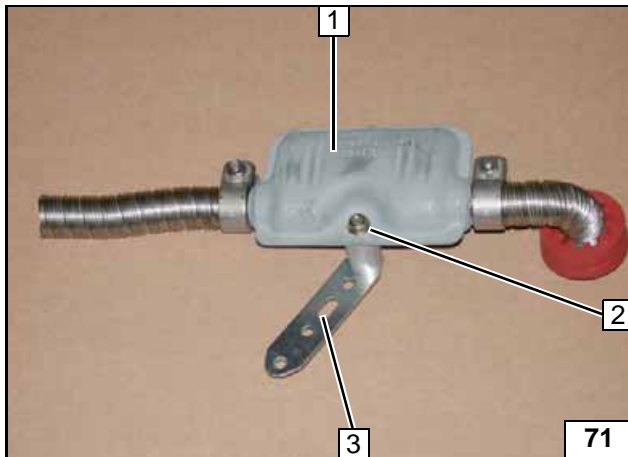

- 1 Muffer
- 2 M6x40 bolt, 30 mm shim, flanged nut
- 3 Perforated bracket

**Preassembling muffer**

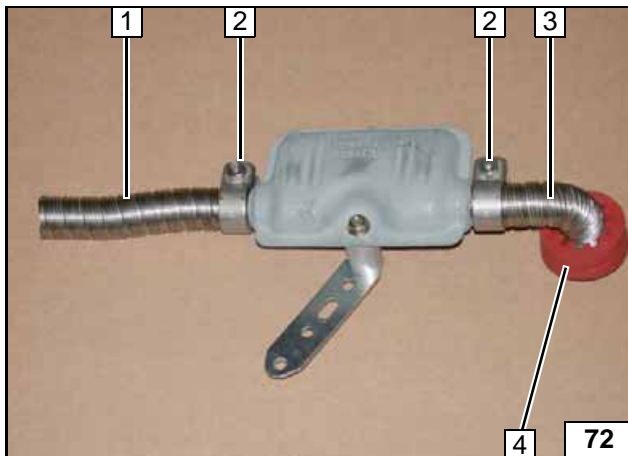

- 1 Exhaust pipe
- 2 Hose clamp [2x]
- 3 Exhaust end section
- 4 Red (rt) rubber isolator with groove

**Preassembling exhaust system**



Ensure sufficient distance to neighbouring components.

- 1 Hose clamp on exhaust manifold
- 2 M6x20 bolt, flanged nut



**Installing exhaust system**

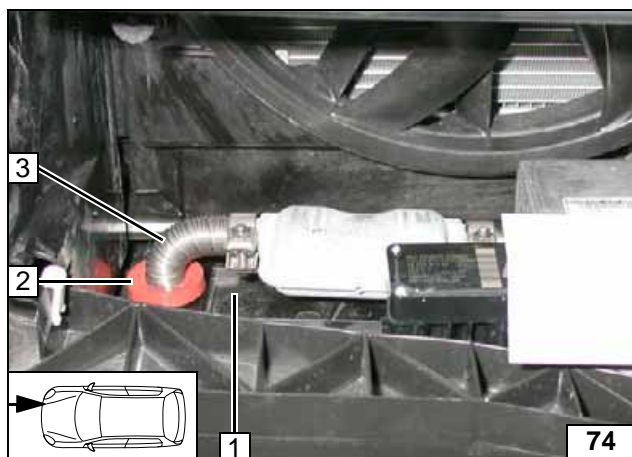

Install under-ride protection 1. Insert red rubber isolator 2 in under-ride protection 1. Align exhaust end section 3 flush on red rubber isolator 2.



**Mounting rubber isolator**

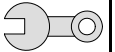

## Final Work

### WARNING!

Mount removed parts in reverse order.

Check all hoses, clamps and all electrical connections for firm seating.

Secure all loose cables using cable ties.

Only use manufacturer-approved coolant.

Spray heater components with anti-corrosion wax (Tectyl 100K, Order No. 111329).

- Connect the battery.
- Fill and bleed the coolant circuit according to the vehicle manufacturer's specifications.
- Set the digital timer.
- Make settings on A/C control panel according to the "Operating Instructions for End Customer".
- Check the proper operation of the parking heater, see the operating instructions/installation instructions.
- Attach instruction label "Switch off parking heater before refueling" in the area of the filling neck



Webasto AG  
Postfach 80  
D-82132 Stockdorf / Germany  
National Hotline: 01805 93 22 78  
(14 Cent aus dem deutschen Festnetz)  
Hotfax: 0395 5592 353  
Hotmail: [technikcenter@webasto.com](mailto:technikcenter@webasto.com)  
<http://www.webasto.de>



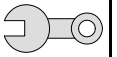

Gasoline fuel standpipe



100 mm

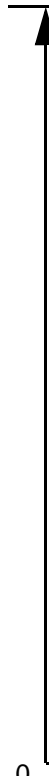

Scale 1:1

Compare the size of the printed version with dimension lines.  
Permitted tolerance a maximum of 2%.

Set the printer settings to "no margin" or "minimise margins"  
and 100% of the normal size.

100 mm

0

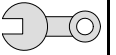

Diesel fuel standpipe

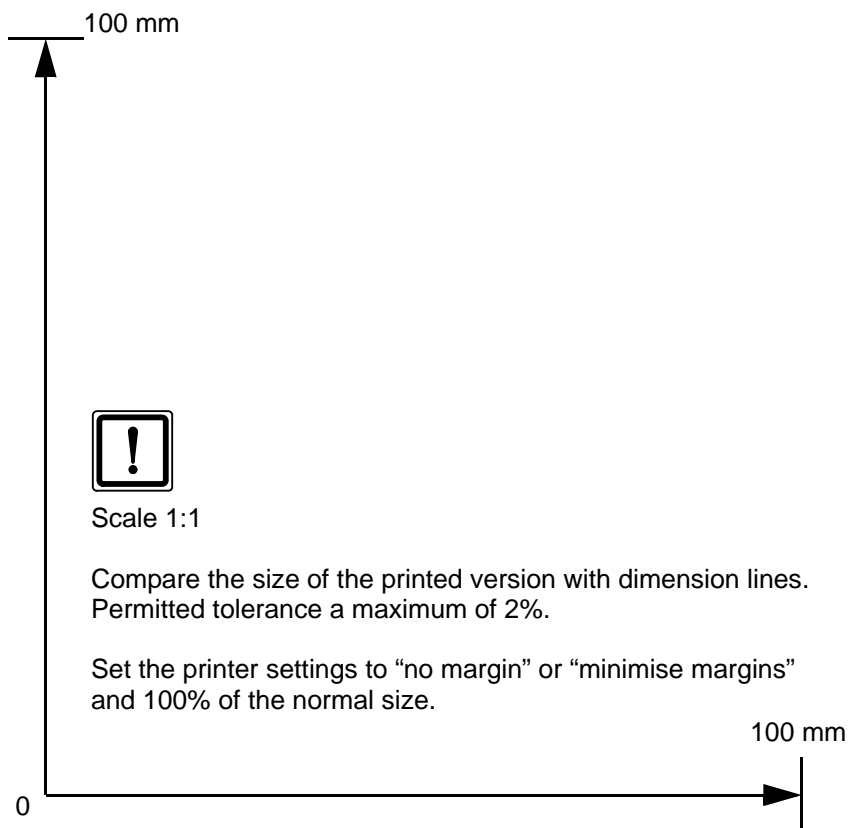
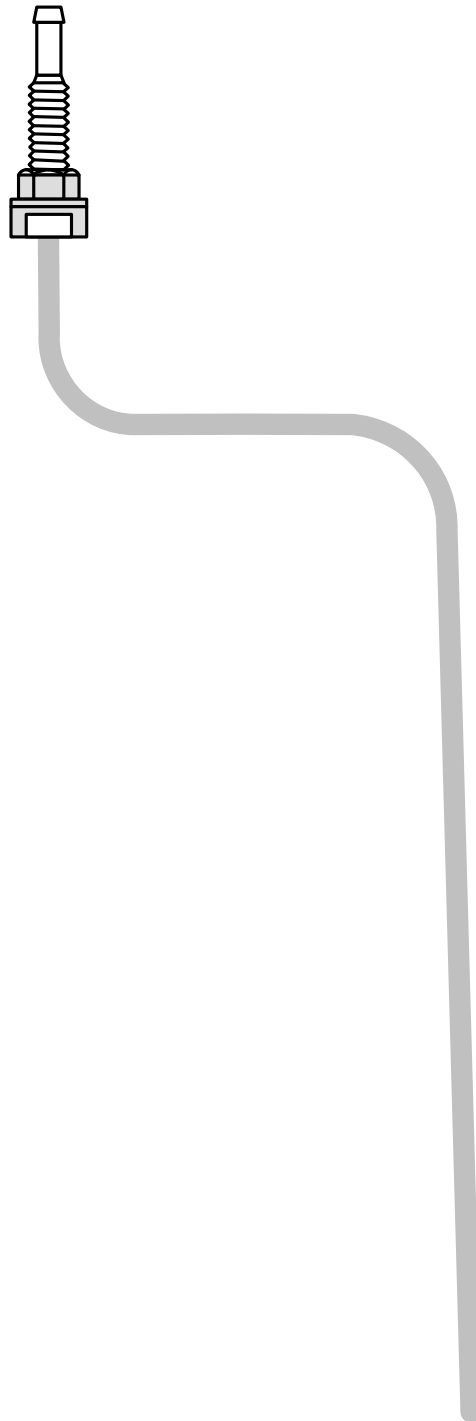

Scale 1:1

Compare the size of the printed version with dimension lines.  
Permitted tolerance a maximum of 2%.

Set the printer settings to "no margin" or "minimise margins"  
and 100% of the normal size.

**Operating Instructions for End Customer**



Please remove page and add to the vehicle operating instructions.

**Note:**

We recommend matching the heating time to the driving time.

Heating time = driving time

**Example:**

For a driving time of approx. 20 min. (in one direction), we recommend not exceeding a switch-on time of 20 min.

The passenger compartment monitoring must be disabled in vehicles with anti-theft alarm system. Deactivation instructions can be taken from the operating instructions of the vehicle!



If the summer/winter switch option has been installed, this must be switched in accordance with the time of year. The heater will then only switch on the vehicle fan to ventilate the vehicle interior in the position Winter heat and in the position Summer .

Before parking the vehicle, make the following settings:



- 1 Air outlet to windshield
- 2 Set fan to level "1", max. "2"
- 3 Set temperature to "max."

**Manual air conditioning**



- 1 Air outlet to windshield
- 2 Set temperature to "HI"

**Automatic air-conditioning**