

Water Heater

Thermo Top C Parking Heater  00 0002

Upgrade documentation

Citroen Jumpy / Fiat Scudo / Peugeot Expert

Diesel

From Model Year 2007

For left-hand drive vehicles only



WARNING!

Hazard warning:

The improper installation or repair of Webasto heating and cooling systems can cause fire or the leakage of deadly carbon monoxide, leading to serious injury or death.



To install and repair Webasto heating and cooling systems you need to have completed a special company training course and have the appropriate technical documentation, special tools and special equipment.

Only use genuine Webasto parts. See the Webasto air and water heaters accessories catalogue for this purpose.

NEVER attempt to install or repair Webasto heating or cooling systems if you have not successfully completed the company training and thereby acquired the required technical skills, or if you do not have access to the required technical documentation, tools and equipment needed to carry out correct installation and repairs.

ALWAYS follow all Webasto installation and repair instructions and observe all warnings.

The initial startup is to be executed with the Webasto Thermo Test Diagnosis.

Webasto does not accept any liability for defects and damage that are attributable to installation by untrained staff.

Citroen Jumpy / Fiat Scudo / Peugeot Expert

Table of Contents

Validity	2	Installing Relay Carrier	10
Upgrade Kit	3	Wiring Harness Routing	10
Foreword	3	Fan Controller for Manual Air-Conditioning	12
General Instructions	3	Fan Controller for Automatic Air-Conditioning	12
Special Tools	3	Wiring Harness Routing for All Vehicles	14
Explanatory Notes on Document	4	Connecting Heater	15
Preliminary Work	5	Final Work	16
Preparing Electrical System	6	Operating Instructions for End Customer	17
Electrical Connections	7		
Wiring Diagram for Manual Air-Conditioning	8		
Wiring Diagram for Automatic Air-Conditioning	9		

Validity

Manufacturer	Model	Type	EG-BE No. / ABE
Citroen	Jumpy	G9	e2 * 2001 / 116 * 0348 * ...
Citroen	Jumpy	G9	e2 * 2001 / 116 * 0350 * ...
Fiat	Scudo	270	e2 * 2001 / 116 * 0351 * ...
Peugeot	Expert	G9	e2 * 2001 / 116 * 0349 * ...

Engine type	Engine model	Output in kW	Displacement in cm ³
9HU	Diesel	66	1560
RHK	Diesel	88	1997
RHR	Diesel	100	1997
RHO	Diesel	120	1997

Vehicle and engine types, equipment variants and national specifications not listed in this installation documentation have not been tested. However, installation according to this upgrade documentation may be possible.

Upgrade Kit

Quantity	Description	Order No.:
1	Upgrade kit for Citroen Jumpy / Fiat Scudo / Peugeot Expert Diesel automatic air-conditioning	1313103E
1	Upgrade kit for Citroen Jumpy / Fiat Scudo / Peugeot Expert Diesel manual air-conditioning	1313104C

Foreword

This upgrade documentation applies to Citroen Jumpy / Fiat Scudo / Peugeot Expert Diesel vehicles - for validity, see page 2 - from model year 2007 and later, assuming technical modifications to the vehicle do not affect installation, any liability claims excluded.

Depending on the vehicle version and equipment, modifications may be necessary during installation with respect to these "upgrade instructions".

However, the stipulations in this "upgrade documentation", the "operating instructions" and "installation instructions" for the *Thermo Top C* must always be observed.

The corresponding rules of technology and any information from the vehicle manufacturer should be observed during the installation work.

General Instructions

Installation should be carried out according to the general, standard rules of technology. Unless specified otherwise, fasten hoses, lines and wiring harnesses to original vehicle lines and wiring harnesses using cable ties. Insulate loose wires and tie back. Connectors on electronic components have to audibly click into place during installation.

Sharp edges should be fitted with rub protection. Spray unfinished body areas, e.g. drilled holes, with anti-corrosion wax (Tectyl 100K, Order No. 111329).

When installing an IPCU, the corresponding settings must be checked or adjusted before the installation.

Special Tools

- 17 mm dia. sheet drill

Explanatory Notes on Document

You will find an identification mark on the outside top right corner of the page in question to provide you with a quick overview of the individual working steps.

Mechanical system

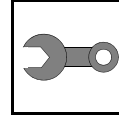

Electrical System

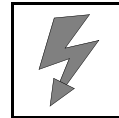

Coolant Circuit

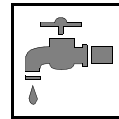

Fuel

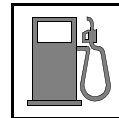

Exhaust gas

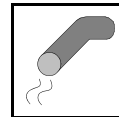

Combustion Air

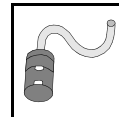

Special features are highlighted using the following symbols:



Specific risk of injury or fatal accidents.



Specific risk of damage to components.



Specific risk of fire or explosion.



Reference to general installation instructions of Webasto components or to the manufacturer's vehicle-specific documents.



Reference to a special technical feature.

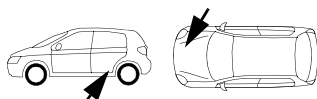

The arrow in the vehicle icon indicates the position on the vehicle and the viewing direction

All dimensions are in mm!

Tightening torque of hose clamps = 2.0 + 0.5 Nm!

Tightening torque of Ejet screws, Ejet studs = 10 Nm!

Preliminary Work

WARNING!

- Disconnect the battery.
- Remove the A-pillar trim in the footwell on the front passenger's side.
- Remove the fuse box from the battery compartment and unclip the retaining frame.
- Remove the glove compartment.
- Remove the horizontal air duct segment.
- Remove the A-pillar trim in the driver's side footwell.
- Remove the lower instrument panel trim on the driver's side.
- Remove the horizontal air duct segment.
- Remove the door sill cover on the driver's side.
- Detach the floor covering on the driver's side.

Please remove page 17 "Operating Instructions for End Customer" and add to the operating instructions.



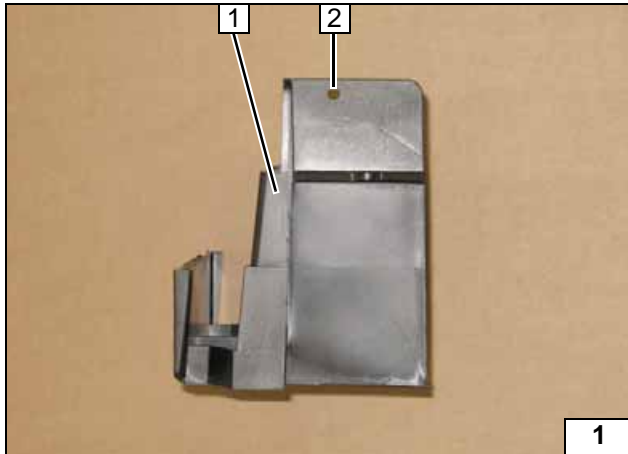

Preparing Electrical System

- 1 Retaining frame of fuse box
- 2 4.5 mm dia. hole

Hole of retaining frame

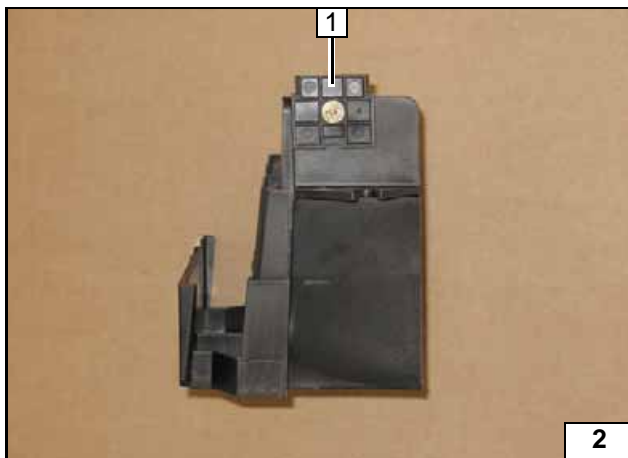

- 1 Retaining plate of fuse holder, M4x10 countersunk head screw, self-locking nut

Installing retaining plate of fuse holder

Only with automatic air-conditioning

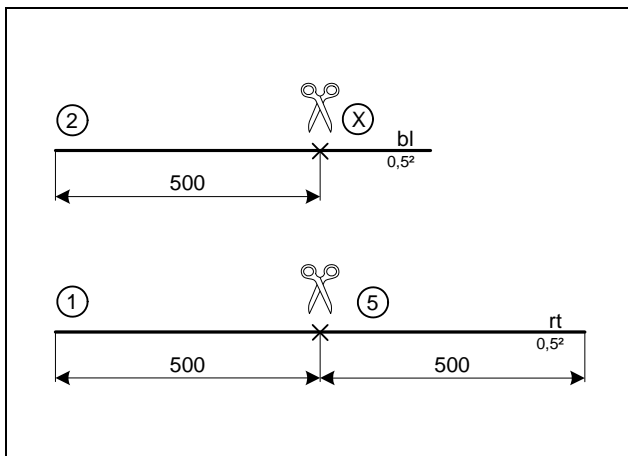

Cutting wires to length

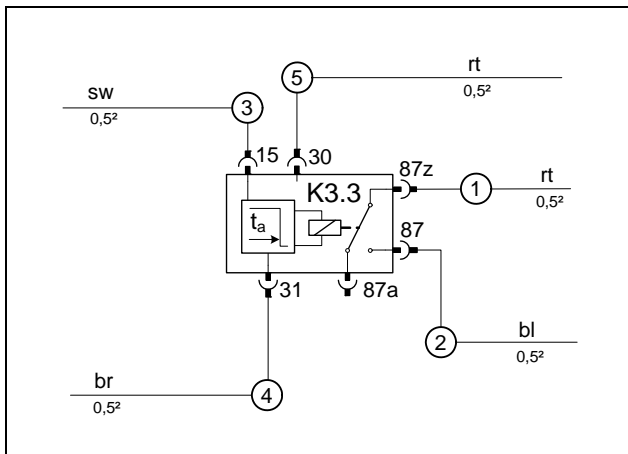

Produce connections as shown in wiring diagram. Pull wire ③ and ④ into protective sleeving.



Preparing K3.3 relay



Electrical Connections

Relay carrier

- 1 Relay carrier (figure shows version for manual air-conditioning!)

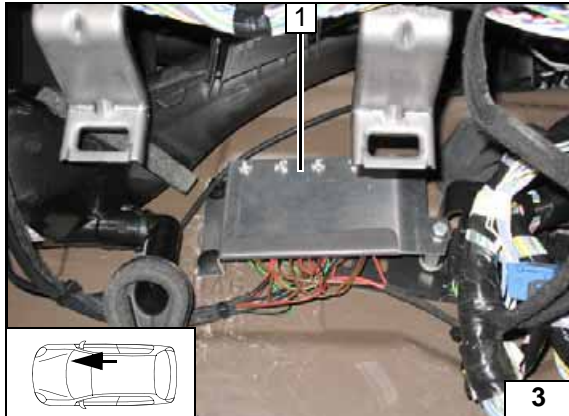

Fuse holder

- 1 Fuse holder

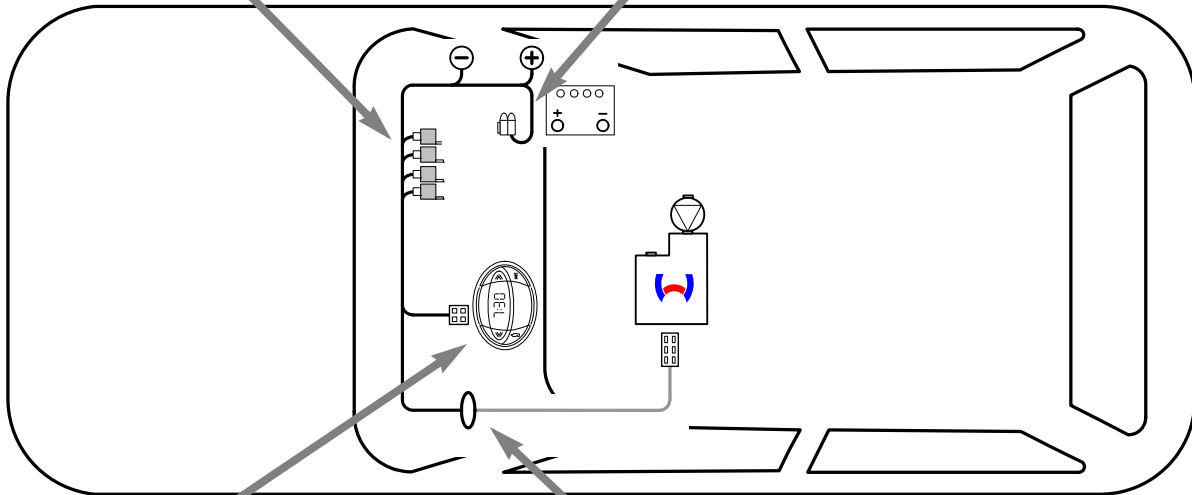
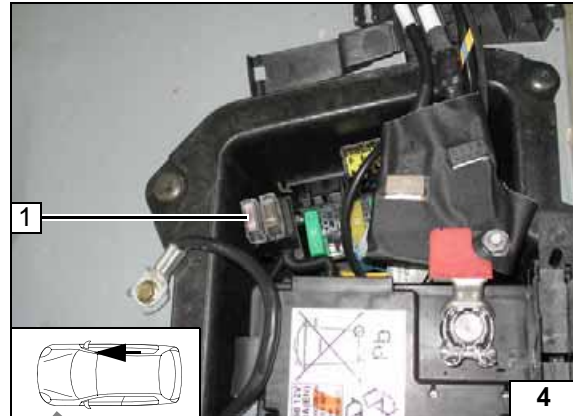

Wiring harness routing diagram



Digital Timer

If there are function errors in the digital timer at temperatures below 5°C, route the brown (br) wire of pin 4 from the digital timer (see wiring diagram*) directly to the earth.

- 1 Digital timer

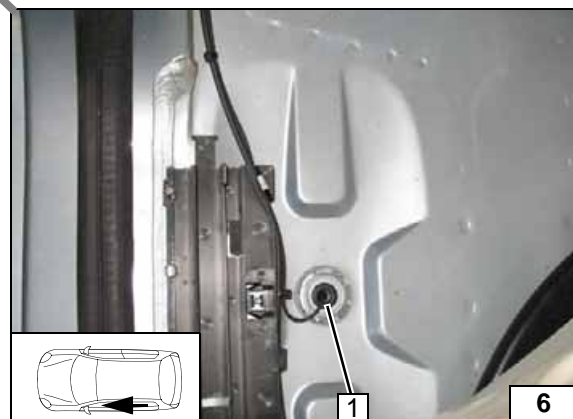

Wiring harness pass through

- 1 Protective rubber plug



Wiring Diagram for Manual Air-Conditioning

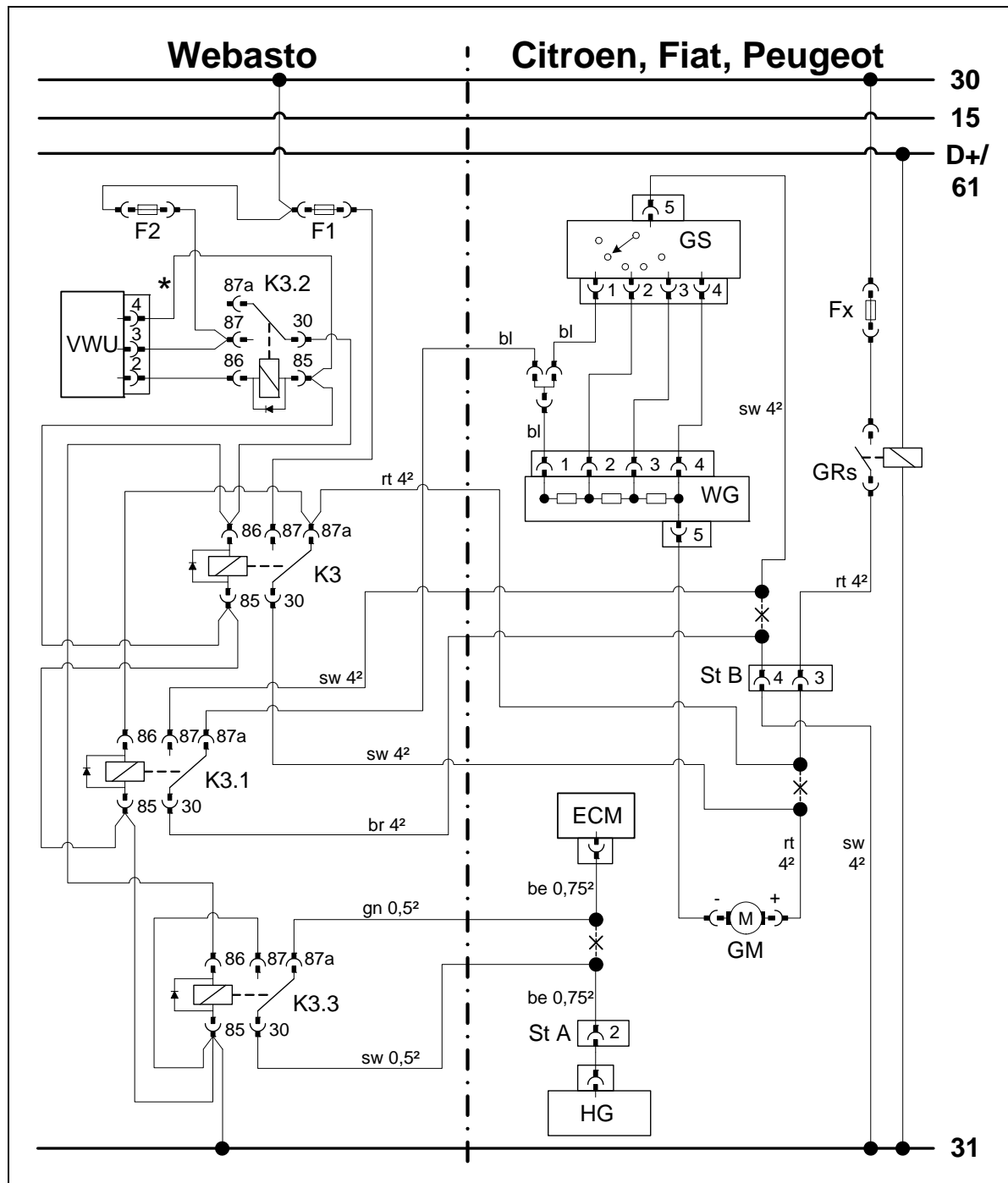

Wiring diagram

Webasto components		Vehicle components		Colours and symbols	
F1	25A fuse	HG	Heater TT-Z/C	rt	red
F2	3A fuse	GM	Fan motor	be	beige
K3	Fan relay	WG	Resistor group	sw	black
K3.1	Additional relay 1	ECM	Engine control unit	br	brown
K3.2	Additional relay 2	GS	Fan switch	gn	green
K3.3	Additional relay 3	GRs	Fan relay	bl	blue
VWU	Digital Timer	Fx	Fan fuse	be	beige
		St A	6-pin connector of heater adapter wiring harness	*	See comment on Page 7.
		ST B	Adapter	X	Cutting point
				Wiring colours may vary.	

Legend



Wiring Diagram for Automatic Air-Conditioning

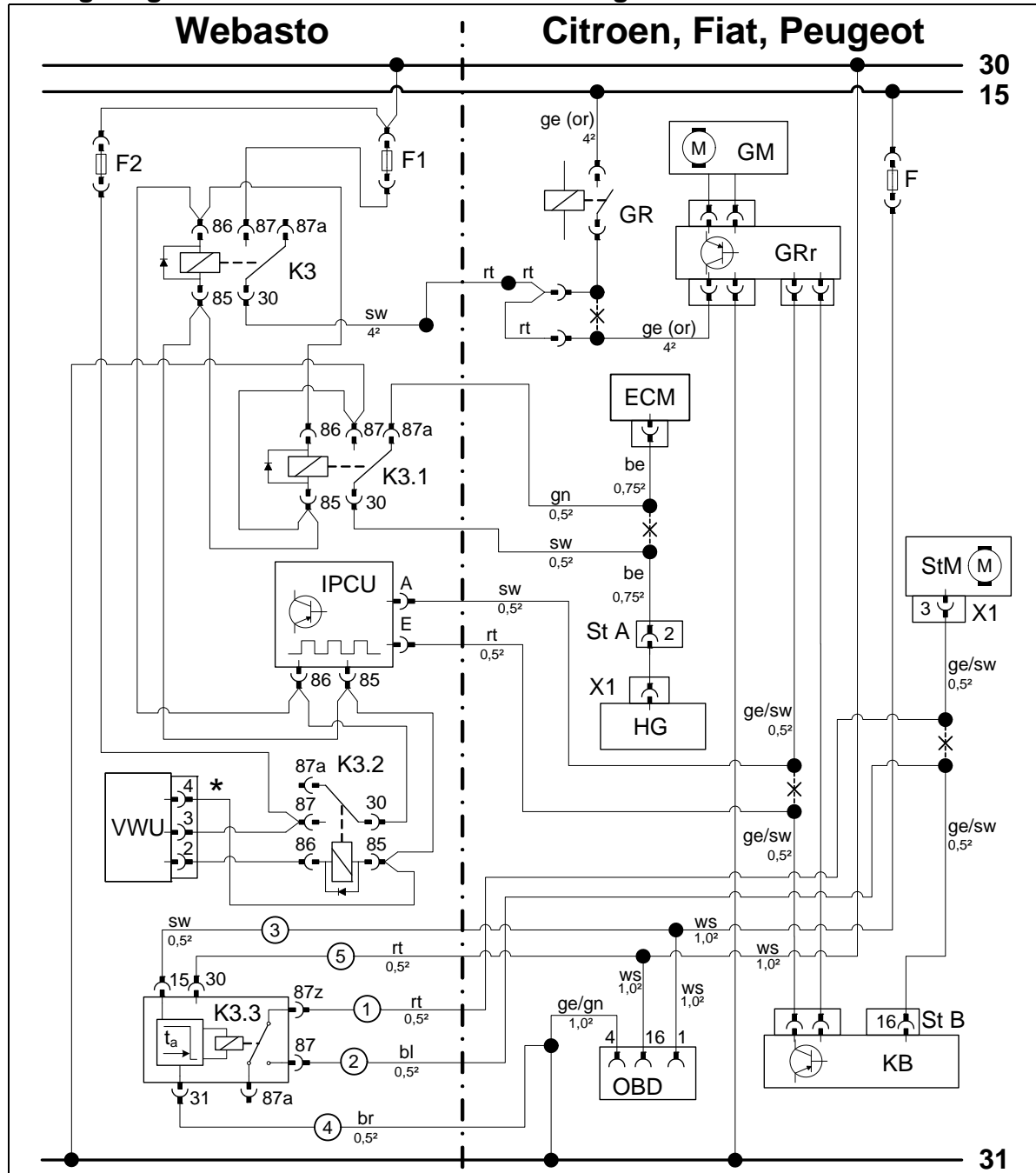

Wiring diagram

Webasto components		Vehicle components		Colours and symbols	
F1	25A fuse	HG	Heater TT-Z/C	rt	red
F2	3A fuse	X1	6-pin heater connector	be	beige
K3	Fan relay	GRr	Fan controller	sw	black
K3.1	Additional relay 1	GM	Fan motor	br	brown
K3.2	Additional relay 2	ECM	Engine control unit	gn	green
K3.3	Additional relay 3	KB	A/C control panel	ge	yellow
VWU	Digital Timer	St A	6-pin connector of heater adapter wiring harness	or	orange
IPCU	Pulse width modulator	St B	12-pin connector KB	ws	white
IPCU adjustment values:		OBD	Diagnosis connector OBD	*	See comment on Page 7.
Duty cycle: 42%		F	Fuse	X	Cutting point
Frequency: 1200Hz		StM	Positioning motor of air distribution		
Voltage: 4.6V		X1	6-pin connector of StM		
Function: High-Side					Wiring colours may vary.

Legend

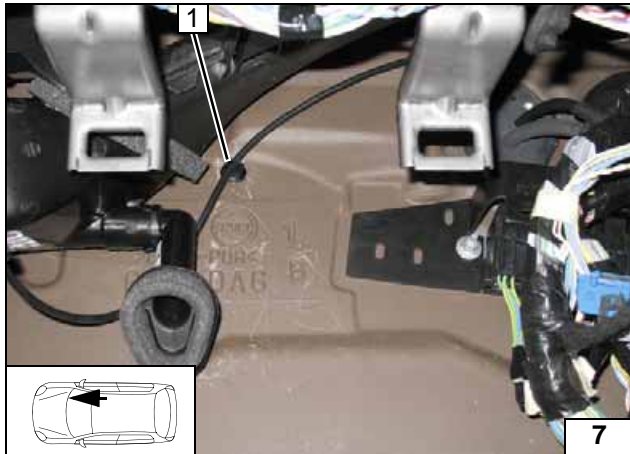

Installing Relay Carrier

- 1 Detach cable bracket



Preparing installation location

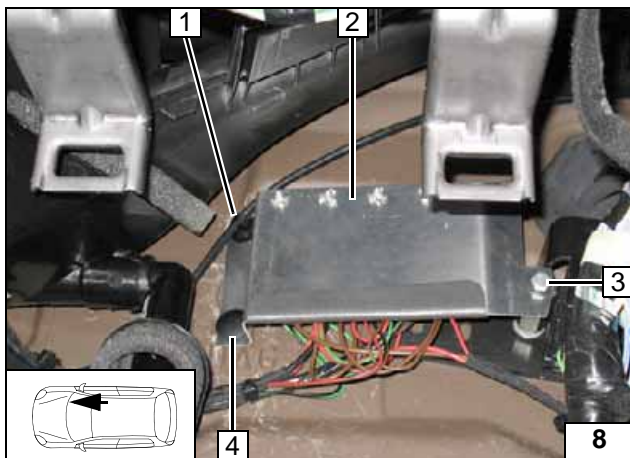

Align relay carrier 2 and fasten. Copy hole pattern with punching tip at position 4 onto insulation mat and press in plastic dowel.

- 1 Cable bracket mounted
- 2 30 mm spacer nut, M6x12 bolt, spring lockwasher



Installing relay carrier

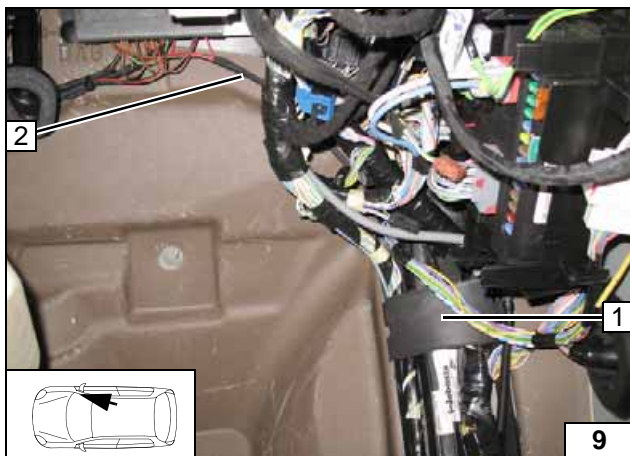

Wiring Harness Routing

- 1 Cable duct of A-pillar
- 2 Wiring harness

Routing wiring harness on A-pillar

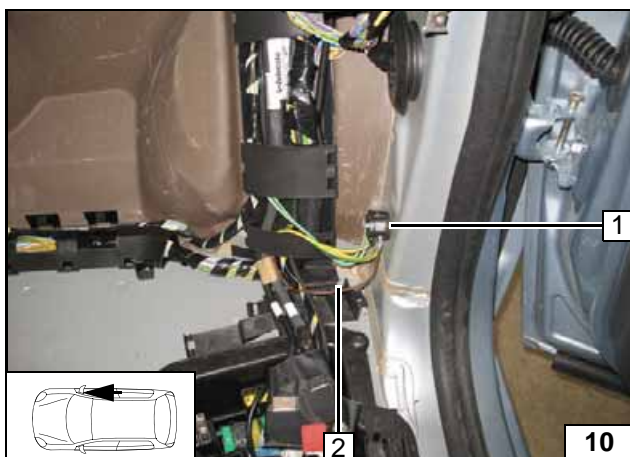

- 1 Earth point
- 2 Brown (br) earth wire of wiring harness

Connection of earth wire

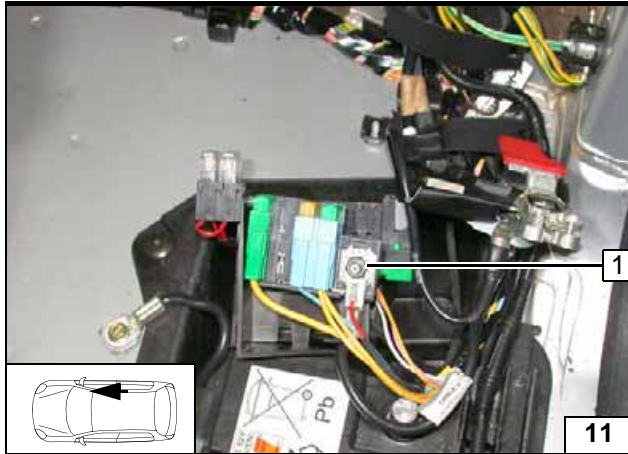

1 Positive connection

Conne-
ction of pos-
itive wire

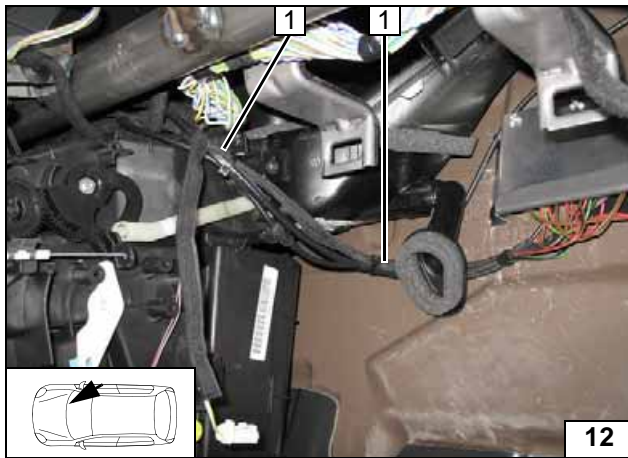

Route wiring harness 1 along original vehicle lines via A/C module to driver's side.



Routing
lines

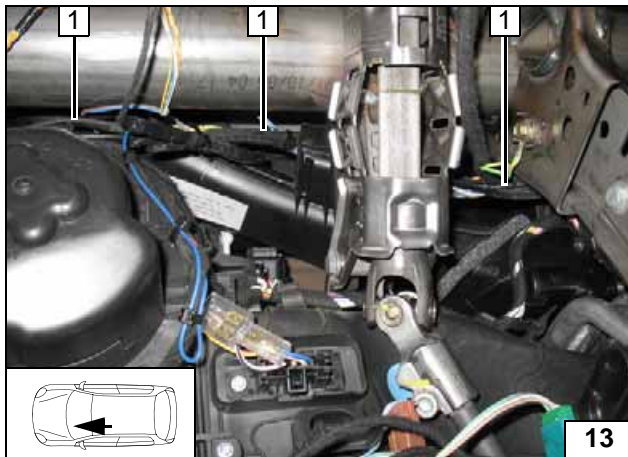

1 Wiring harness

Routing
lines to fan
motor

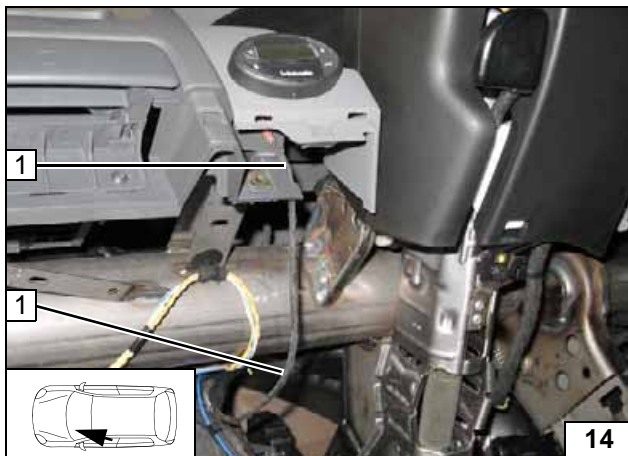

1 Wiring harness of digital timer

Routing
wiring har-
ness

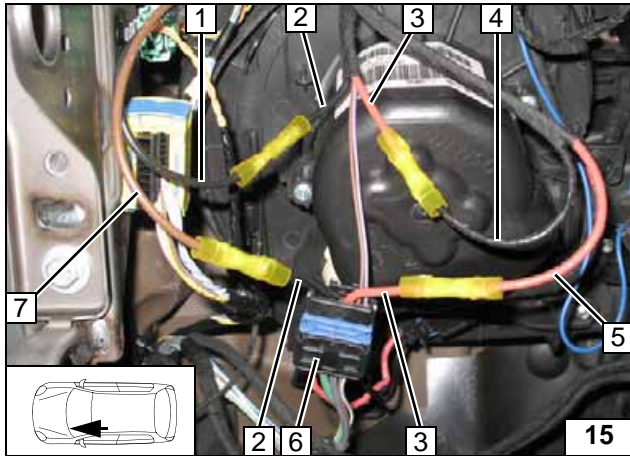

Fan Controller for Manual Air-Conditioning

Connection to 6-pin intermediate connector 6 before the fan motor. Produce connections as shown in wiring diagram.

- 1 Black (sw) wire from K3.1/87
- 2 Black (sw) wire of connector, pin 4, disconnected
- 3 Red (rt) wire of connector, pin 3, disconnected
- 4 Black (sw) wire from K3/30
- 5 Red (rt) wire from K3/87a
- 7 Brown (br) wire from K3.1/30



Connecting intermediate connector

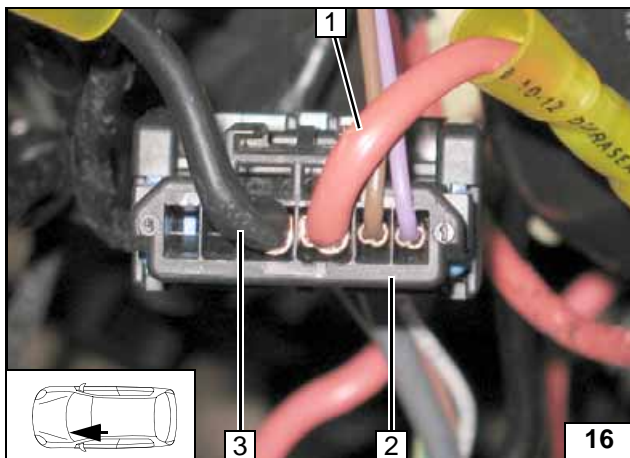

View of intermediate connector 2 from wire side.

- 1 Red (rt) wire of connector, pin 3
- 3 Black (sw) wire of connector, pin 4



Adapter view

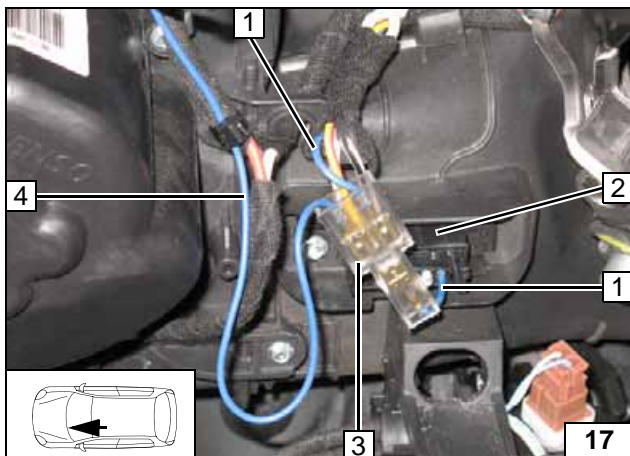

Connection to 5-pin connector 2 from resistor group. Produce connections as shown in wiring diagram.

- 1 Blue (bl) wire of connector, pin 1, disconnected
- 3 3x connector
- 4 Blue (bl) wire from K3.1/87a



Connecting resistor group

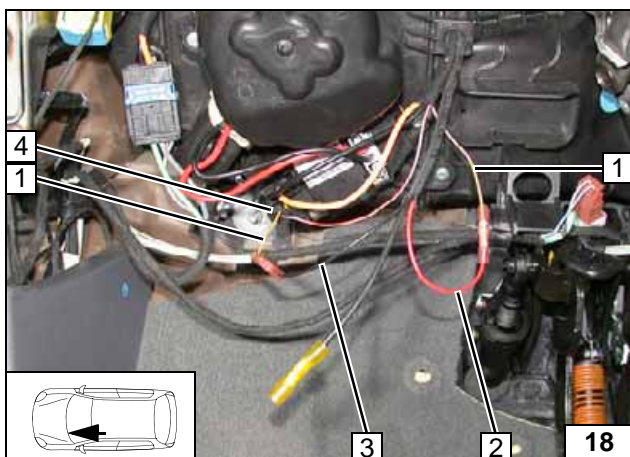

Fan Controller for Automatic Air-Conditioning

Connection on 2-pin connector 4 from fan controller. Produce connections as shown in wiring diagram.

- 1 Yellow/black (ge/sw) wire separated
- 2 Red (rt) wire on IPCU input
- 3 Black (sw) wire of IPCU output



Connecting fan controller

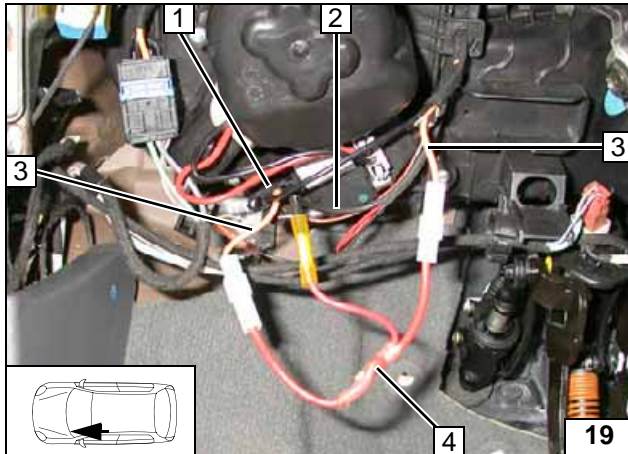
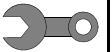

Connection on 2-pin connector 1 from fan controller. Produce connections as shown in wiring diagram.

- 2 Black (sw) wire from K3/30
- 3 Yellow (orange) (ge/or) wire separated
- 4 Adapter cable



**Connect-
ing fan
controller**

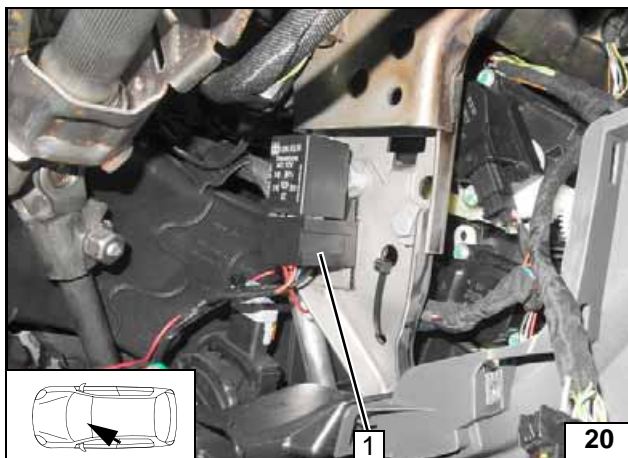

Fasten socket of K3.3 relay 1 with double-sided adhesive tape.



**Installing
K3.3 relay**

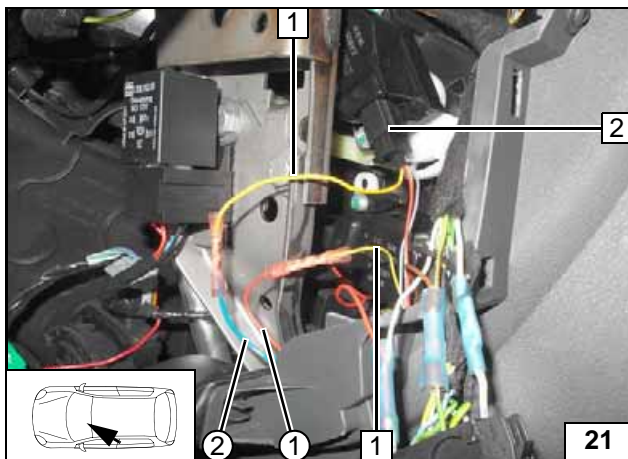

Connection to 6-pin connector X1 2 pin 3 from air distribution positioning motor.

- 1 Yellow/black (ge/sw) wire separated
- ① Red (rt) wire from K3.3/87z
- ② Blue (bl) wire of K3.3/87



**Conne-
ction to po-
sitioning
motor**

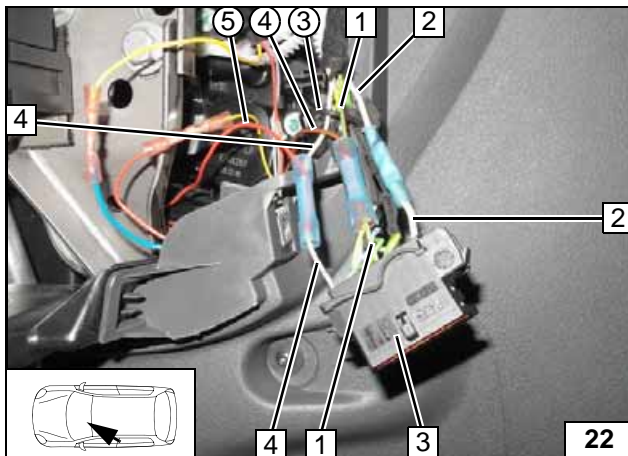

Connection to OBD socket outlet 3. Produce connections as shown in wiring diagram.

- 1 Green/yellow (gn/ge) wire of 4-pin, separated
- 2 White (ws) wire, Pin 1, separated
- 4 White (ws) wire, Pin 16, separated
- ③ Black (sw) wire from K3.3/15
- ④ Brown (br) wire from K3.3/31
- ⑤ Red (rt) wire from K3.3/30



**Conne-
ction to
OBD sock-
et outlet**

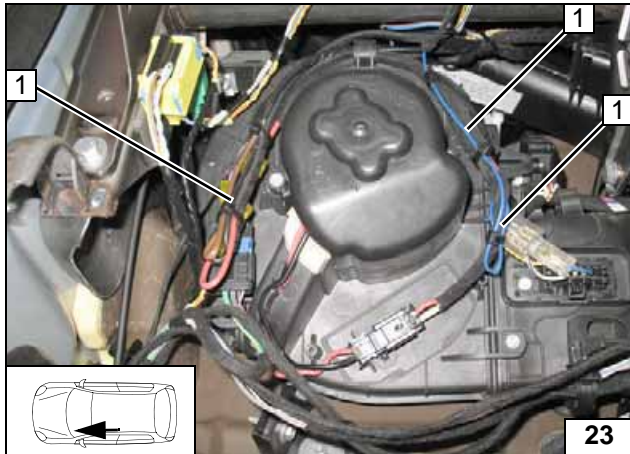

Wiring Harness Routing for All Vehicles

- 1 Wiring harness installed using cable ties. (Image shows fan connection for manual air-conditioning)

Installing wiring harnesses

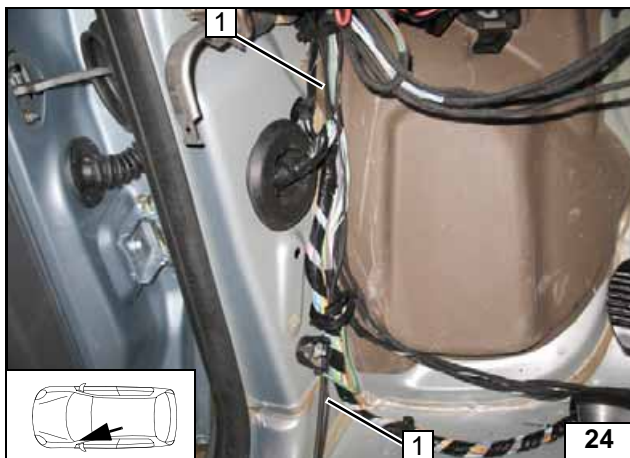

Route wiring harness 1 along original vehicle lines on A-pillar



Routing lines to underbody

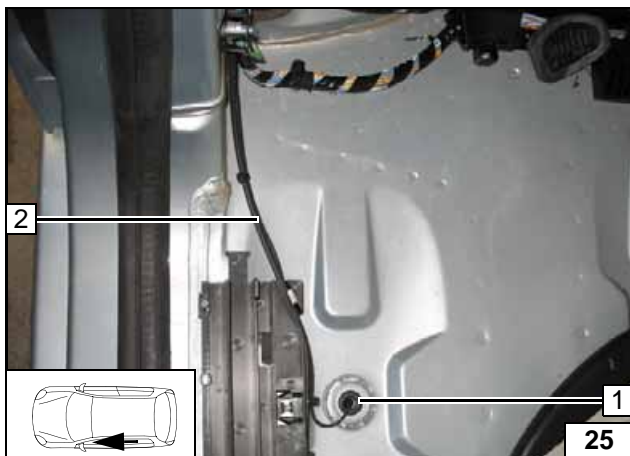

- 1 Sealing plug, 17 mm dia. hole, protective rubber plug
- 2 Wiring harness of heater

Wiring harness pass through



- 1 Wiring harness of heater

Routing line

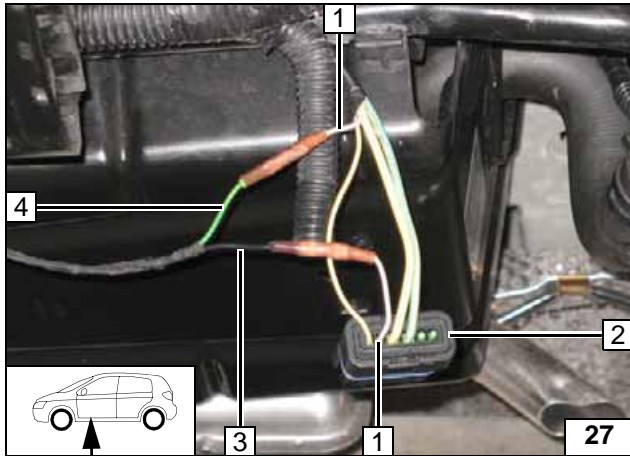

Connecting Heater

Connection to 6-pin connector **2** from adapter wiring harness. Produce connections as shown in wiring diagram.

- 1 Beige (be) wire, pin 2, separated
- 3 Black (sw) wire from connector
- 4 Green (gn) wire from wiring harness



**Connect-
ing heater**

Fasten connector **2** and wiring harness **1**.

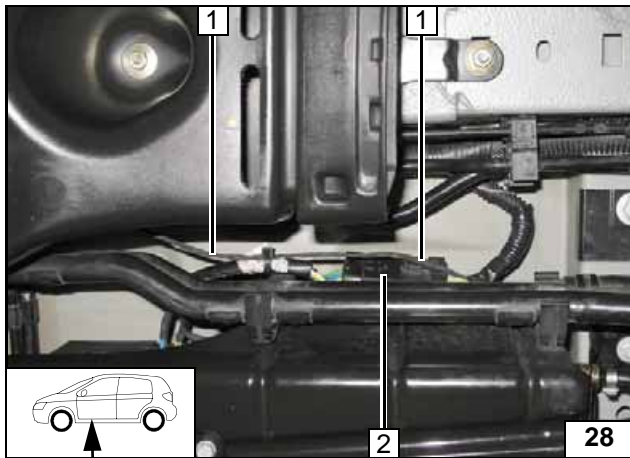

**Routing
wiring har-
ness**

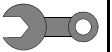

Final Work

WARNING!

Mount removed parts in reverse order. Check all hoses, clamps and all electrical connections for firm seating. Insulate all loose wires and tie back.

Spray the heater components with anti-corrosion wax (Tectyl 100K, Order No. 111329).

- **Connect the battery.**
- **Adjust digital timer, teach telestart transmitter.**
- **Make settings on A/C control panel according to the "Operating Instructions for End Customer".**
- **Place the "Switch off parking heater before refuelling" signboard in the area of the filler neck.**
- **For initial startup and function check, please see installation instructions.**



Operating Instructions for End Customer



Please remove page and add to the vehicle operating instructions.

Note:

We recommend matching the heating time to the driving time.

Heating time = driving time

Example:

For a driving time of approx. 20 min. (in one direction), we recommend not exceeding a switch-on time of 20 min.

Passenger compartment monitoring, if installed, must be deactivated in addition to the vehicle settings for the heating operation .



For instructions on deactivation, please refer to the operating instructions of the vehicle.

Before parking the vehicle, make the following settings:



- 1 Air outlet onto windscreen
- 2 Set fan to level "1", or possibly "2"
- 3 Set temperature to "max."

Manual air-conditioning



- 1 Set temperature on right and left to "HI"
- 2 Air outlet faces upward

Automatic air-conditioning

