

# Water Heater



**Thermo Top E Parking Heater**

  
00 0003

**Thermo Top C Parking Heater**

  
00 0002

**Thermo Top P Parking Heater**

  
00 0104

## Installation documentation

### Fiat Bravo

1.6l D Multijet 88kW  
from Model Year 2007  
Left-hand drive vehicle



#### **WARNING!**

Hazard warning:

Incorrect installation or repair of Webasto heating systems may cause a fire or result in the emission of carbon monoxide, which can be fatal. Serious or fatal injuries can be caused as a result.



Specialist company training, technical documentation, specialised tools and equipment are required to install and repair Webasto heating and cooling systems. Only original Webasto parts must be used. For this, also see the catalog of air and water heater accessories from Webasto.

**NEVER attempt to install or repair Webasto heating or cooling systems if you have not successfully completed the company training and thereby acquired the required technical skills, or if you do not have access to the required technical documentation, tools and equipment needed to carry out correct installation and repairs.**

ALWAYS follow all Webasto installation and repair instructions and observe all warnings.

Webasto does not accept any liability for defects and damage that are attributable to installation by untrained staff.

**Table of contents**

Heater / installation kit	3	Preparing installation location	12
Foreword	3	Installing heater	13
General instructions	3	Exhaust gas	14
Special tool	3	Coolant circulation	15
Explanatory notes on document	4	Fuel	19
Preliminary work	5	Combustion air	22
Heater installation location	5	Final Work	23
Preparing electrical system	6	Template for Bracket	24
Electrical system	7	Template for Perforated Fastening Strap	25
Fan controller for manual air conditioning	8	Operating Instructions for End Customer	26
Automatic air-conditioning fan controller	9		
Telestart option	11		

**Validity**

Manufacturer	Model	Type	EG-BE No./ ABE
Fiat	Bravo	198	e3 * 2001/116 * 0248

Engine type	Engine model	Output in kW	Displacement in cm <sup>3</sup>
192A2000	Diesel	88	1598

Vehicle and engine types, equipment variants and national specifications not listed in this installation documentation have not been tested. However, installation according to this installation documentation may be possible.

The installation location of a digital timer and summer/winter switch should be confirmed with the end customer before installation.

## Heater / installation kit

Quantity	Description	Order No.:
1	Retail accessories <i>Thermo Top E / C / P</i>	See price list
1	Installation Kit for Fiat Bravo1.6l D Multijet 88kW	1314103B
1	Heater control	See price list

### Heater recommended for the respective vehicle class:

Vehicle	Heater
Compact car	Thermo Top E
Mid-size car, station wagon	Thermo Top C
Full-size car, van, offroader	Thermo Top P

The selection of the heater is based on the passenger compartment size of the vehicle and the level of comfort required by the customer!



### Foreword

This installation documentation applies to the Fiat Bravo 1.6l D Multijet 88kW vehicles - for validity, see page 2 - from model year 2007 and later, assuming technical modifications to the vehicle do not affect installation, any liability claims excluded. Depending on the vehicle version and equipment, modifications may be necessary during installation with respect to this installation documentation.

However, the stipulations in the "installation documentation" and "operating and maintenance instructions" for the *Thermo Top C/P/E* must always be observed.

The corresponding rules of technology and any information from the vehicle manufacturer should be observed during the installation work.

### General instructions

Installation should be carried out according to the general, standard rules of technology. Unless specified otherwise, fasten hoses, lines and wiring harnesses to original vehicle lines and wiring harnesses using cable ties.

Sharp edges should be fitted with edge protectors (split-open plastic hose).

Spray unfinished body areas, e.g. drilled holes, with anti-corrosion wax (Tectyl 100K, Order No. 111329).

### Special tool

- Torque wrench for 2.0 - 10 Nm
- Hose clamping pliers
- Metric thread-setter kit

**Explanatory notes on document**

To provide you with a quick overview of the individual working steps, you will find an identification mark on the outside top right corner of the page in question.

**Mechanical system**

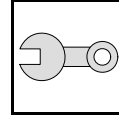

**Electrical system**

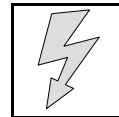

**Coolant circuit**

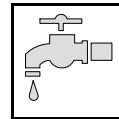

**Fuel**

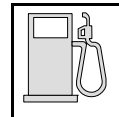

**Exhaust gas**

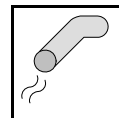

**Combustion air**

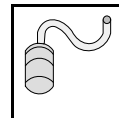

**Special features are highlighted using the following symbols:**



Specific risk of injury or fatal accidents.



Specific risk of damage to components.



Specific risk of fire or explosion.



Reference to general installation instructions of Webasto components or to the manufacturer's vehicle-specific documents.



Reference to a special technical feature.

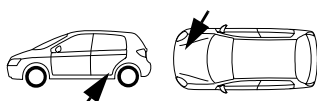

The arrow in the vehicle icon indicates the position on the vehicle and the viewing angle.

**All dimensions are in mm!**

**Tightening torque of hose clamps = 2.0 + 0.5 Nm!**

**Tightening torque of Ejet screws, Ejet studs = 10 Nm!**

## Preliminary work

### WARNING!

- Open the fuel tank cap, ventilate the tank.
- Close the tank cap again.
- Remove the battery.
- Depressurize the cooling system.
- Copy the factory number from the original type label to the duplicate type label.
- Remove years that do not apply from the duplicate label.
- Attach the duplicate label (type label) in the appropriate place.
- Detach the central electrical box in the engine compartment on the left.
- Remove the engine design cover.
- Remove the left wheel well trim.
- Remove the underride protection.
- Remove the cover of the fuel lines on the underbody.
- Remove the cover on the right next to the fuel tank.
- Fold up the seat surface of the rear bench seat.
- Open the tank-fitting service lid.
- Remove the fuel-tank sending unit in accordance with the manufacturers specifications.
- Remove the cover of the central electrical box on the driver's side.
- Remove the A/C control panel; only with automatic air-conditioning.

Remove page 26 "Operating Instructions for End Customer" and add to the vehicle operating instructions.

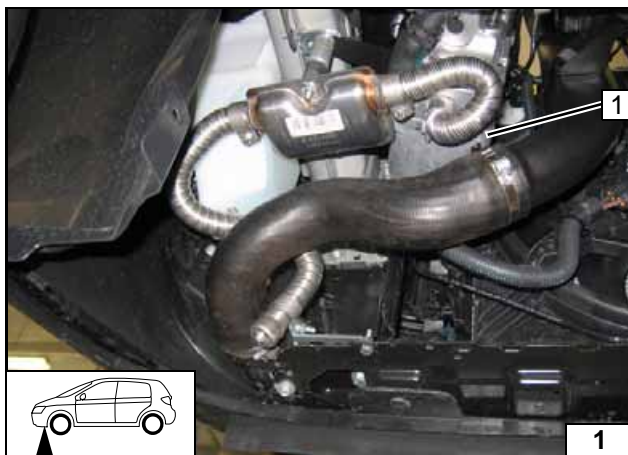

### Heater installation location

1 Heater

Installation location

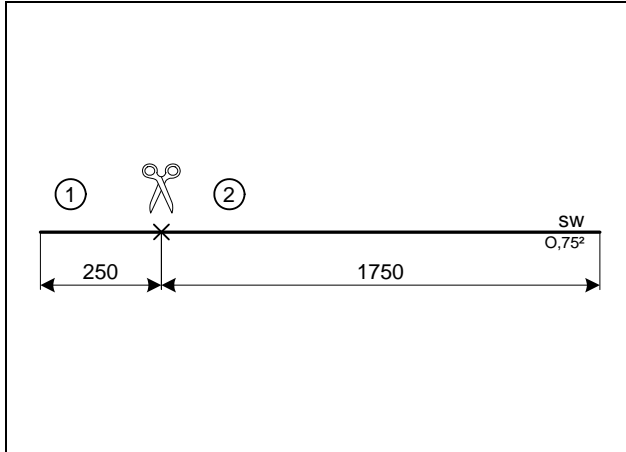

**Preparing electrical system**

Only with automatic air-conditioning



**Cutting wires to length**

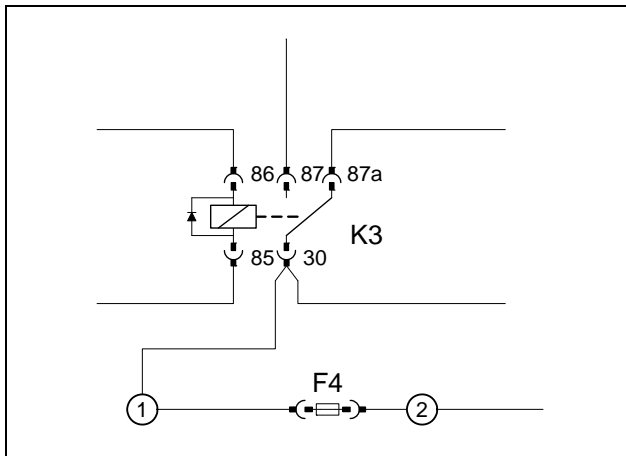

Produce connections as shown in wiring diagram. Install wire section 2 in the protective sleeving provided.



**Preparing fuse F4**



**Electrical system**

**Fuse holder, relay K3**

- 1 Fuse holder
- 2 Angle bracket, drilled out to 8 mm dia.
- 3 Original vehicle stud bolt, flanged nut
- 4 Relay K3, M5x16 bolt, washer, flanged nut

**Summer / winter switch option**

- 1 Summer/winter switch, drilled hole 12 mm dia.

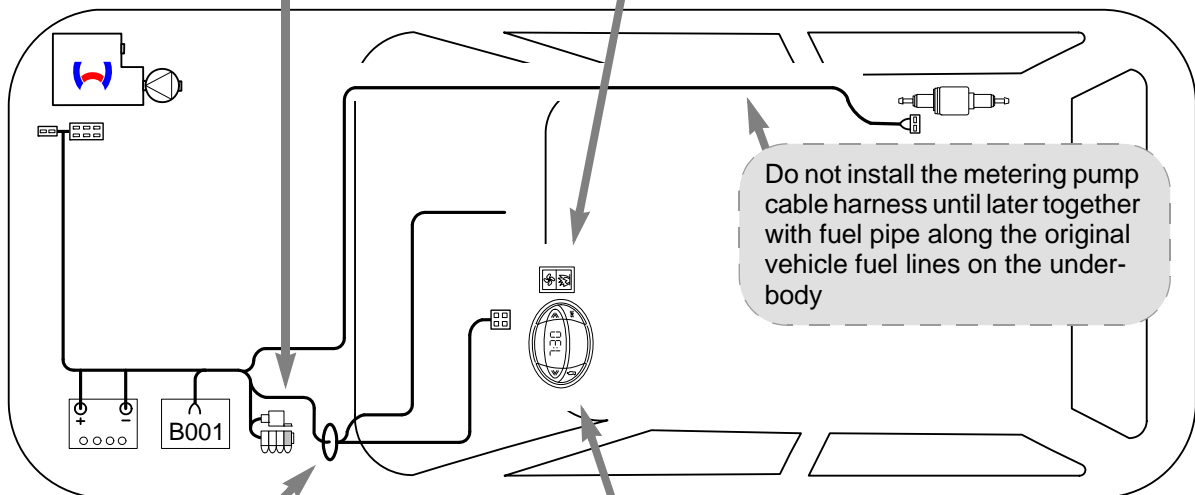
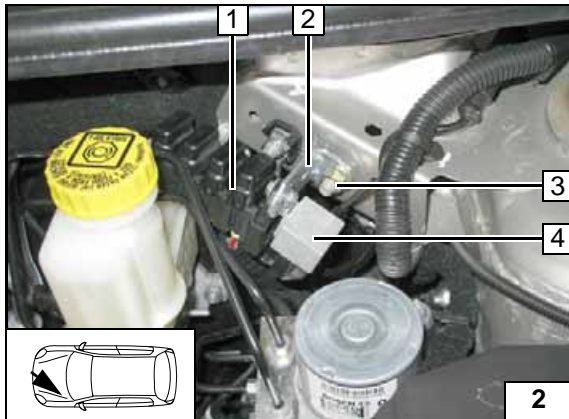

**Wiring harness installation diagram**

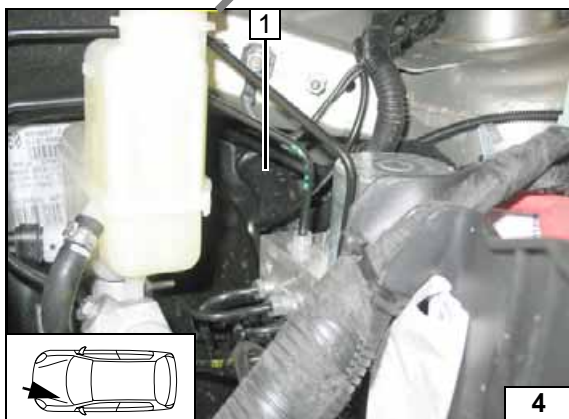

**Wiring harness pass through**

- 1 Protective rubber plug

**Digital timer**

- 1 Digital timer



Fan controller for manual air conditioning

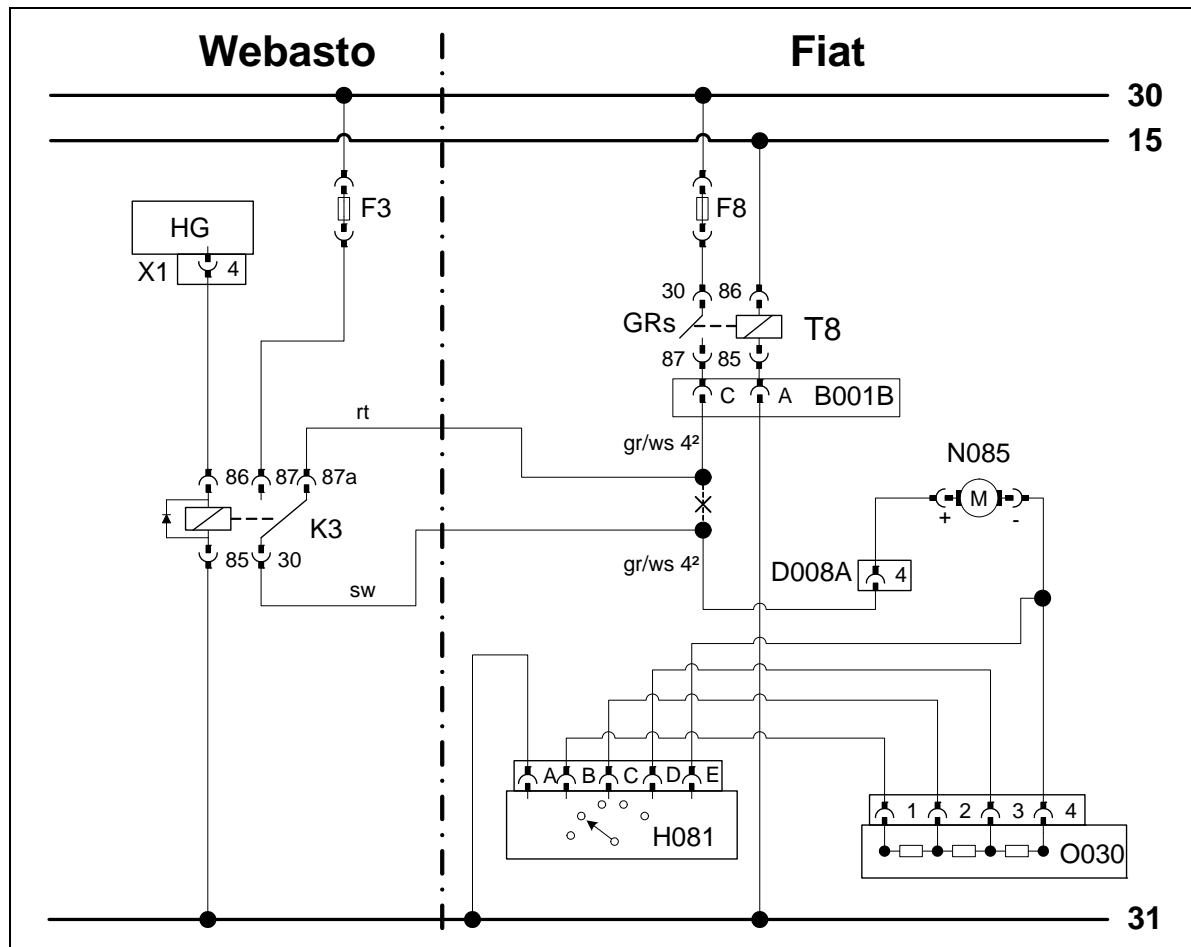

Wiring diagram

Webasto components		Vehicle components		Colours and symbols	
HG	Heater TT-E/C/P	N085	Fan motor	rt	red
X1	6-pin heater connector	GRs	Fan relay T8	ws	white
F3	Fuse 25A	H081	Fan switch	sw	black
K3	Fan relay	O030	Resistor group	br	brown
		F8	Fuse	gn	green
		B001B	Connector central electrical box, gray	gr	gray
				X	Cutting point
				Wiring colours may vary.	

Legends

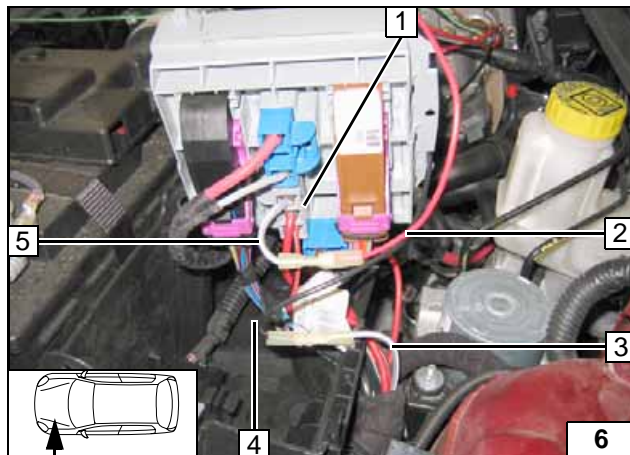

Connection on gray (gr) 3-pin connector B001B 1 of central electrical box.  
Produce connections as shown in wiring diagram.

- 2 Red (rt) wire from K3/87a
- 3 Gray/white (gr/ws) wire of fan motor
- 4 Black (sw) wire from K3/30
- 5 Gray/white (gr/ws) wire of connector



Connecting fan-motor





Automatic air-conditioning fan controller



Wiring diagram

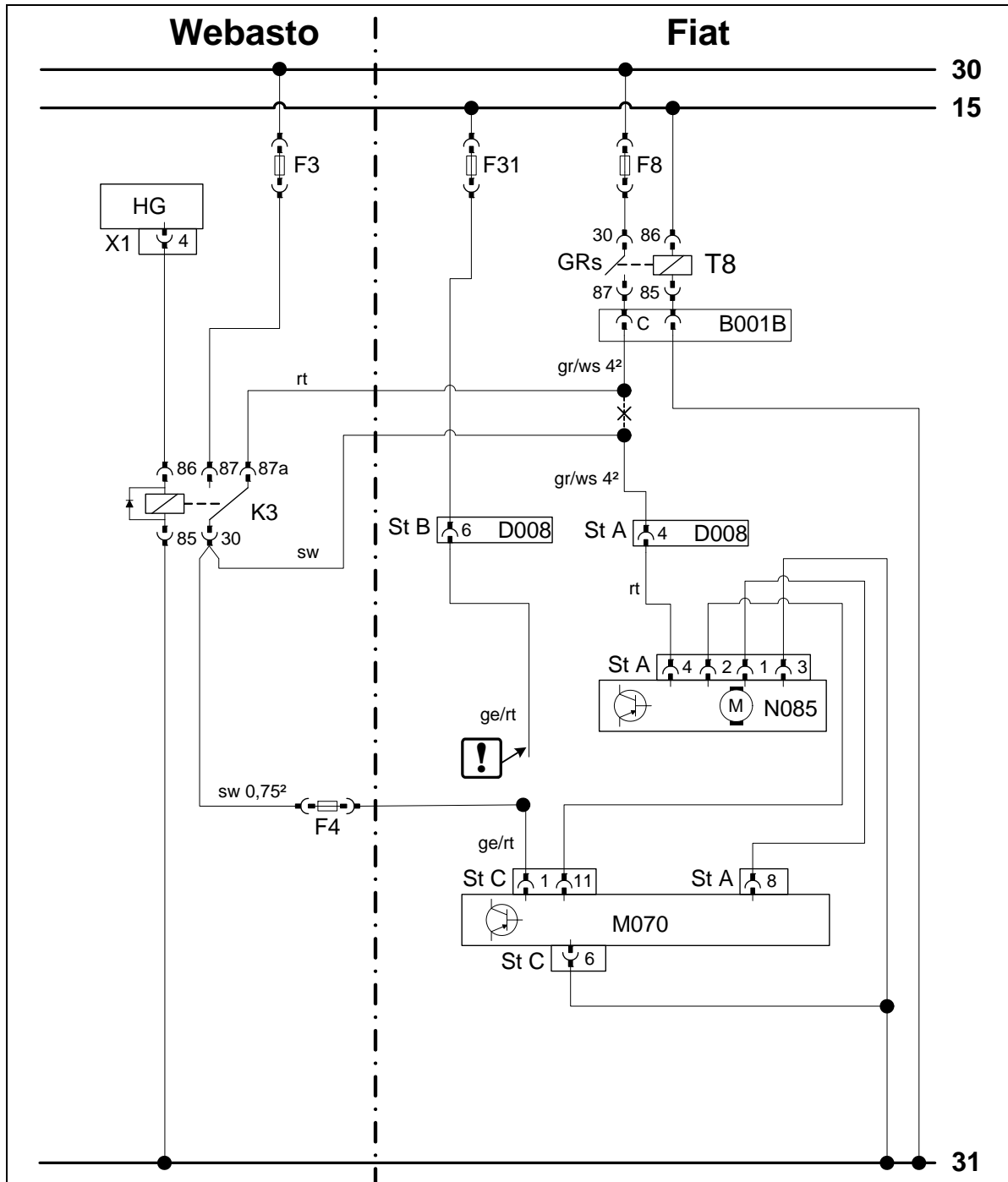

Webasto components		Vehicle components		Colours and symbols	
HG	Heater TT-E/C/P	N085	Fan unit	rt	red
X1	6-pin heater connector	GRs	Fan relay T8	ws	white
F3	Fuse 25A	M070	Air-conditioning control panel	sw	black
K3	Fan relay	St C	Connector, blue, 12-pin	br	brown
F4	Fuse 5A	B001B	Connector of central electrical box, gray	gn	green
		F8	Fuse 30A	ge	yellow
		F31	Fuse 5A	gr	gray
		D008A	Connector	!	Insulate wire ends and tie back
				X	Cutting point
					Wiring colours may vary.

Legends

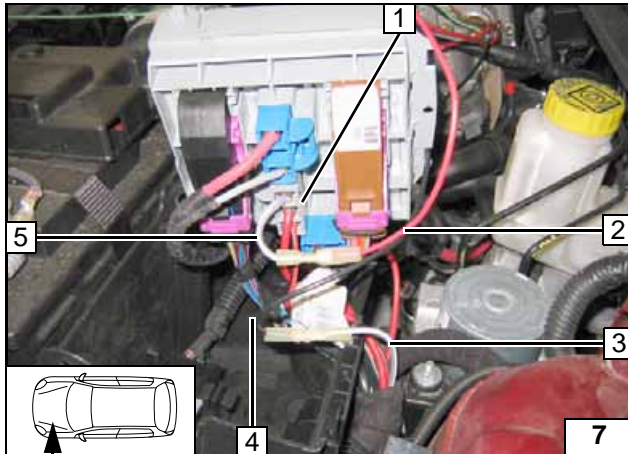
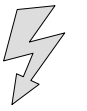

Connection on gray (gr) 3-pin connector B001B 1 of central electrical box.  
Produce connections as shown in wiring diagram.

- 2 Red (rt) wire from K3/87a
- 3 Gray/white (gr/ws) wire of fan motor
- 4 Black (sw) wire from K3/30
- 5 Gray/white (gr/ws) wire of connector



**Connect-  
ing fan-mo-  
tor**

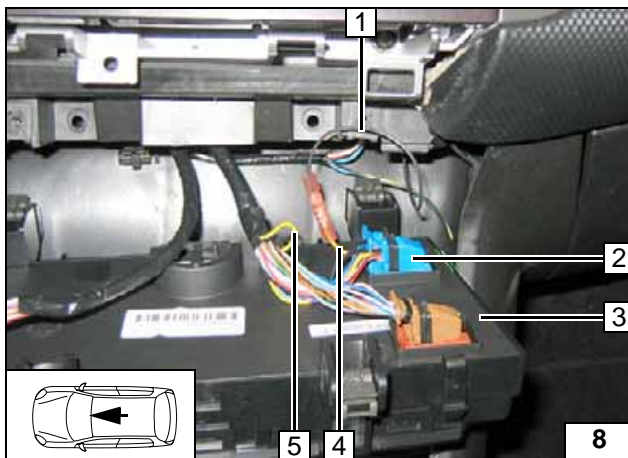

Connection on 12-pin connector 2 from A/C control panel 3.  
Produce connections as shown in wiring diagram.

- 1 Black (sw) wire of K3/30, fuse F4
- 4 Yellow/red (ge/rt) connector
- 5 Yellow/red (ge/rt) wire of fuse F31



**Connect-  
ing A/C  
control  
panel**

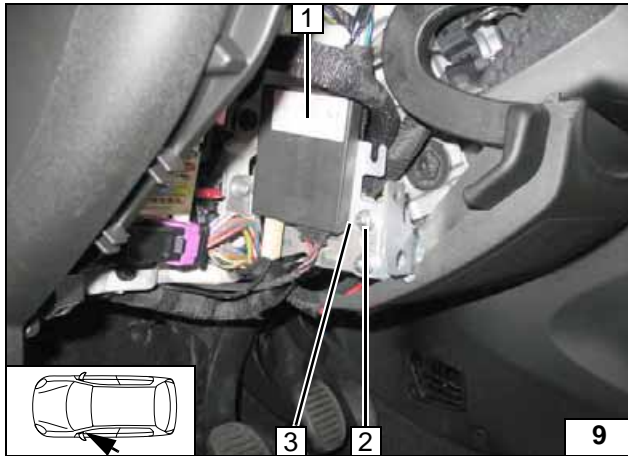

**Telestart option**

- 1 Receiver
- 2 Original vehicle stud bolt, original vehicle flanged nut
- 3 Bracket, hole drilled out to 6.5 mm dia.



**Installing receiver**

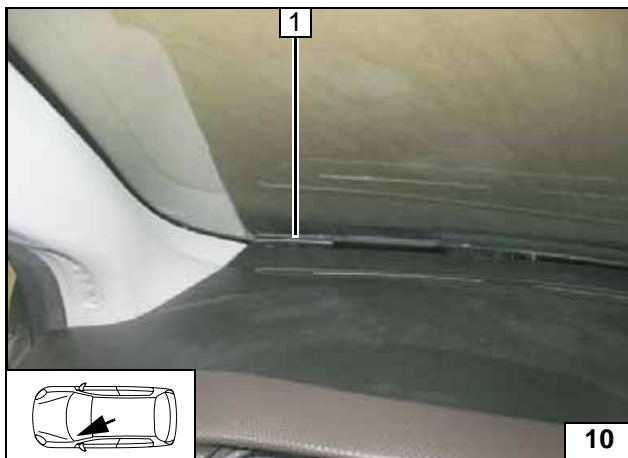

- 1 Antenna

**Installing antenna**

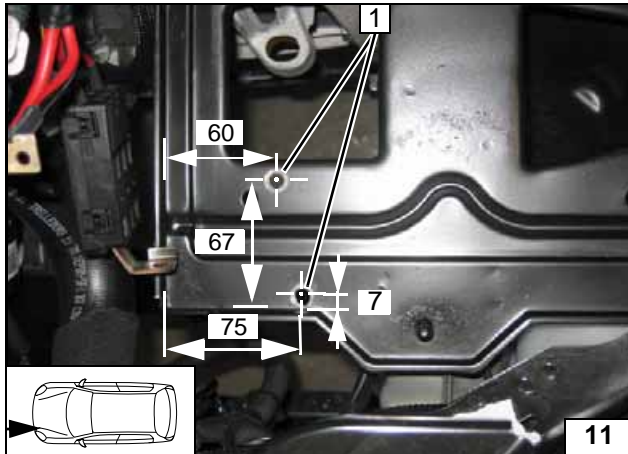
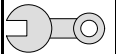

**Preparing installation location**

Countersink holes 1 6.5 mm dia. [2x].



**Copying hole pattern**

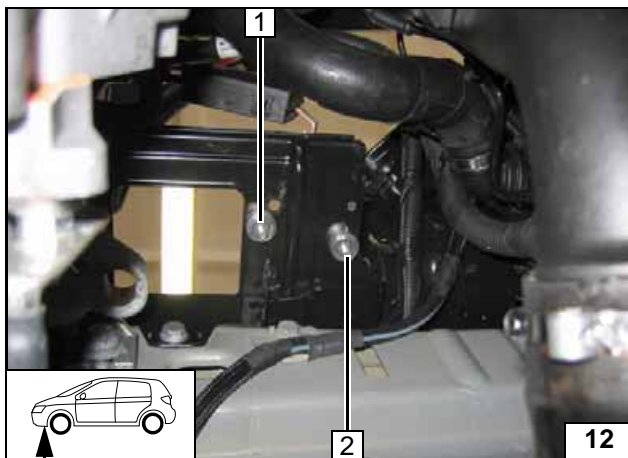

- 1 M6x30 countersunk head screw, 10 mm shim, pin lock
- 2 M6x30 countersunk head screw, 10 mm shim, large diameter washer, pin lock

**Installing counter-sunk head screw**

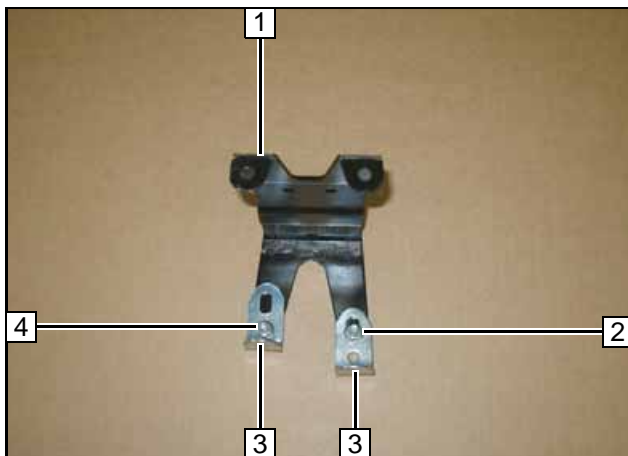

Bend bracket 1 according to template.

- 2 M6x20 bolt, flanged nut
- 3 Angle bracket [2x]
- 4 M6x12 bolt, flanged nut



**Preassembling bracket**

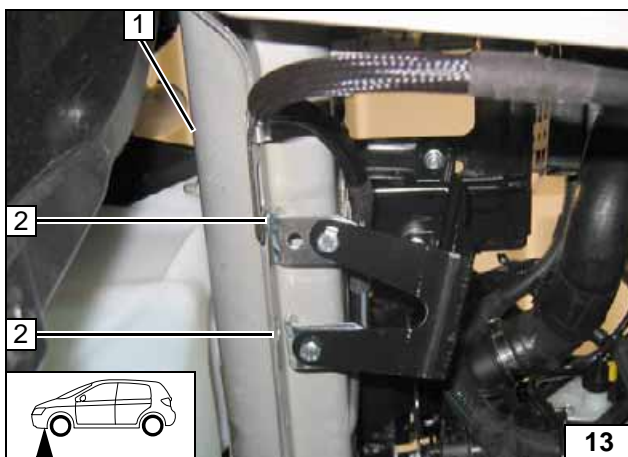

- 1 Frame side member
- 2 Copy hole pattern, drill 7.0 mm dia. hole [2x each]

**Copying hole pattern**

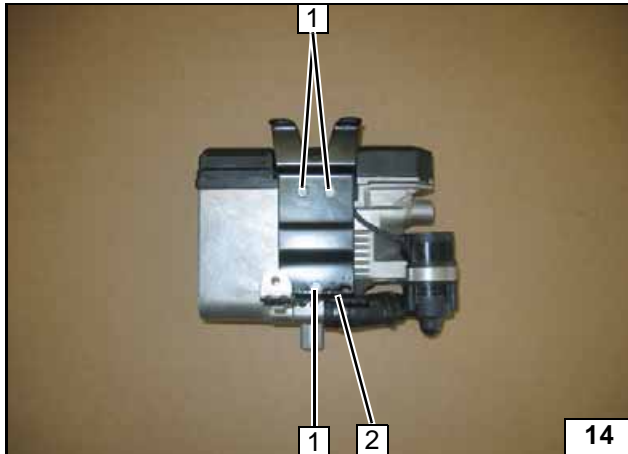
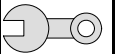

Remove angle bracket at position **2** again.

- 1 Ejet screw [3x]

Premounting heater

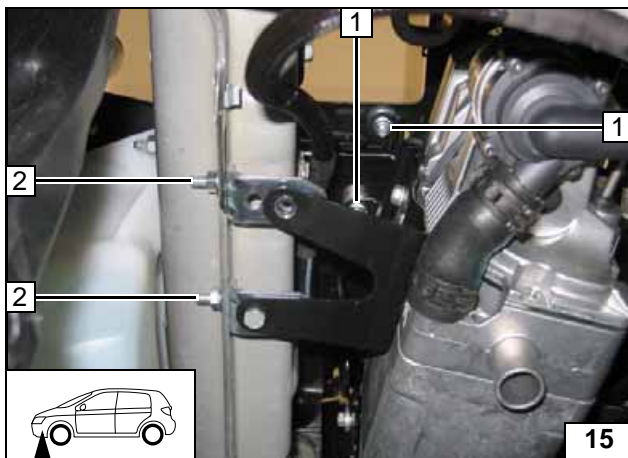

### Installing heater

Connect wiring harness of heater before installing heater.

- 1 Flanged nut [2x]
- 2 M6x20 bolt, flanged nut [2x each]



Installing heater

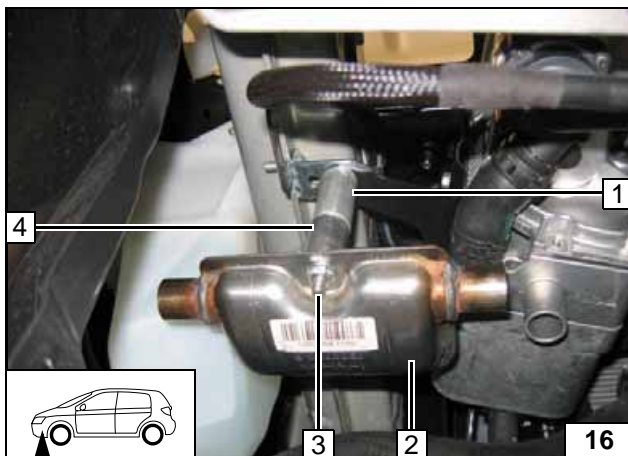

- 1 40 mm shim
- 2 Exhaust muffler
- 3 M6x90 bolt, flanged nut
- 4 30 mm shim

Installing muffler

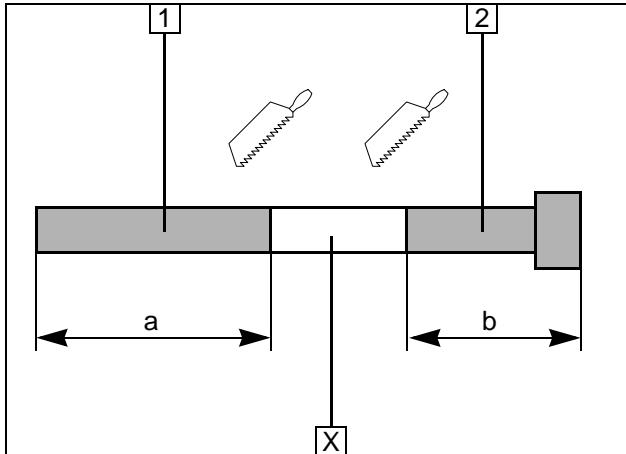
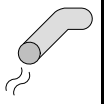

**Exhaust gas**

- 1 Exhaust pipe  
a = 210
- 2 Exhaust end section  
b = 380

Discard section X

**Preparing exhaust pipe**

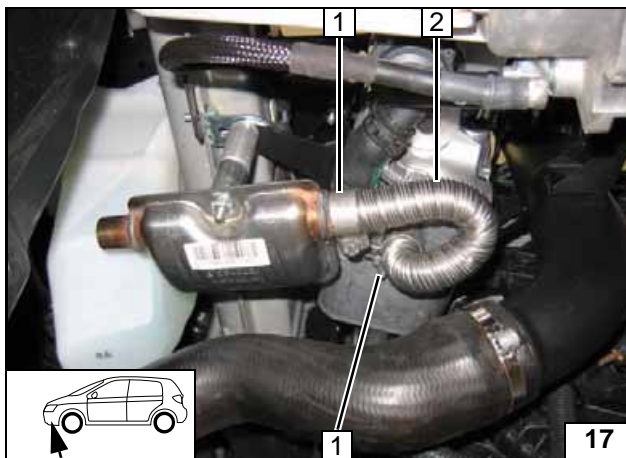

- 1 Hose clamp [2x]
- 2 Exhaust pipe

**Installing exhaust pipe**

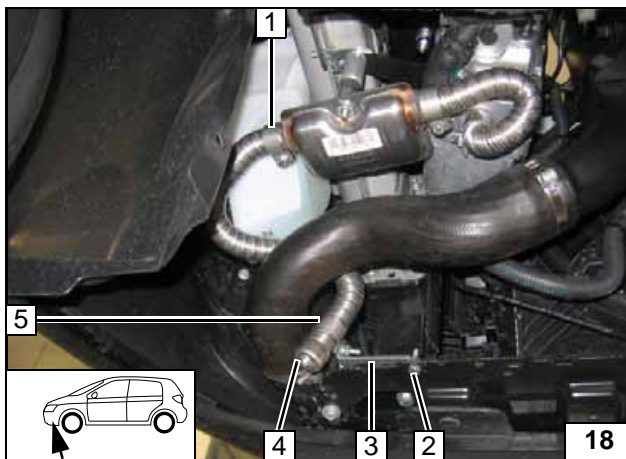

Bend perforated bracket 3 according to template.

- 1 Hose clamp
- 2 M6x20 bolt, flanged nut
- 4 Exhaust end section
- 5 Pipe clamp, M6x20 bolt, flanged nut

**Installing exhaust end section**



Ensure sufficient distance to neighbouring vehicle parts.

**Aligning exhaust end section**

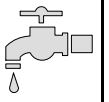



### Coolant circulation

**WARNING!**

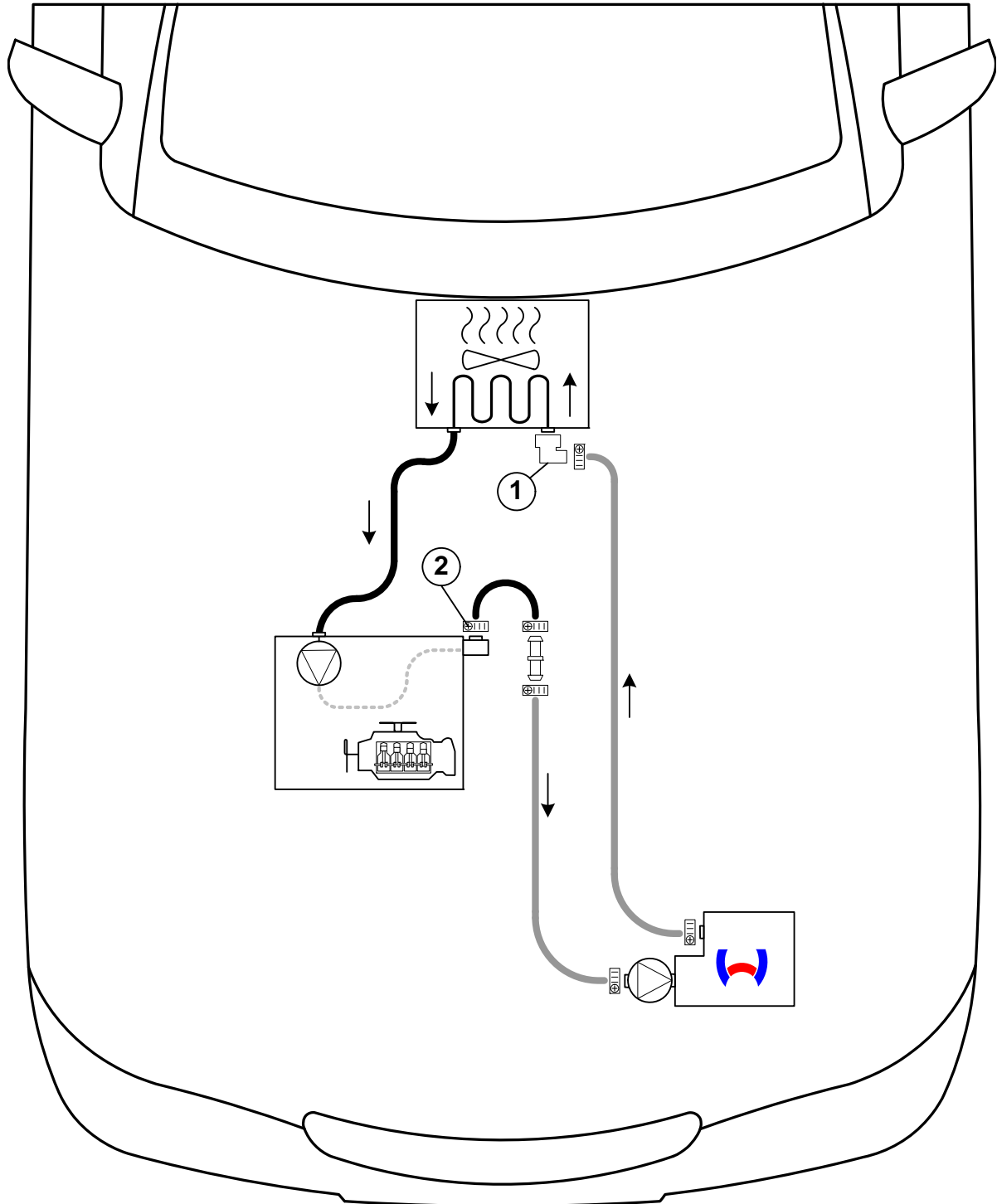
Any coolant running off should be collected using an appropriate container. Install hoses so that they are kink-free. Unless specified otherwise, always fasten using cable ties. Position clamps so that no other hose can be damaged! When installing the hoses, the heater must be filled with coolant. The connection should be "inline" based on the following diagram:



Hose installing diagram

All connecting pipes without a specific designation  = dia. 20x20. All hose clamps  = 20-27 mm dia.!  
**1** = Original vehicle coupling 90°! **2** = Hose clamp 16-20 mm dia.!



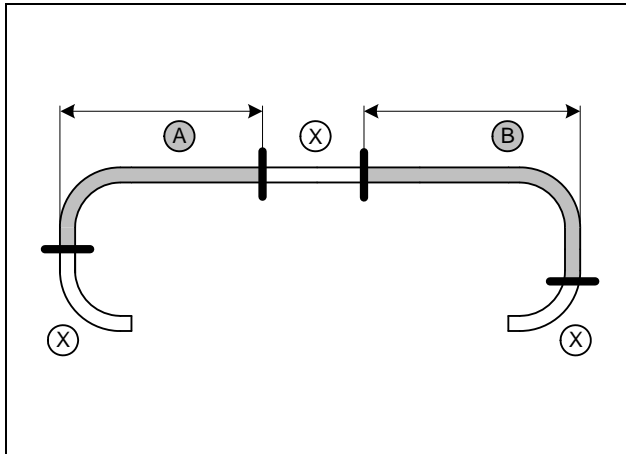

Discard section **X**.  
Hose **B** with long 90° elbow.

**A** = 510  
**B** = 580



**Cutting hose to length**

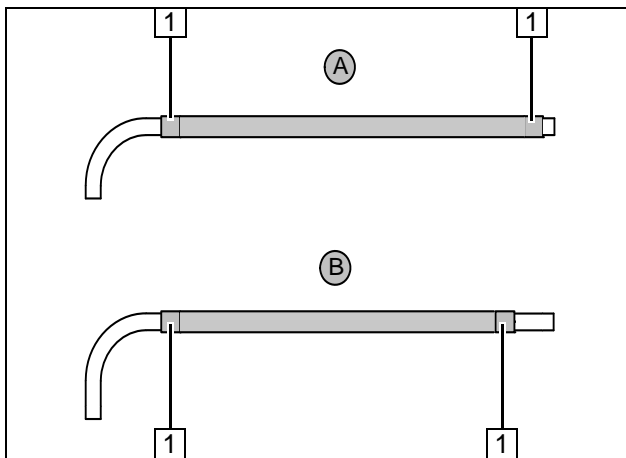

Cut braided protection hoses in half, slide onto hose **A** and **B** and cut to length. Cut heat shrink plastic tubing to length.

**1** 25 mm long heat shrink plastic tubing [4x]

**Braided protection hoses**

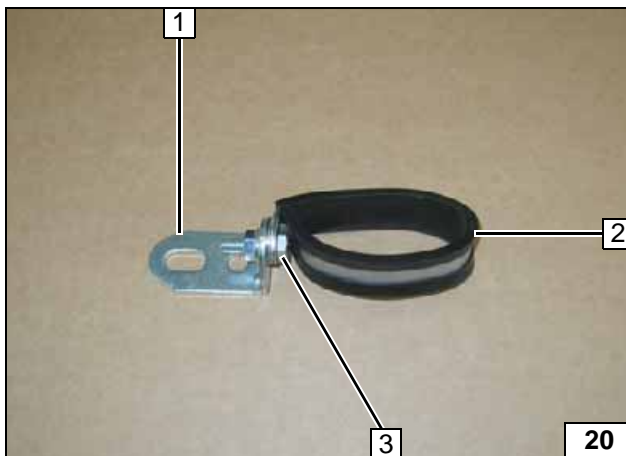

**1** Angle bracket  
**2** 48 mm dia. rubber-coated p-clamp  
**3** M6x20 bolt, flanged nut

**Premounting p-clamp**



**1** M6x20 bolt, washer, original vehicle hole, flanged nut

**Installing p-clamp**



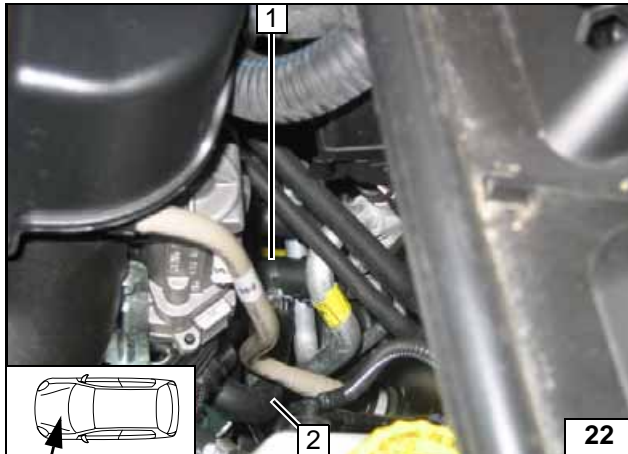
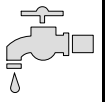

Remove hose section 2 from coupling of heat exchanger 1 and engine outlet. Discard clamps.



Cutting point

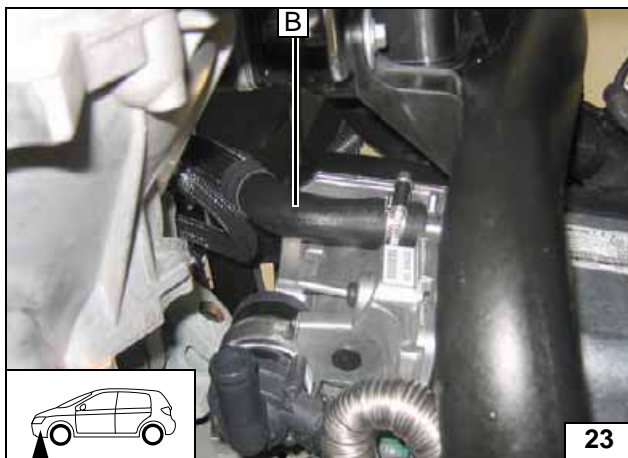

Connection of hose B on heater

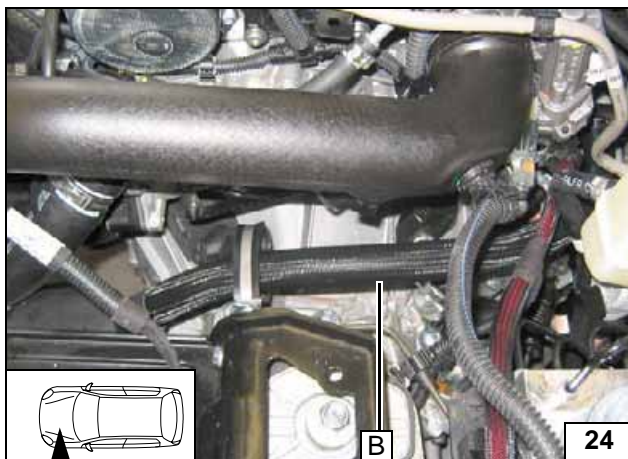

Routing in engine compartment

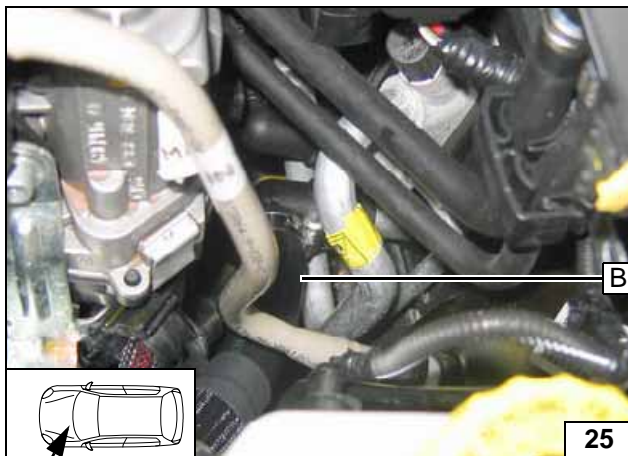

Connecting heat exchanger inlet

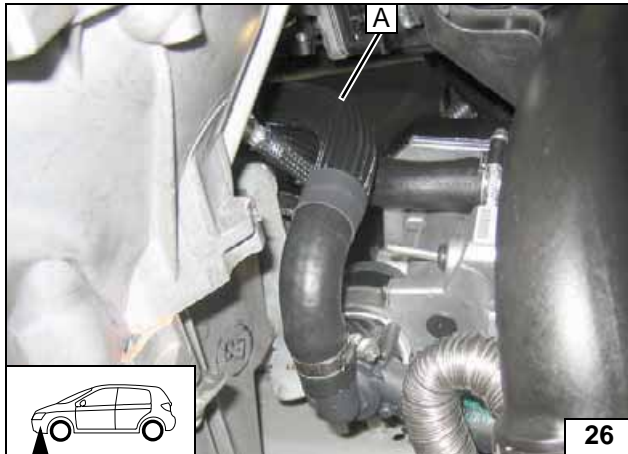

Ensure sufficient distance to neighbouring components.

- 1 Hose on heat exchanger inlet



Connec-  
tion of  
hose A on  
heater

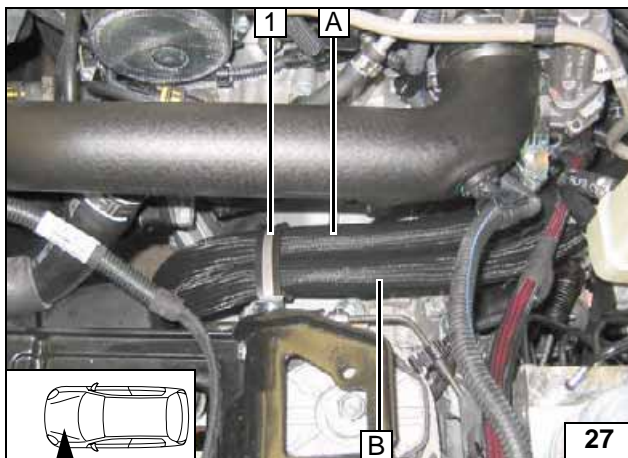

- 1 48 mm dia. rubber-coated p-clamp

Routing in  
engine  
compart-  
ment

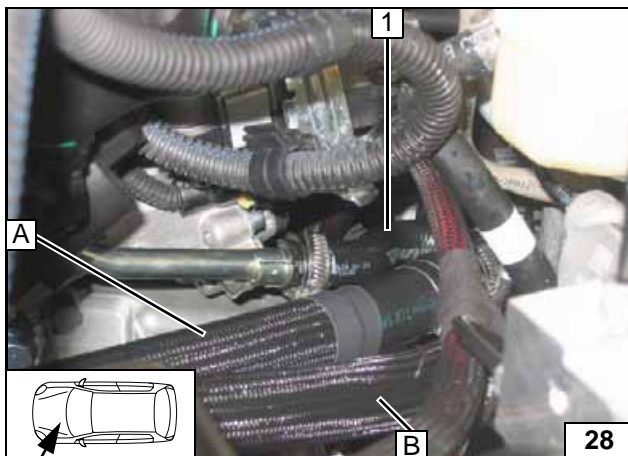

- 1 Hose on engine outlet turned 180°

Connect-  
ing engine  
outlet



**Fuel**

**CAUTION!**

Open the vehicle's fuel tank lock, ventilate the fuel tank and then re-close the tank lock.

Catch any fuel running off with an appropriate container.

Install fuel line and metering-pump wiring harness so that they are protected against stone impact. Unless specified otherwise, always fasten using cable ties. Mount the fuel line and wiring harness with rub protection on sharp edges.

**WARNING!**

The fuel line and wiring harness are routed to the metering pump in as shown in the wiring harness routing diagram.

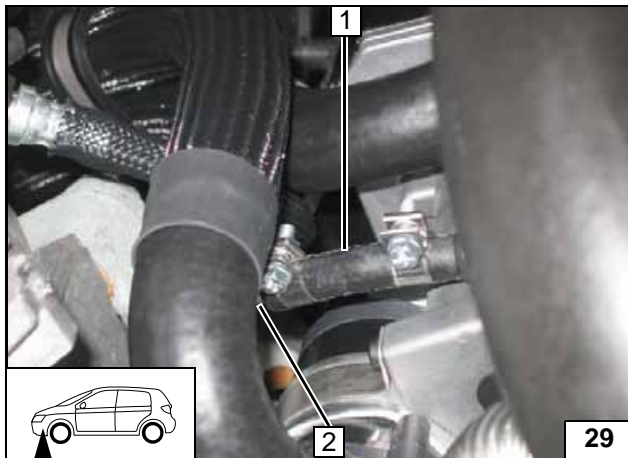

- 1 Hose section, 10 mm dia. clamp [2x]
- 2 Fuel line

Connec-  
tion to  
heater

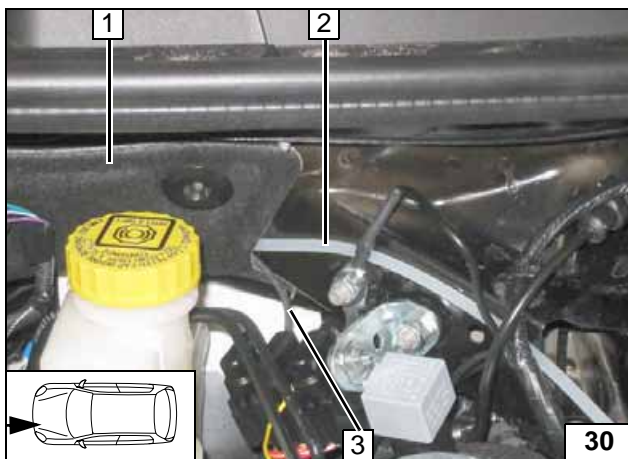

Route fuel line 2 and wiring harness of metering pump 3 behind original vehicle trim 1 to right-hand side of vehicle.



Installing  
lines

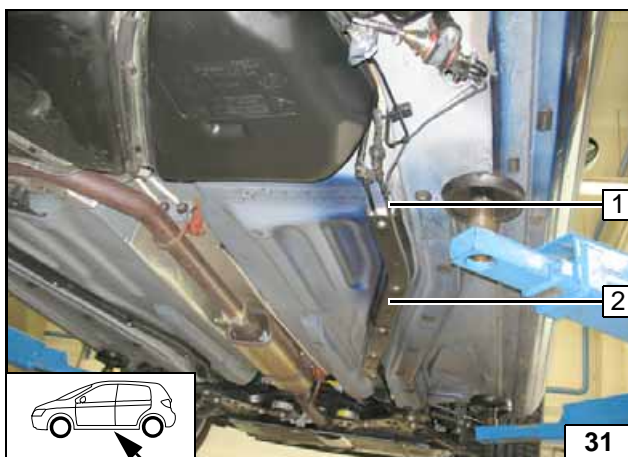

Route fuel line and wiring harness of metering pump 1 in original vehicle cover of fuel line 2.



Installing  
lines

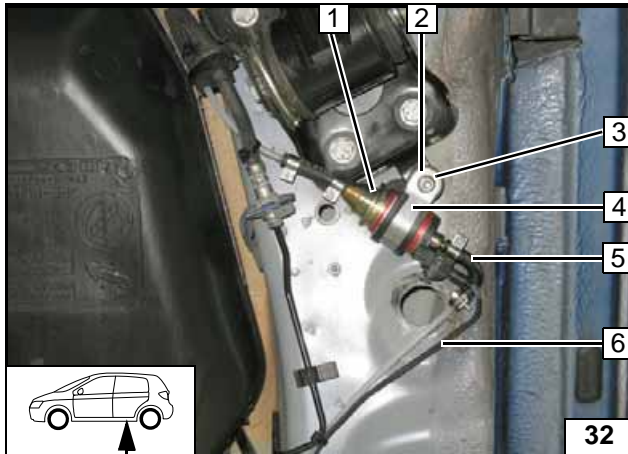

- 1 Metering pump
- 2 Original vehicle hole
- 3 Silent block, flanged nut [2x]
- 4 Rubber-coated pipe clamp
- 5 90° moulded hose, 10 mm dia. clamp [2x], fuel line
- 6 Metering pump wiring harness



**Installing metering pump**

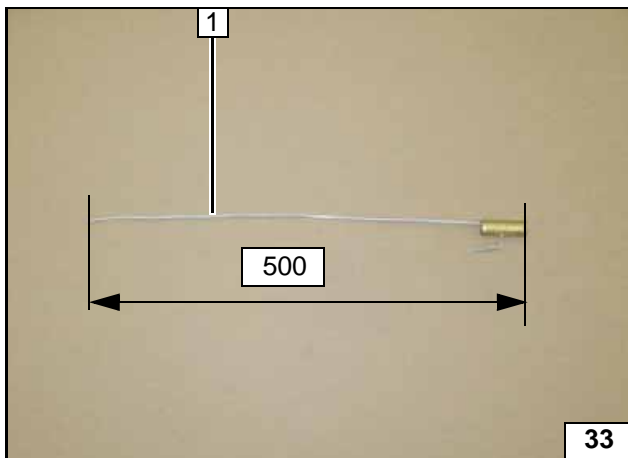

Cut fuel standpipe 1 to length.



**Cutting fuel standpipe to length**

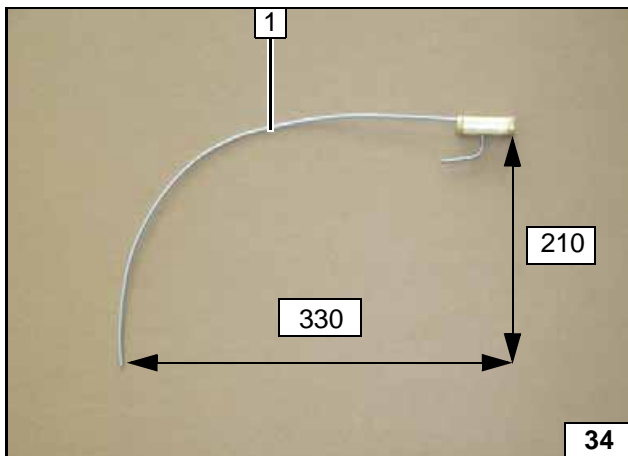

Shape fuel standpipe 1.



**Shaping fuel standpipe**

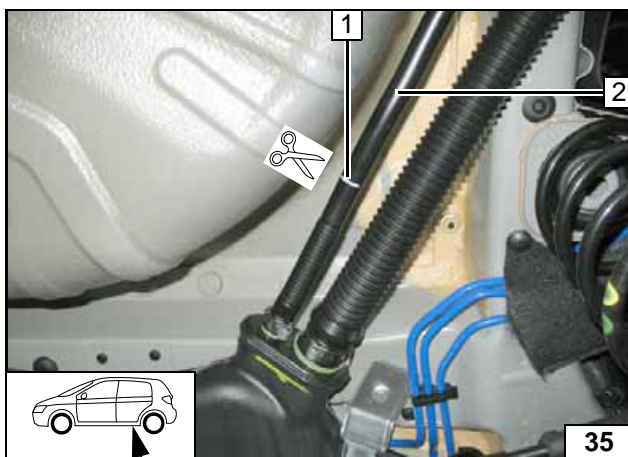

- 1 Cutting point
- 2 Fuel-tank vent line



**Removing fuel**

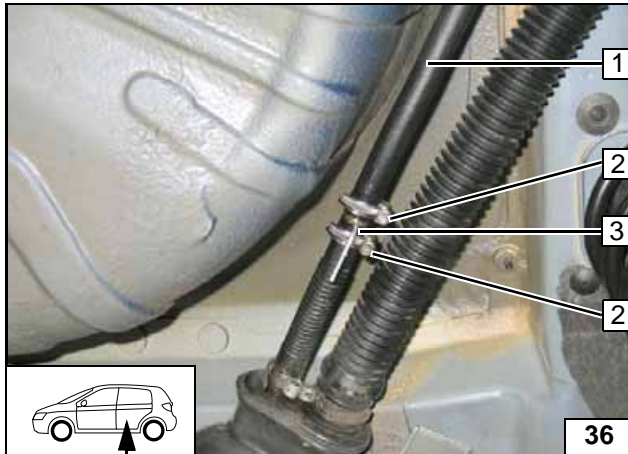

Mount fuel standpipe **3** in fuel- tank vent line **1**. Align removal pipe of fuel standpipe to fuel tank bottom.

**2** Hose section, 16-24 mm dia. clamp [2x]



Connect-  
ing to me-  
tering  
pump

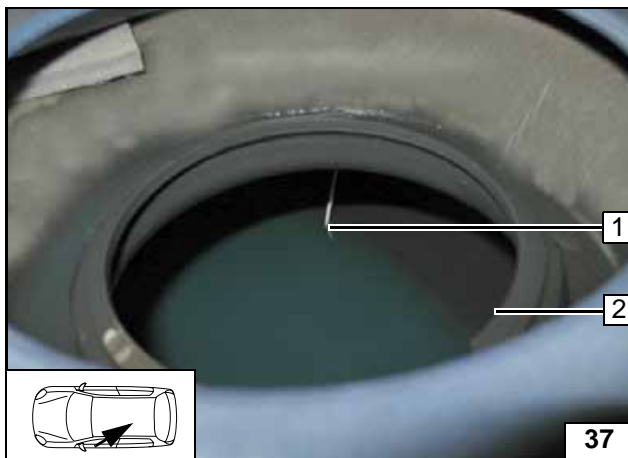

Align fuel standpipe **1** so that freedom of movement of fuel gauge is ensured after mounting fuel-tank sending unit.

**2** Opening of fuel-tank sending unit



Removing  
fuel

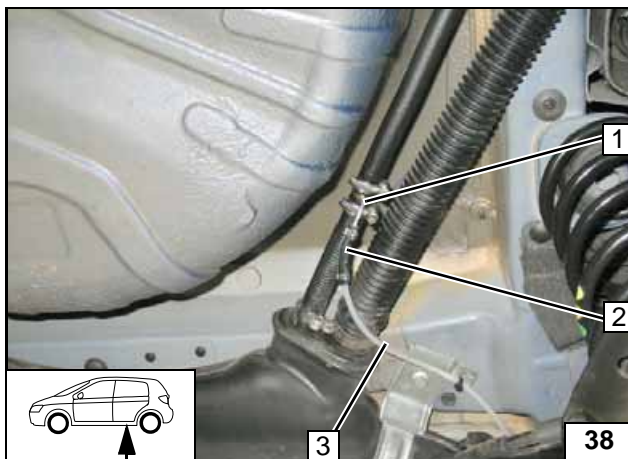

**1** Fuel standpipe

**2** Hose section, 10 mm dia. clamp [2x]

**3** Fuel line



Connect-  
ing fuel  
line

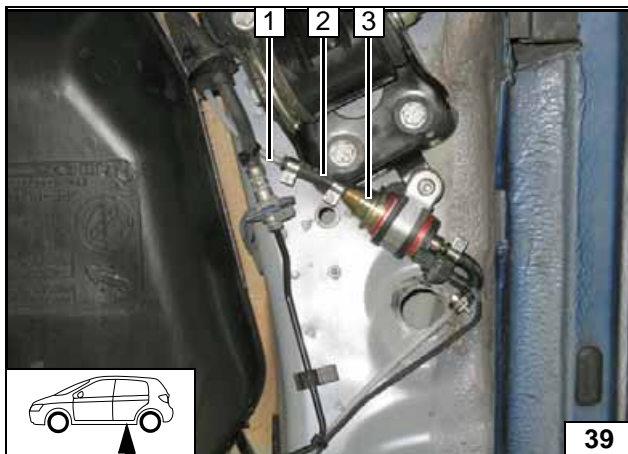

**1** Fuel line

**2** Hose section, 10 mm dia. clamp [2x]

**3** Metering pump



Installing  
metering  
pump

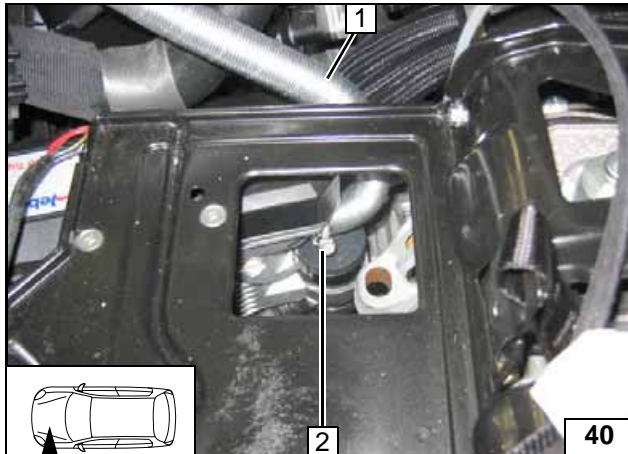
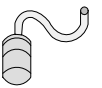

**Combustion air**

- 1 Intake pipe
- 2 27 mm dia. clamp

**Installing intake pipe**

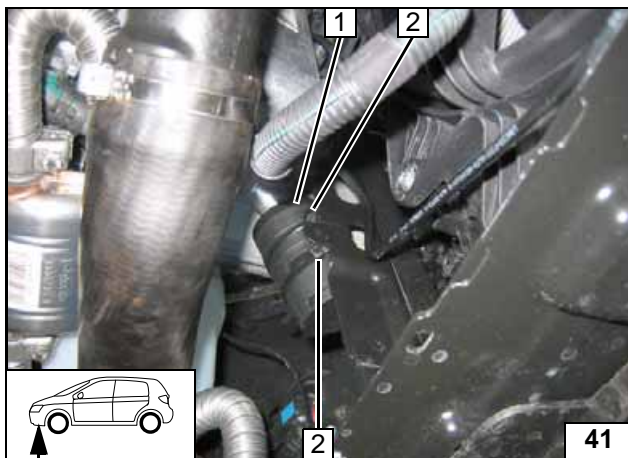

- 1 Intake muffler
- 2 Cable tie, original vehicle hole [2x]



**Installing muffler**

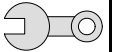

## Final Work

### WARNING!

Reassemble the disassembled components in reverse order.

Check all hoses, clamps and all electrical connections for firm seating.

Secure all loose cables using cable ties.

Only use manufacturer-approved coolant.

Spray the heater components with anti-corrosion wax (Tectyl 100K, Order No. 111329).

- Connect the battery.
- Fill and bleed the coolant circuit according to the vehicle manufacturer's specifications.
- Adjust digital timer, try out telestart
- Make settings on A/C control panel according to the "Operating Instructions for End Customer".
- Check the proper operation of the parking heater, see the operating instructions/installation instructions.
- Place the "Switch the parking heater off before refueling" signboard in the area of the filling branch



Webasto AG  
Postfach 80  
D-82132 Stockdorf / Germany  
National Hotline: 01805 93 22 78  
(14 Cent aus dem deutschen Festnetz)  
Hotfax: 0395 5592 353  
Hotmail: hotline@webasto.de  
<http://www.webasto.de>

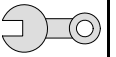

Template for Bracket

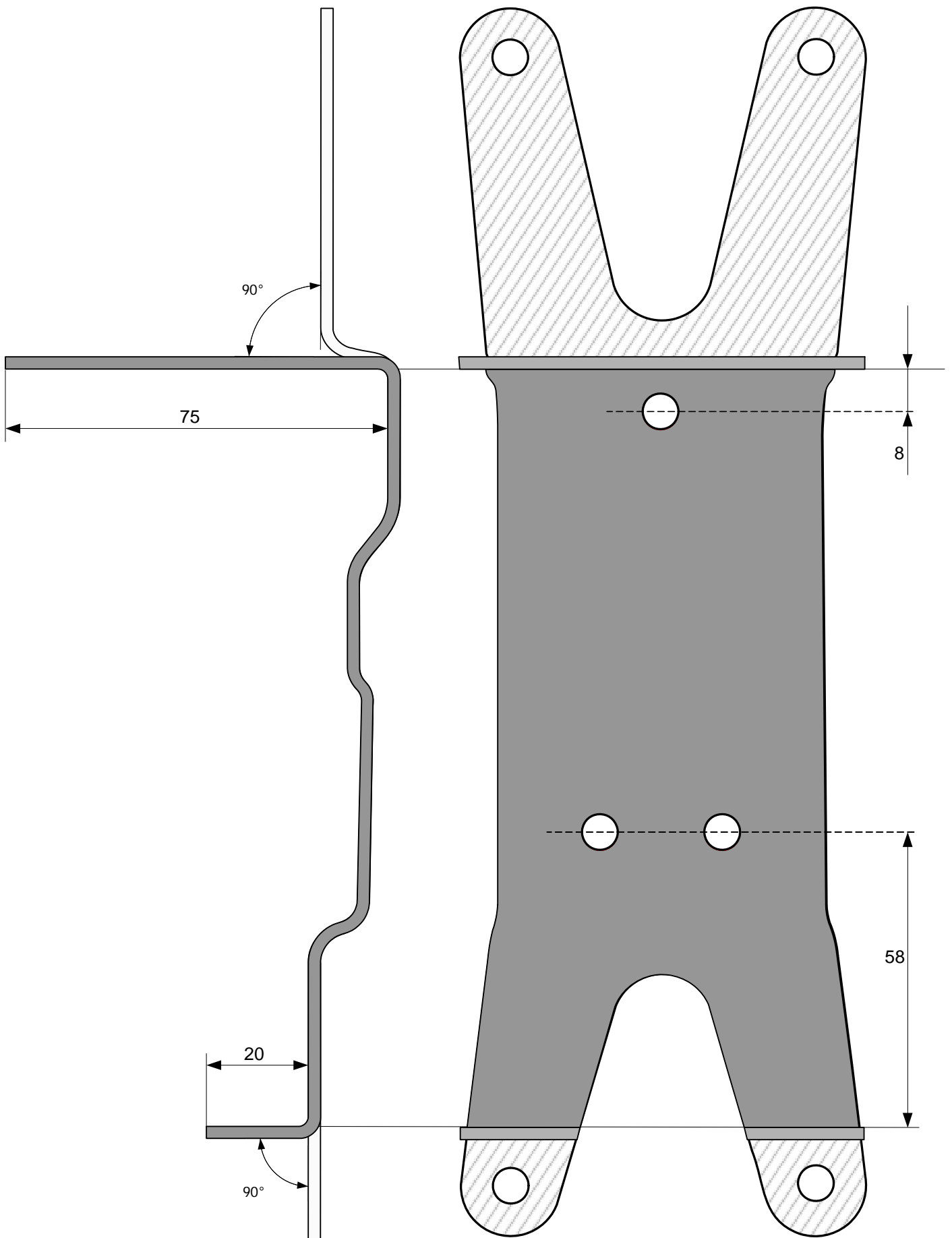



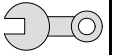

Template for Perforated Fastening Strap

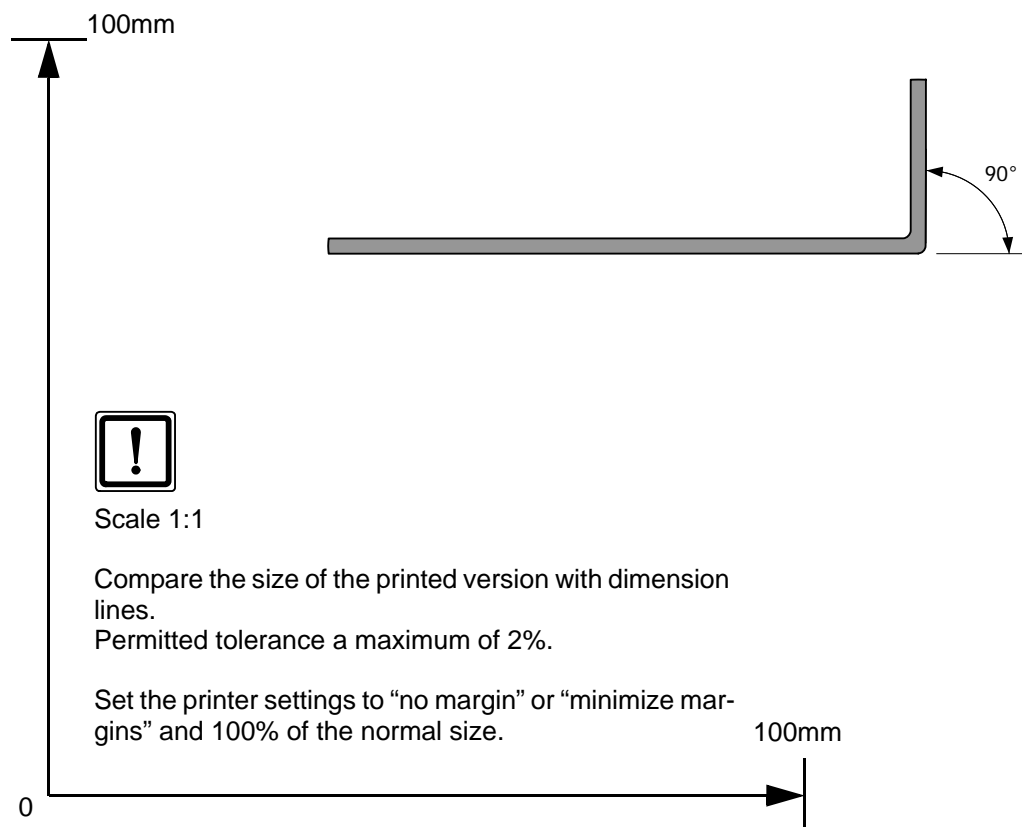
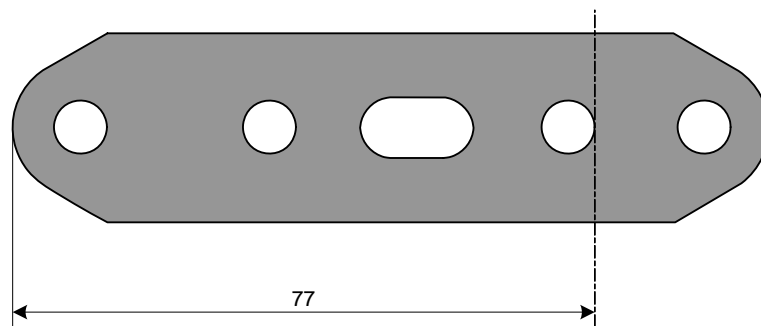

Scale 1:1

Compare the size of the printed version with dimension lines.

Permitted tolerance a maximum of 2%.

Set the printer settings to "no margin" or "minimize margins" and 100% of the normal size.

**Operating Instructions for End Customer**



Please remove page and add to the vehicle operating instructions.

**Note:**

We recommend matching the heating time to the driving time.

Heating time = driving time

**Example:**

For a driving time of approx. 20 min. (in one direction), we recommend not exceeding a switch-on time of 20 min.

If the summer/winter switch option has been installed, this must be switched in accordance with the time of year. The heater will then only switch on the vehicle fan to ventilate the vehicle interior in the position Winter heat and in the position Summer .



Before parking the vehicle, make the following settings:

**Note:**

On vehicles with a factory installed alarm system with passenger compartment monitoring, this must be deactivated before leaving the vehicle. Please see the owner's manual of the vehicle for additional information.

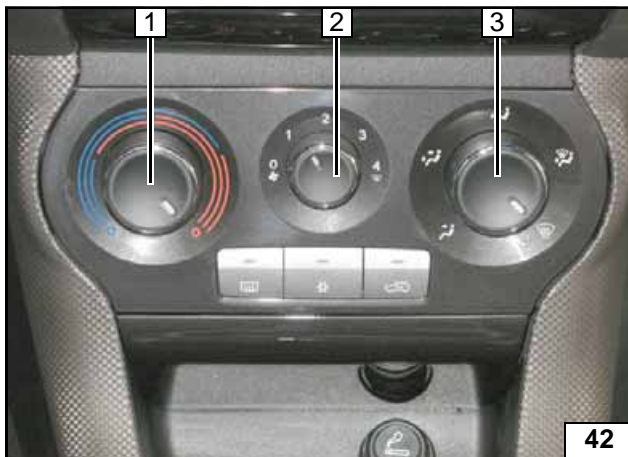

- 1 Set temperature to "max."
- 2 Set fan to level "1", or possibly "2"
- 3 Air outlet to windshield

**Manual air conditioning**



- 1 Air outlet to windshield
- 2 Set fan to level "1", or possibly "2"
- 3 Set temperature to "HI"

**Automatic air-conditioning**