

Water Heater Unit



Thermo Top V Additional Heater ^{e1} 00 0018

Installation Instructions

Citroen C5 / Peugeot 407

2.7 HDI

from Model Year 2008

Left-hand drive vehicle

Automatic air-conditioning

Automatic transmission



WARNING!

Hazard warning:

Incorrect installation or repair of Webasto heating systems may cause a fire or result in the emission of carbon monoxide, which can be fatal. Serious or fatal injuries can be caused as a result.

Specialist company training, technical documentation, specialized tools and equipment are required to install and repair Webasto heating and cooling systems.

NEVER attempt to install or repair Webasto heating or cooling systems if you have not successfully completed the company training and thereby acquired the required technical skills, or if you do not have access to the required technical documentation, tools and equipment needed to carry out correct installation and repairs.

ALWAYS follow all Webasto installation and repair instructions and observe all warnings.

Webasto does not accept any liability for defects and damage that are attributable to installation by untrained staff.

Table of Contents

Validity	2	Fan controller	8
Heater Unit/Installation Kit	3	Heater controls	10
Foreword	3	Digital timer option	11
General Instructions	3	Remote option (Telestart)	11
Special Tools	3	Preparing installation location	13
Explanatory Notes on Document	4	Installing heater unit	13
Preliminary Work	5	Coolant	14
Heater unit installation location	5	Fuel	16
Preparing electrical system	6	Final Work	19
Electrical system	7	Template for Fuel Standpipe	20

Validity

Manufacturer	Model	Type	EG-BE No./ABE
Citroen	C5	R....	e2 * 2001/116 * 0360 * ...

Manufacturer	Model	Type	EG-BE No./ABE
Peugeot	407	6	e2 * 2001/116 * 0328 * ...

Engine type	Engine model	Output in kW	Displacement in cm ³
UHZ	Diesel	150	2720

Vehicle and engine types, equipment variants and national specifications not listed in these installation instructions have not been tested. However, installation according to these installation instructions may be possible.

The installation location of the digital timer should be confirmed with the end customer before installation.

Heater Unit/Installation Kit

Quantity	Description	Order No.:
1	Delivery Scope of Citroen C5 / Peugeot 407 Diesel Automatic Transmission	1313878B

Optional heater control either:

Quantity	Description	Order No.:
1	Digital timer	See price list
1	Telestart T91	See price list
1	Telestart T100 HTM	See price list
1	Y-adapter (with combination of digital timer and Telestart)	9001505A

Foreword

These installation instructions apply to Citroen C5 / Peugeot 407 2.7 HDI vehicles - for validity, see page 2 - from model year 2008 and later, assuming technical modifications to the vehicle do not affect installation, any liability claims excluded. Depending on the vehicle version and equipment, modifications may be necessary during installation with respect to these installation instructions.

However, where this is the case the stipulations in the "installation instructions" and "operating and maintenance instructions" for the *Thermo Top V* should be observed. The corresponding rules of technology and any information from the vehicle manufacturer should be observed during the installation work.

General Instructions

Installation should be carried out according to the general, standard rules of technology. Unless specified otherwise, fasten hoses, lines and wiring harnesses to original vehicle lines and wiring harnesses using cable ties.

Sharp edges should be fitted with edge protectors (split-open plastic hose).

Spray unfinished body areas, e.g. drilled holes, with anti-corrosion wax (Tectyl 100K, Order No. 111329).

Special Tools

- Torque wrench for 2.0 - 10 Nm
- Hose clamping pliers

Explanatory Notes on Document

To provide you with a quick overview of the individual working steps, you will find an identification mark on the outside top right corner of the page in question.

Mechanical system

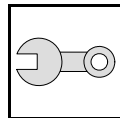

Electrical system

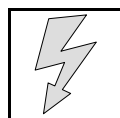

Water

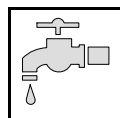

Fuel

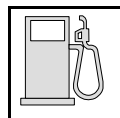

Exhaust gas

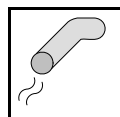

Combustion air

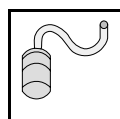

Special features are highlighted using the following symbols:



Specific risk of injury or fatal accidents.



Specific risk of damage to components.



Specific risk of fire or explosion.



Reference to general installation instructions of Webasto components or to the manufacturer's vehicle-specific documents.



Reference to a special technical feature.

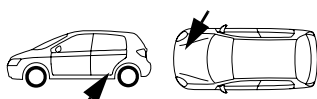

The arrow in the vehicle icon indicates the position on the vehicle and the viewing angle.

All dimensions are in mm!

Tightening torque of hose clamps = 2.0 + 0.5 Nm!

Tightening torque of Ejet screws, Ejet studs = 10 Nm!

Preliminary Work

WARNING!

- Open fuel tank cap, ventilate tank.
- Close the tank cap again.
- Disconnect the battery "earth" or "ground" connection.
- Depressurize the cooling system.
- Copy the factory number from the original type label to the duplicate type label.
- Remove years that do not apply from the duplicate label.
- Attach the duplicate label (type label) in the appropriate place.
- Remove the left-hand wheel well trim.
- Remove the left front wheel.
- Remove the front underride protection.
- Remove the right rear underride protection.
- Fold over the right-hand rear seat
- Open the right-hand fuel sender service lid.
- Remove the instrument panel trim on the driver's side (only with Telestart).
- Remove the footwell trim on the driver's side.
- Remove the driver's side storage compartment.

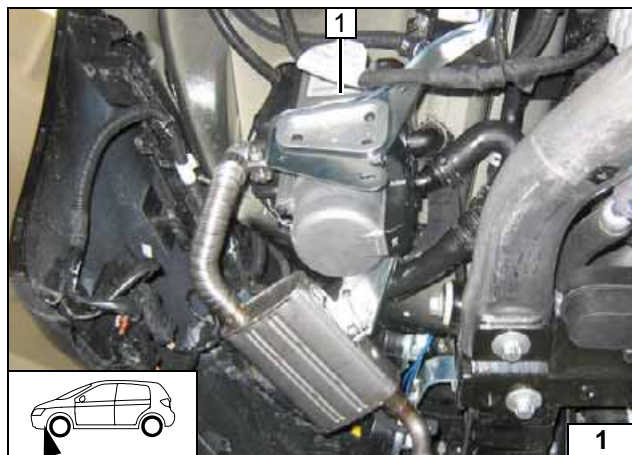

Heater unit installation location

1 Heater unit

Installation location

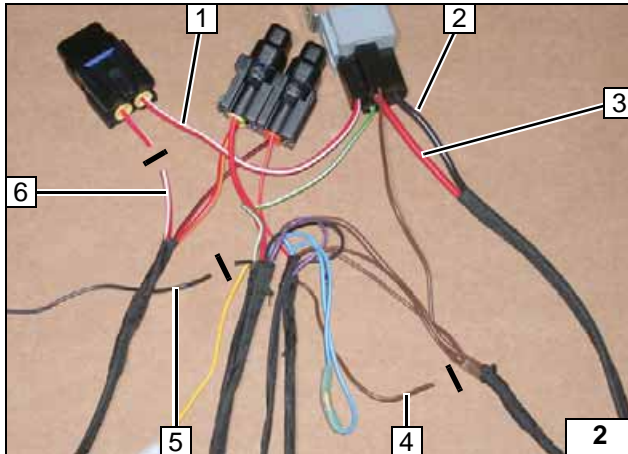
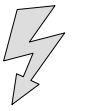

Preparing electrical system

Cut off black (sw) wire 5 (0.75 mm²) from wiring harness of heater unit. Cut off red/white (rt/ws) wire 6 (4 mm²) of fuse F3. Remove insulation from ground wires to node point and cut off brown (br) wire 4 (0.75 mm²) from wiring harness of digital timer.

Remove red/white (rt/ws) wire 1 (4 mm²) from K3/87, red (rt) wire 3 (4 mm²) from K3/87a and black (sw) wire 2 (4 mm²) from K3/30.



Preparing fuse F3 and K3 relay

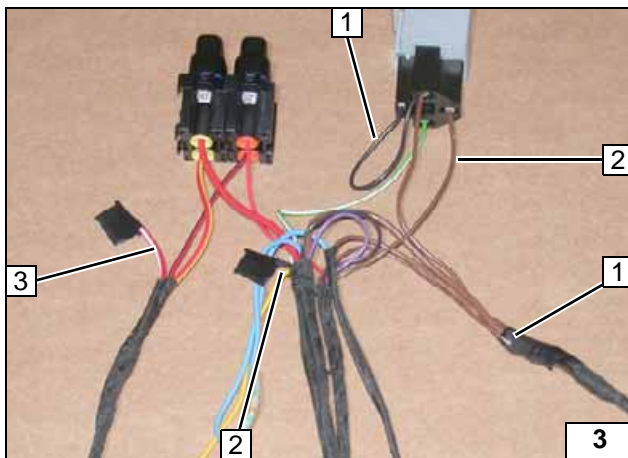

Insulate and tie back ends of red/white (rt/ws) wire 3 and black (sw) wire 2. Insulate ground wires 1.

Insert brown (br) wire 2 (0.75 mm²) from wiring harness of heater controls in K3/30. Also connect black (sw) wire 1 to K3/85 and to K3/87.



Preparing K3 relay

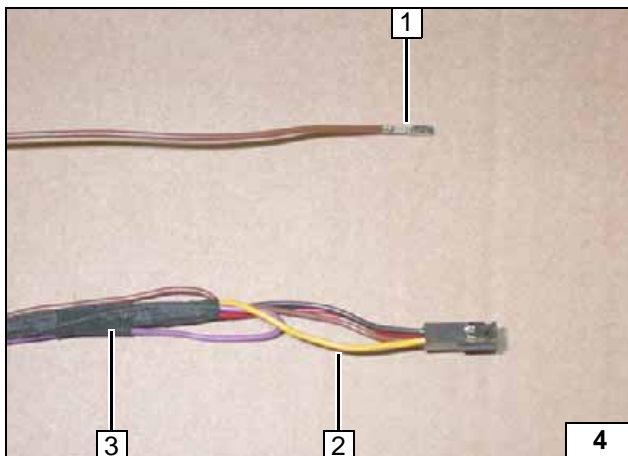

Strip insulation from approx. 50 mm of wiring harness of digital timer 3. Crimp microtimer 1 onto brown (br) wire (0.75 mm²). Insert yellow (ge) wire 2 in free socket of digital timer connector.



Preparing wiring harness of digital timer

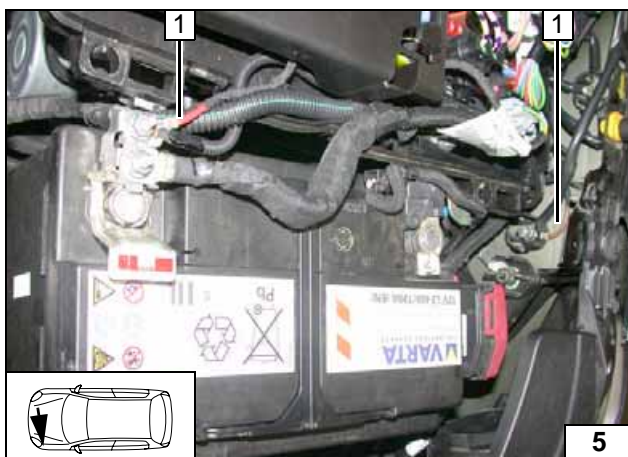
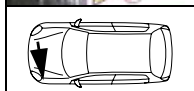

Illustration shows Citroen C5!
Connect positive wire 1 to positive terminal and ground wire 2 to original vehicle ground support point.



Positive and ground connection





Electrical system

Fuse holder, K3 relay on Citroen C5

- 1 Original vehicle bolt
- 2 Angle bracket
- 3 M5x16 bolt, retaining plate for fuse holder, large diameter washer, flanged nut
- 4 K3 relay

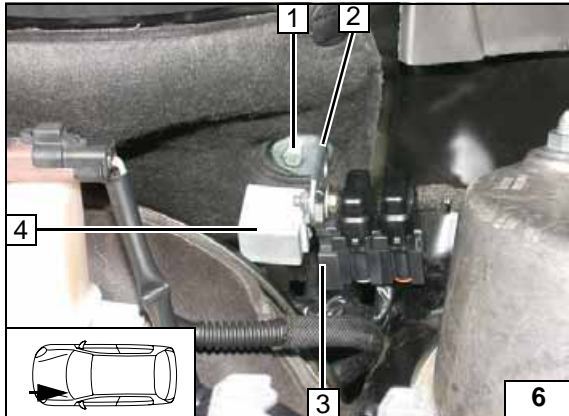

Fuse holder, K3 relay on Peugeot 407

- 1 K3 relay
- 2 Angle bracket
- 3 Original vehicle bolt
- 4 M5x16 bolt, retaining plate for fuse holder, large diameter washer, flanged nut

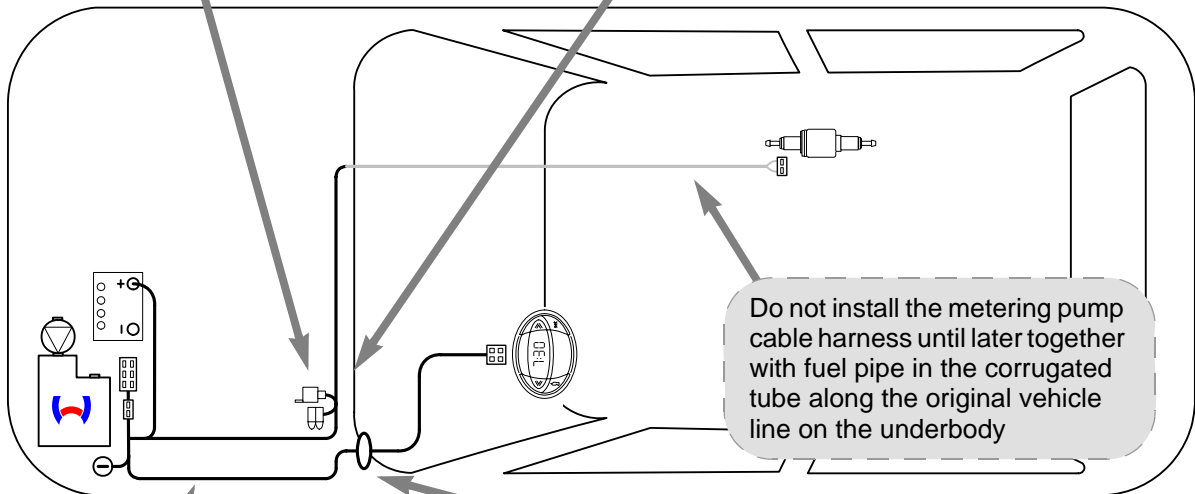
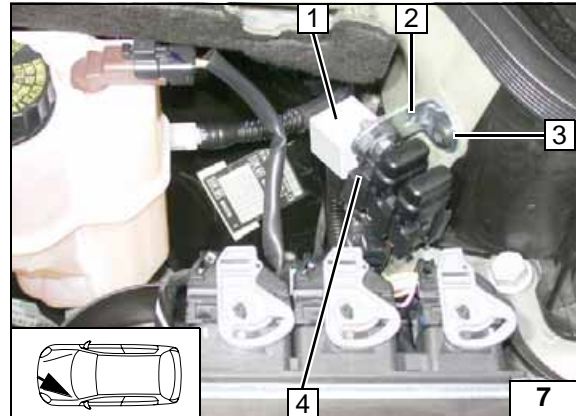

Wiring harness installation diagram

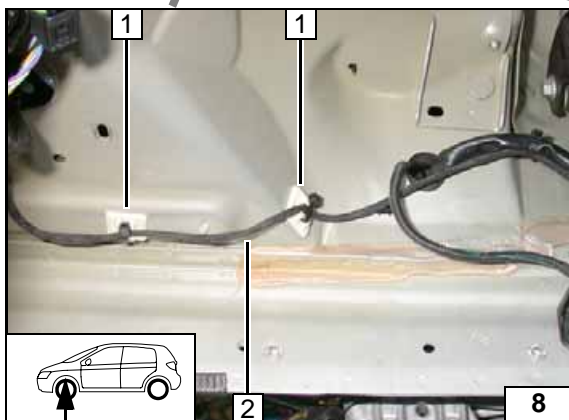

Wiring harness routing

Fasten wiring harness of digital timer **2** in wheel well with adhesive base **3** and cable tie [total of 4x each].

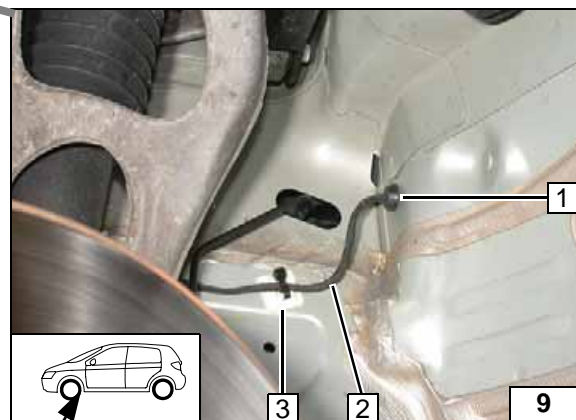

Wiring harness pass through of passenger compartment

- 1 Drill out existing protective rubber plug
- 2 Wiring harness of digital timer
- 3 Adhesive base, cable tie



Fan controller

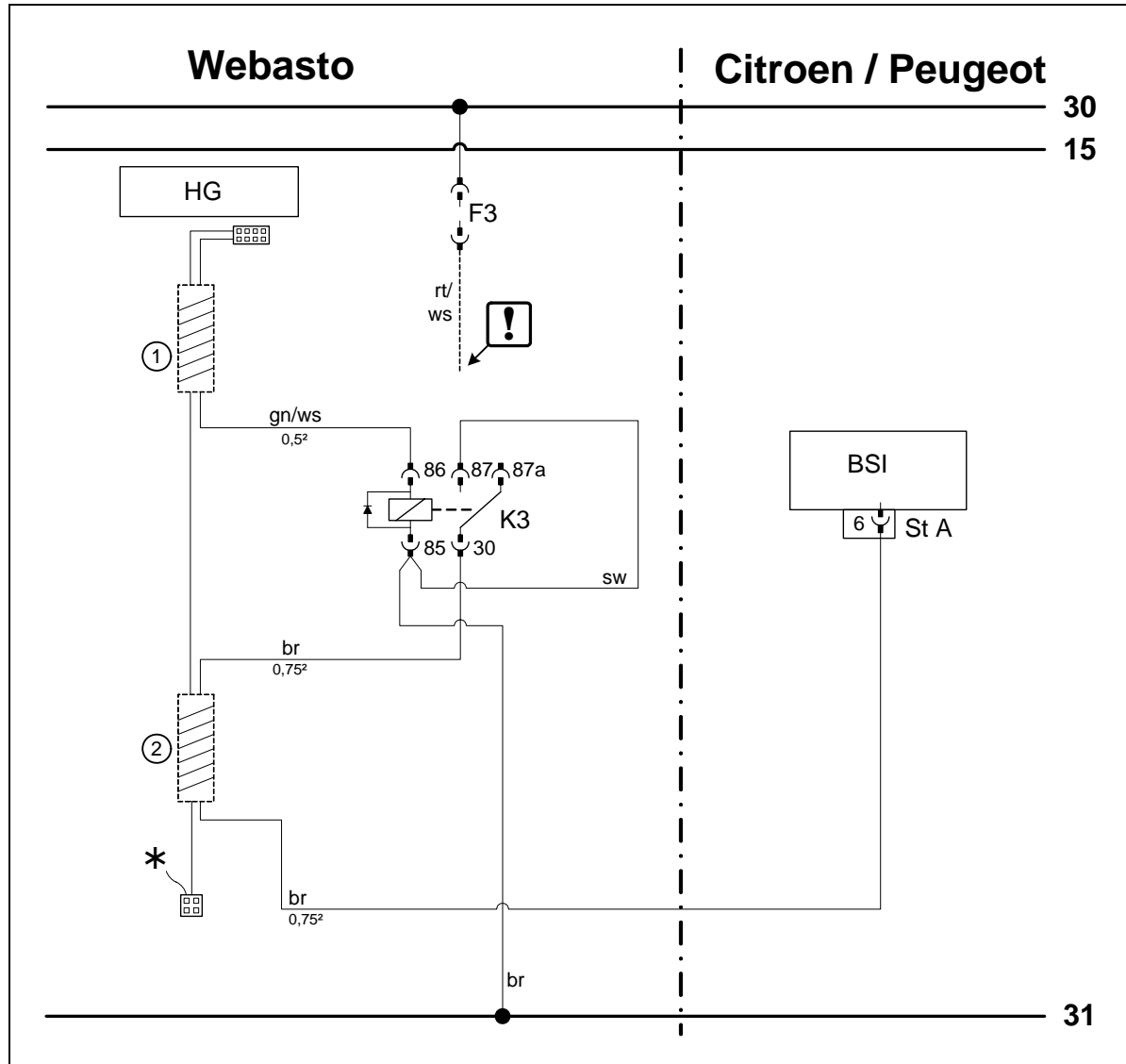

Wiring diagram

Webasto components		Vehicle components		Colors and symbols	
HG	Heater unit TT-C/E	BSI	Central electrical box for passenger compartment	gn	green
VWU	Digital timer			ws	white
Tele	Telestart	St A	20-pin connector BSI	rt	red
F3	Fuse removed			br	brown
①	Wiring harness of heater unit			sw	black
②	Wiring harness of digital timer				
				*	Mount yellow (ge) wire in free socket of 4-pin connector of heater-unit wiring harness.
				!	Insulate wire ends and tie back
					Cable and connector colors may vary!

Legend

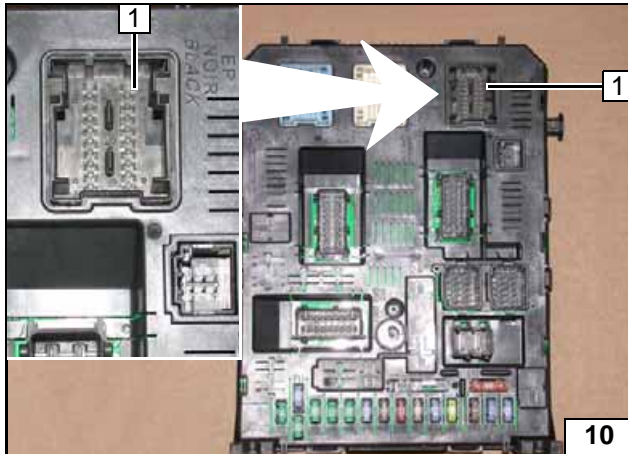

View of BSI.

1 Socket for 2-piece connector. 40-pin



Detaching BSI and routing downward

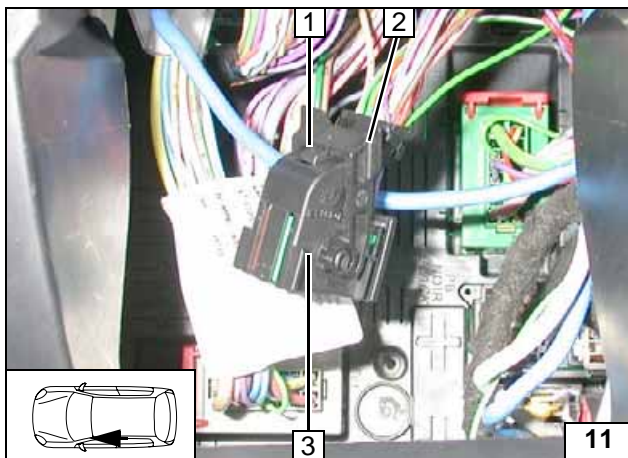

Press in locking lug 1 and fold down bar 2.

3 2-piece connector



Pulling connector off BSI and removing

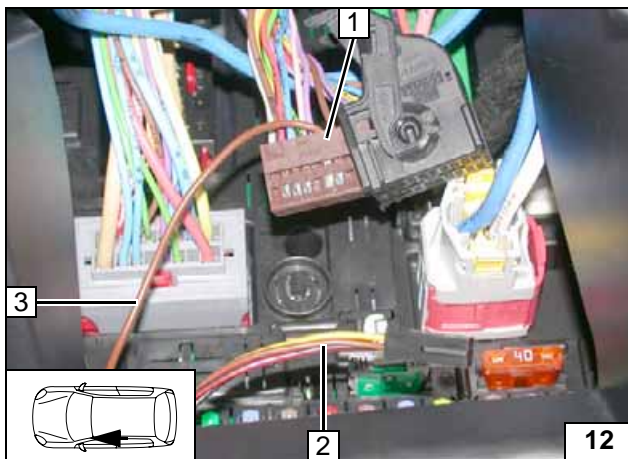

Connection on 20-pin connector 1 from BSI (connector color may vary)!
Insert microtimer from brown (br) wire 3 in PIN 6. Route wiring harness of digital timer 2 upward to installation location of digital timer. Produce connections as shown in wiring diagram.



Connection of BSI

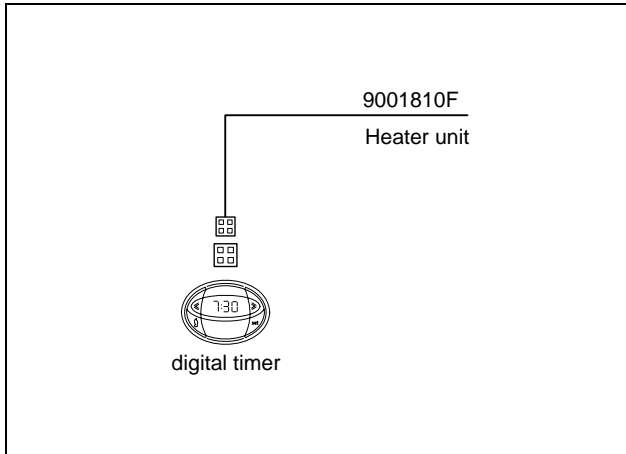

Heater controls

Digital timer only



Diagram for digital timer

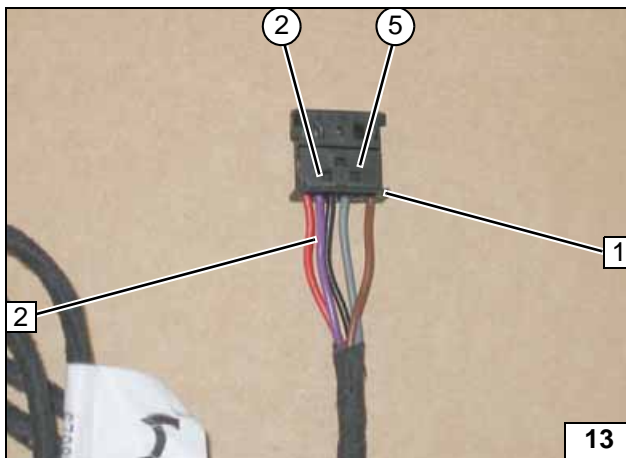

Telestart T91

Modify wiring harness from remote control set T91 as follows:



Remove violet (vi) wire 2 from socket 5 and insert in socket 2.

Preparing connector of Telestart receiver for T91

1 6-pin connector

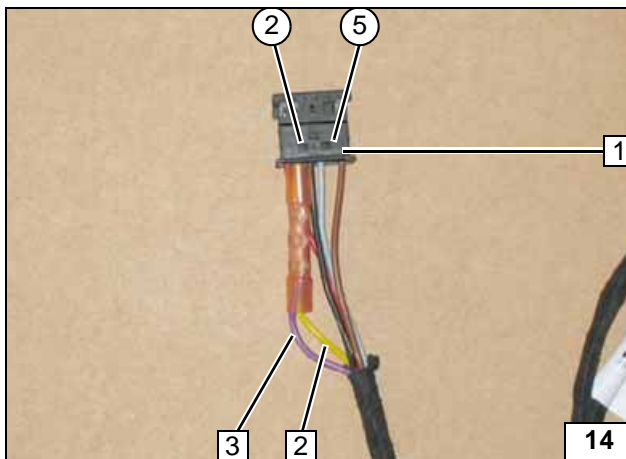

Telestart T100 HTM

Modify wiring harness from remote control set T100 as follows:



Disconnect yellow (ge) wire 2 from socket 2. Remove violet (vi) wire 3 from socket 5 and connect to yellow (ge) wire 2. Discard micro-timer of violet (vi) wire 3.

Preparing connector of Telestart receiver for T100 HTM

1 6-pin connector

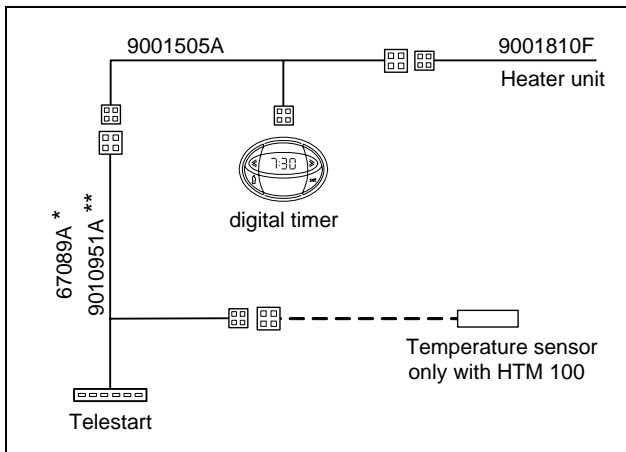

Switch-on display for Telestart in digital timer: "Tele On"!



Y-adapter with T91 = 67089A

Y-adapter with HTM 100 = 9010951A

Diagram for digital timer with Telestart



Digital timer option

Citroen C5

- 1 Digital timer

Installing digital timer



Peugeot 407

- 1 Digital timer

Installing digital timer

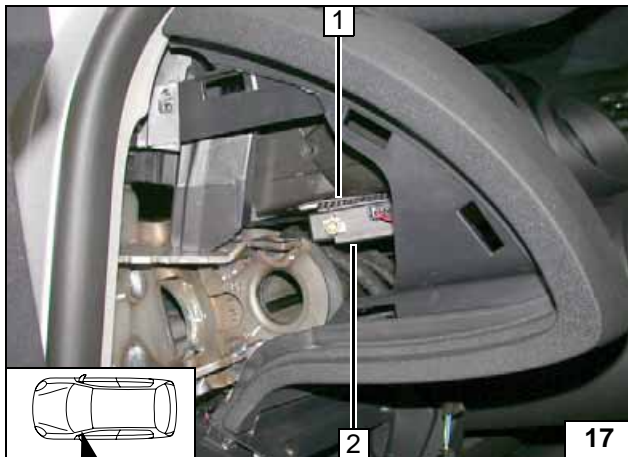

Remote option (Telestart)

Citroen C5

Mount connector (6-pin) from adapter wiring harness on receiver **2**.

- 1 Double-sided adhesive tape



Installing receiver

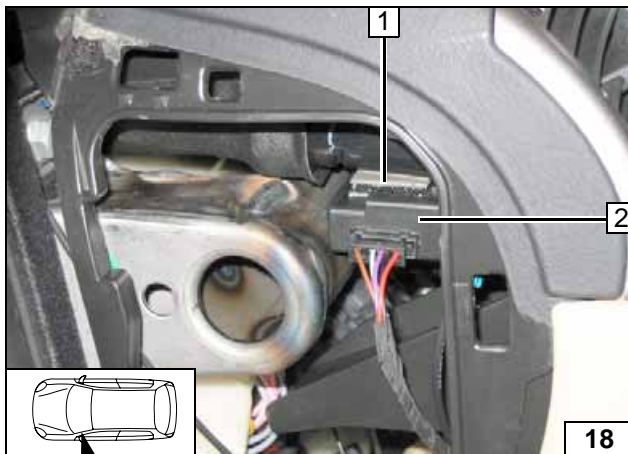

Peugeot 407

Mount connector (6-pin) from adapter wiring harness on receiver **2**.

- 1 Double-sided adhesive tape



Installing receiver

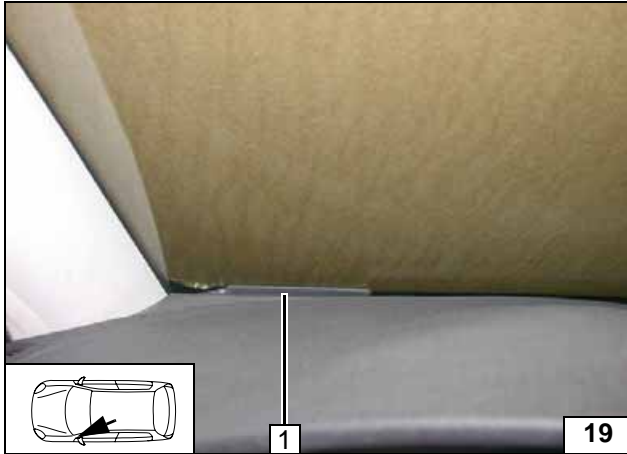

All vehicles

1 Antenna

Installing antenna

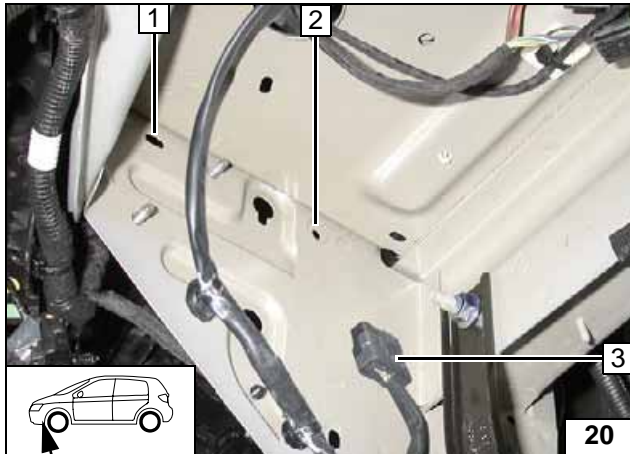
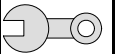

Preparing installation location

Move connector from position 2 (if present) to position 3.

- 1 Fastening point for heater unit (existing hole)
- 2 Fastening point for heater unit (existing hole)
- 3

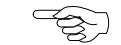

Repositioning connector

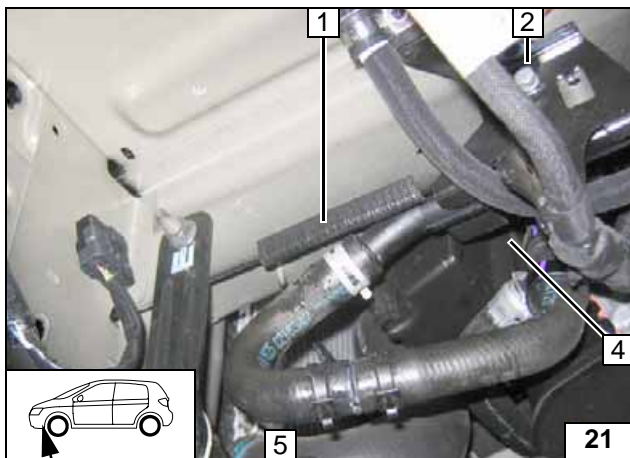

Loosen bolt at position 2 (fastening point for heater unit).

- 1 100 mm edge protection
- 4
- 5



Installing edge protection

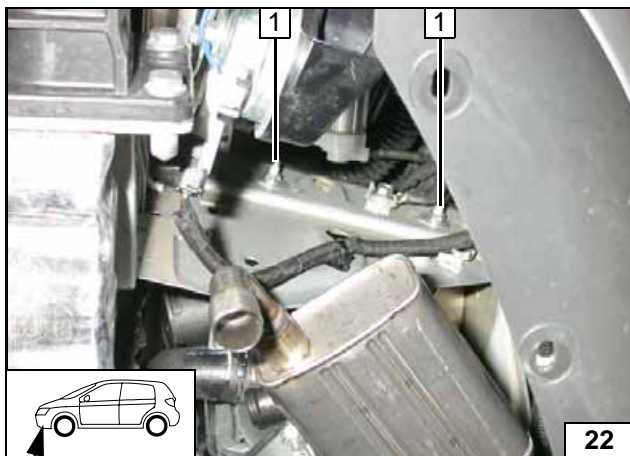

Installing heater unit

Mount stud bolts from bracket in existing holes.

- 1 Large diameter washer, flanged nut [2x each], stud bolt



Installing heater unit

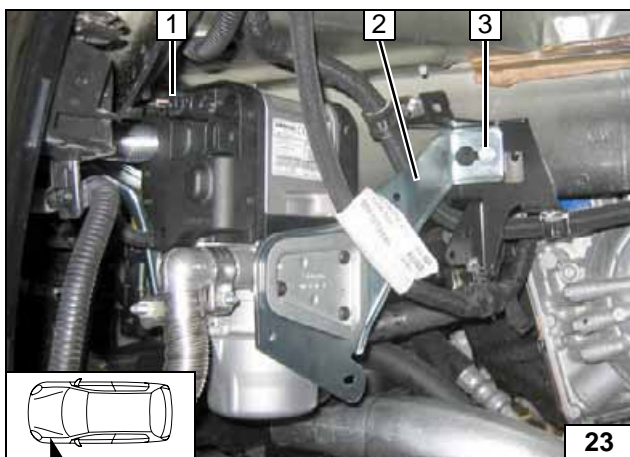

- 1 Mount wiring harness of heater unit
- 2 Bracket of heater unit
- 3 Original vehicle bolt

Installing bracket





Coolant

WARNING!

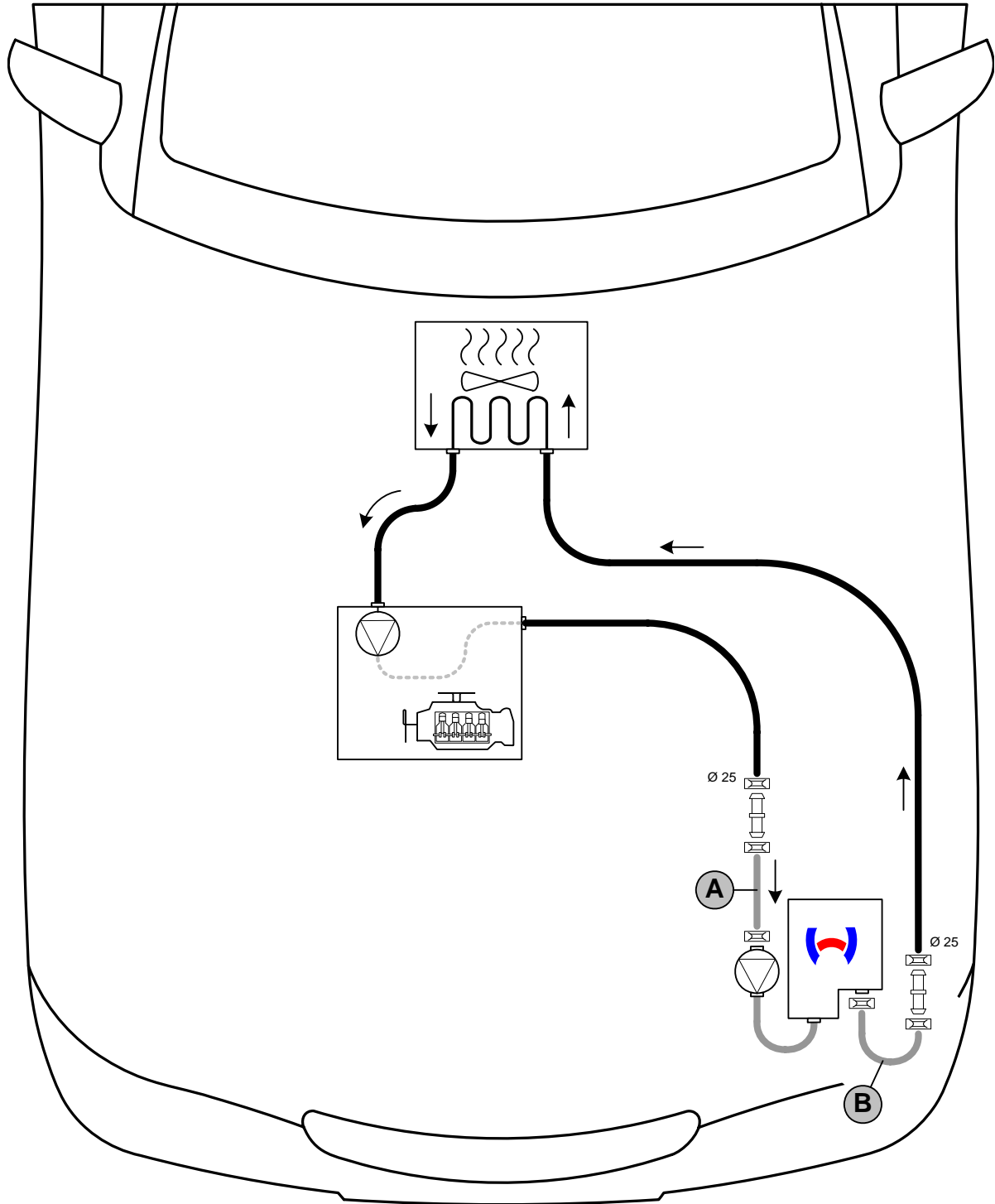
Any coolant running off should be collected using an appropriate container. Install coolant hoses kink-free. Unless specified otherwise, always fasten using cable ties. Position clamps so that no other hose can be damaged! When installing the coolant hose, the heater unit must be filled with coolant. The connection should be "inline" based on the following diagram:



Coolant routing diagram

All spring clips without a specific designation  = 27 mm dia.
 All connecting pipes  = 18x20 mm dia.



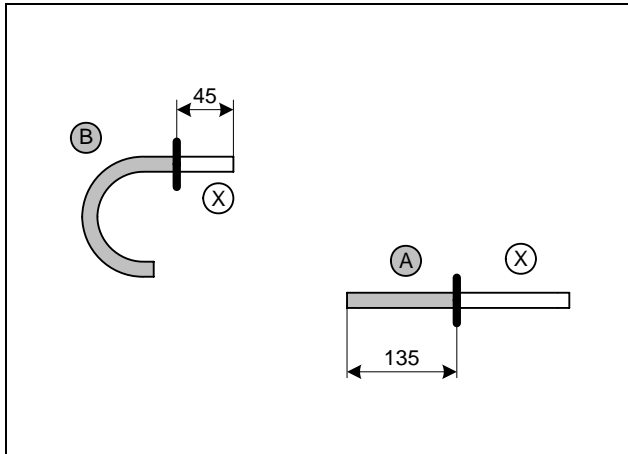
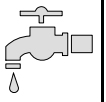

Shorten hose **A** = straight end
 Shorten hose **B** = 180° elbow
 Discard section **X**



Cutting coolant hoses to length

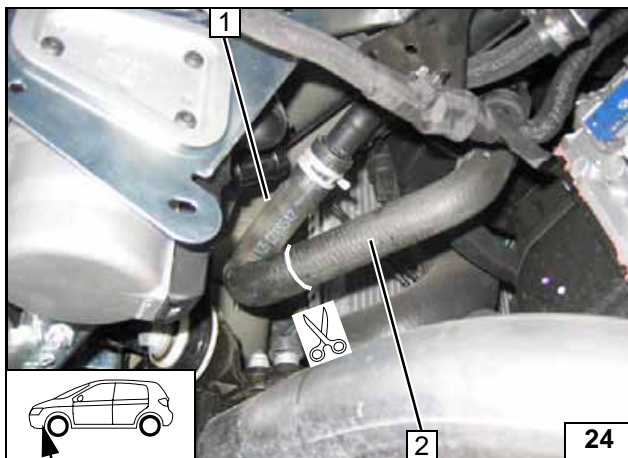

1 Hose section of heat exchanger inlet
 2 Engine outlet hose section

Cutting point

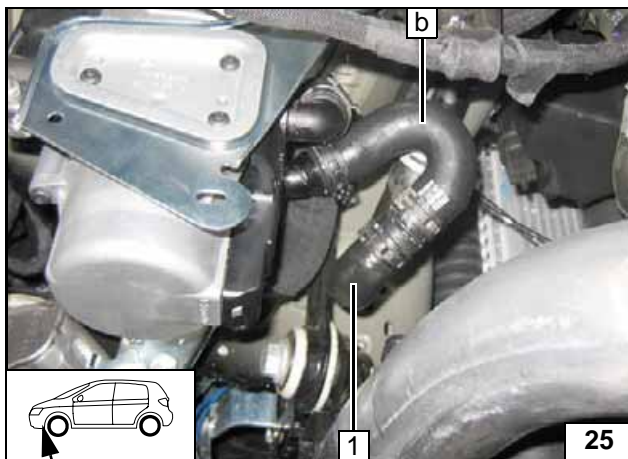

Connect hose **B** with long leg to heater unit outlet.

1 Hose on heat exchanger inlet



Connecting heat exchanger inlet

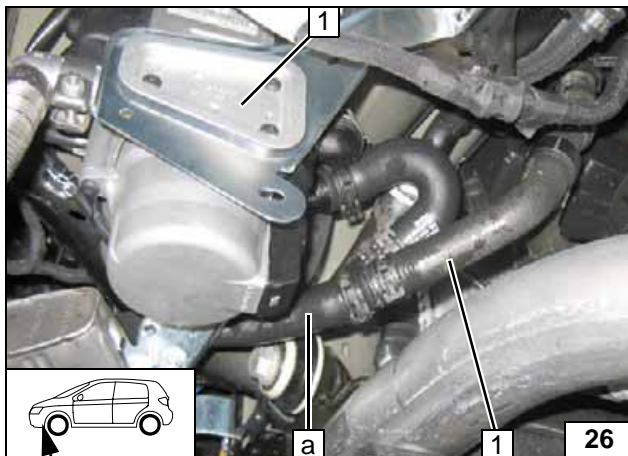

Connect hose **A** on circulating pump inlet.

1 Hose of engine outlet



Connecting engine outlet



Fuel

CAUTION!

Open the vehicle's fuel tank cap, ventilate the tank and then re-close the tank lock.

Catch any fuel running off with an appropriate container.

Install fuel line and metering-pump wiring harness so that they are protected against stone impact. Unless specified otherwise, always fasten using cable ties. Mount the fuel line and wiring harness with rub protection on sharp edges.

WARNING!

The fuel line and wiring harness are routed to the metering pump in as shown in the wiring harness routing diagram.

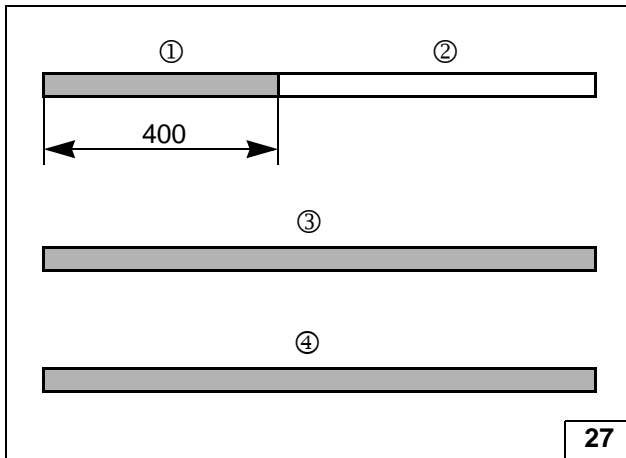

27

Preparing corrugated tube

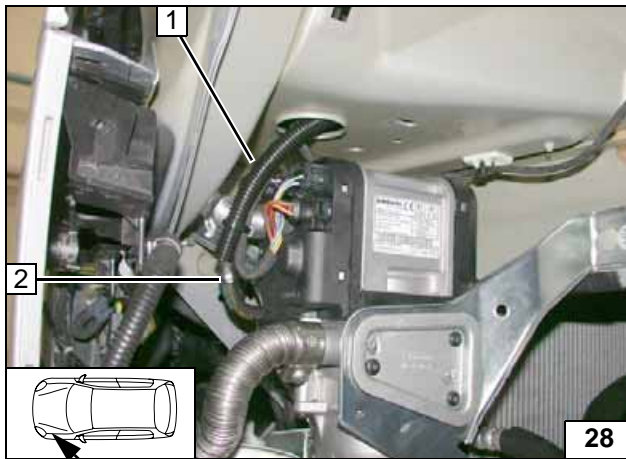

28

Cut approx. 400 mm off first corrugated tube.

- 1 Fuel line in corrugated tube ①
- 2 10 mm dia. Caillau clamp, 90° molded hose



Connecting heater unit

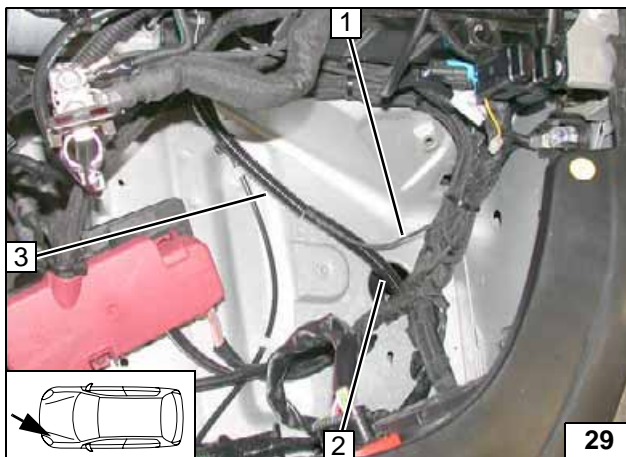

29

- 1 Metering pump wiring harness
- 2 Fuel line in corrugated tube ①
- 3 Fuel line, wiring harness of metering pump in corrugated tube ②

Routing line



1 Fuel line, wiring harness of metering pump in corrugated tube ③

Installing lines

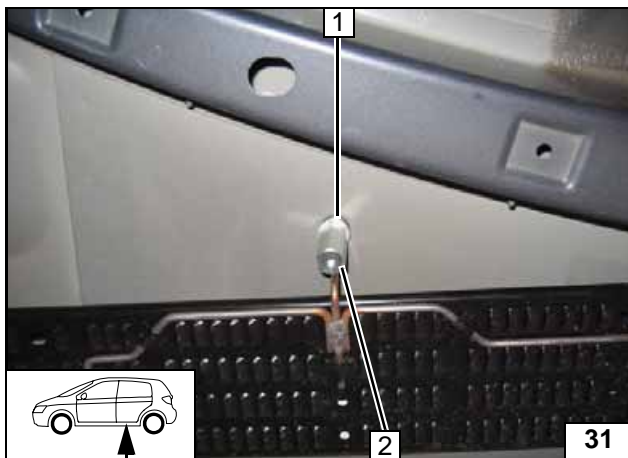

Remove original vehicle nut at position 1 and discard.



2 Large diameter washer, 30 mm spacer nut

Installing metering pump

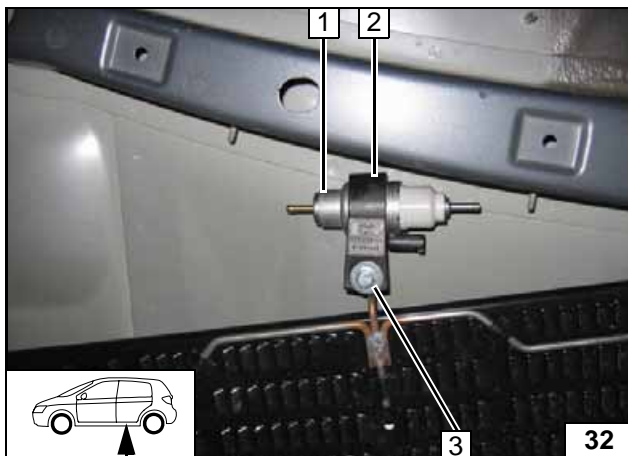

1 Metering pump
2 Bracket of metering pump
3 M6x20 bolt, spring lockwasher, large diameter washer



Installing metering pump

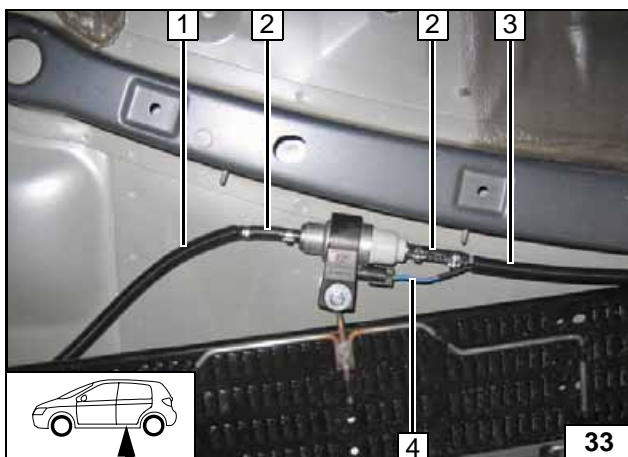

1 Fuel line in corrugated tube ④
2 Hose section [2x], 10 mm dia. Caillau clamp [4x]
3 Fuel line, wiring harness of metering pump in corrugated tube ③
4 Wiring harness of metering pump, connector mounted

Connecting metering pump

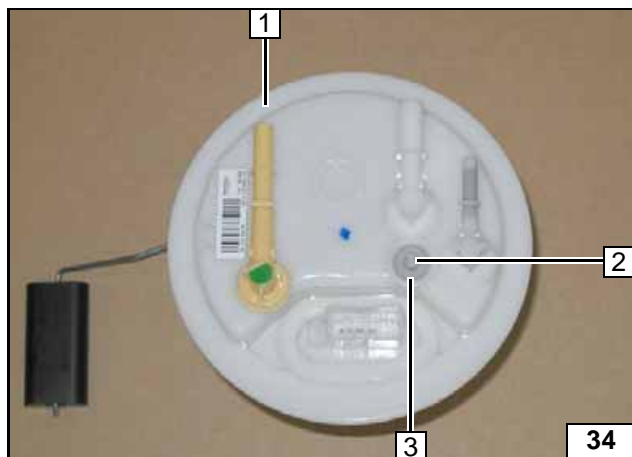
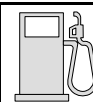

Remove fuel-tank sending unit 1 in accordance with manufacturer's specifications.

- 2 Copy hole pattern, 6 mm dia. hole
- 3 5 mm dia. large diameter washer

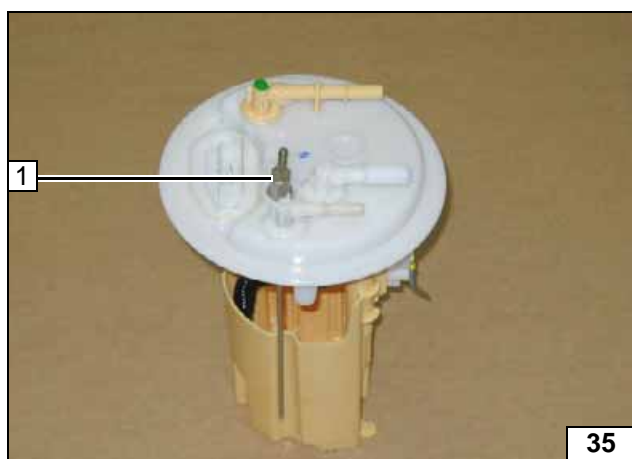

Shape fuel standpipe 1 according to template, cut to length and install.

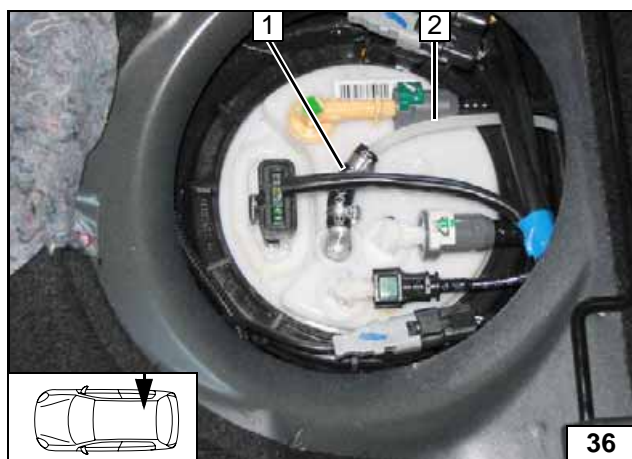

Check the position of the components; adjust if necessary. Check that they have free clearance.
Install fuel-tank sending unit according to manufacturer's specifications.

- 1 Hose section, 10 mm dia. Caillau clamp [2x]
- 2 Fuel line



Removing fuel



Installing fuel standpipe



Connecting fuel line

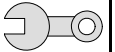

Final Work

WARNING!

Reassemble the disassembled components in reverse order.
 Check all hoses, clamps and all electrical connections for firm seating.
 Secure all loose cables using cable ties.
 Only use manufacturer-approved coolant.
 Spray heater unit components with anti-corrosion wax (Tectyl 100K, Order No. 111329).

- Connect the battery.
- Fill and bleed the coolant circuit according to the vehicle manufacturer's specifications.
- Set the digital timer.
- Code the BSI for the additional heater in accordance with the manufacturer's instructions.
- Check the proper operation of the additional heater, see the operating instructions/installation instructions.
- Attach the "Switch off additional heater before refueling" sticker to the left-hand B-pillar.

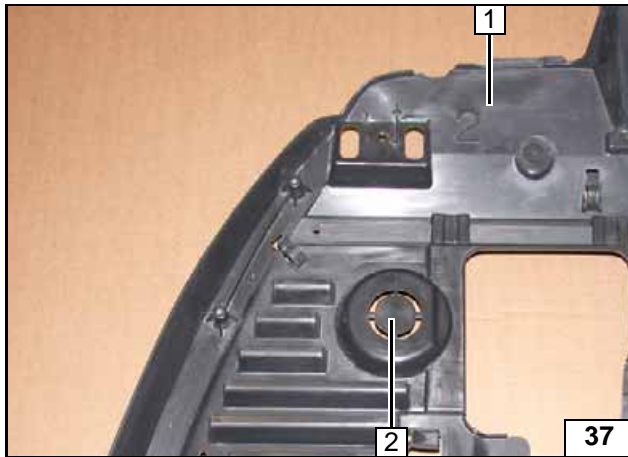

- 1 Underride protection
- 2 Cut out exhaust outlet along perforation

Cutting out underride protection

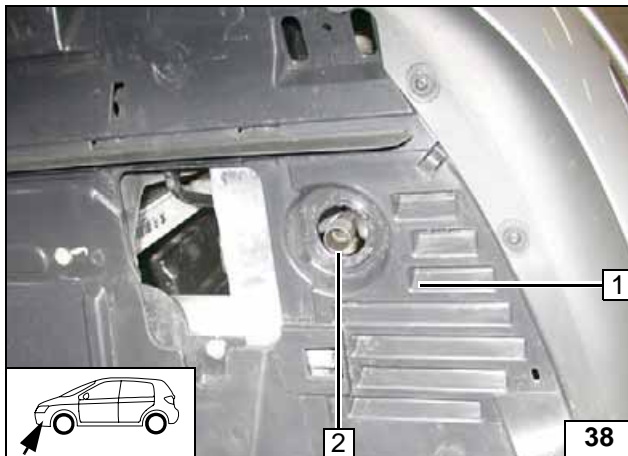

- Align underride protection 1 (exhaust end section centered in cut-out).
- 2 Exhaust end section



Mounting underride protection



Webasto AG
 Postfach 80 - 82132 Stockdorf
 Hotline 01805 / 932278 - Hotfax 0395 / 5592-353
<http://www.webasto.de>



Template for Fuel Standpipe



100 mm



Scale 1:1

Compare the size of the printed version with dimension lines.

Permitted tolerance a maximum of 2%.

Set the printer settings to "no margin" or "minimize margins" and 100% of the normal size.

100 mm

0