

Water Heater



Thermo Top E Parking Heater

00 0003

Thermo Top C Parking Heater

00 0002

Thermo Top P Parking Heater

00 0104

Installation documentation

Citroen Berlingo / Peugeot Partner

Petrol

from Model Year 2008

Left-hand drive vehicle

Manual transmission



WARNING!

Hazard warning:

Incorrect installation or repair of Webasto heating systems may cause a fire or result in the emission of carbon monoxide, which can be fatal. Serious or fatal injuries can be caused as a result.



Specialist company training, technical documentation, specialised tools and equipment are required to install and repair Webasto heating and cooling systems. Only original Webasto parts must be used. For this, also see the catalog of air and water heater accessories from Webasto.

NEVER attempt to install or repair Webasto heating or cooling systems if you have not successfully completed the company training and thereby acquired the required technical skills, or if you do not have access to the required technical documentation, tools and equipment needed to carry out correct installation and repairs.

ALWAYS follow all Webasto installation and repair instructions and observe all warnings.

The initial startup is to be executed with the Webasto Thermo Test Diagnosis.

Webasto does not accept any liability for defects and damage that are attributable to installation by untrained staff.

Table of Contents

| | | | |
|--|----|---|----|
| Validity | 2 | Preparing bracket | 13 |
| Heater/Installation Kit | 3 | Installing bracket | 14 |
| Foreword | 3 | Installing heater | 14 |
| General Instructions | 3 | Fuel | 18 |
| Special Tools | 3 | Exhaust gas | 21 |
| Explanatory Notes on Document | 4 | Combustion air | 23 |
| Preliminary Work | 5 | Final Work | 24 |
| Heater installation location | 5 | Template for Fuel Standpipe | 25 |
| Preparing electrical system | 6 | Operating Instructions for End Customer | 26 |
| Electrical system | 7 | | |
| Fan controller for manual air conditioning | 8 | | |
| Automatic air-conditioning fan controller | 10 | | |
| Digital timer, summer/winter switch option | 12 | | |
| Remote option (Telestart) | 12 | | |

Validity

| Manufacturer | Model | Type | EG-BE No./ABE |
|--------------|----------|------|----------------------------|
| Citroen | Berlingo | 7 | e1 * 2001/116 * 0366 * ... |
| Peugeot | Partner | 7 | e2 * 2001/116 * 0365 * ... |

| Engine type | Engine model | Output in kW | Displacement in cm ³ |
|-------------|--------------|--------------|---------------------------------|
| NFU | Petrol | 80 | 1587 |
| 5FS | Petrol | 88 | 1598 |

Vehicle and engine types, equipment variants and national specifications not listed in this installation documentation have not been tested. However, installation according to this installation documentation may be possible.

The installation location of a digital timer and summer/winter switch should be confirmed with the end customer before installation.

Heater/Installation Kit

| Quantity | Description | Order No.: |
|----------|---|----------------|
| 1 | Retail accessories with desired heater control | See price list |
| 1 | Installation Kit for PSA Berlingo/Partner Petrol manual air conditioning | 1313670D |
| or | | |
| 1 | Installation Kit for PSA Berlingo/Partner Petrol Automatic Air-Conditioning | 1313671D |

Heater recommended for the respective vehicle class:

| Vehicle | Heater |
|-------------------------------|--------------|
| Compact car | Thermo Top E |
| Mid-size car, station wagon | Thermo Top C |
| Full-size car, van, offroader | Thermo Top P |

The selection of the heater is based on the passenger compartment size of the vehicle and the level of comfort required by the customer!

Foreword

This installation documentation is applicable to Citroen Berlingo / Peugeot Partner Petrol vehicles - For the validity, see Page 2 - from model year 2008 and later, assuming technical modifications to the vehicle do not affect installation, any liability claims excluded. Depending on the vehicle version and equipment, modifications may be necessary during installation with respect to this installation documentation.

However, the stipulations in this "installation documentation", the "operating instructions" and "installation instructions" for the *Thermo Top E/C/P* must always be observed.

The corresponding rules of technology and any information from the vehicle manufacturer should be observed during the installation work.

General Instructions

Installation should be carried out according to the general, standard rules of technology. Unless specified otherwise, fasten hoses, lines and wiring harnesses to original vehicle lines and wiring harnesses using cable ties.

Sharp edges should be fitted with rub protection (split-open fuel hose).

Spray unfinished body areas, e.g. drilled holes, with anti-corrosion wax (Tectyl 100K, Order No. 111329). When installing an IPCU, the corresponding settings must be checked or adjusted before the installation.

Special Tools

- Torque wrench for 2.0 - 10 Nm
- Hose clamping pliers
- Metric thread-setter kit

Explanatory Notes on Document

To provide you with a quick overview of the individual working steps, you will find an identification mark on the outside top right corner of the page in question.

Mechanical system

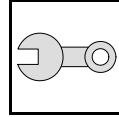

Electrical system

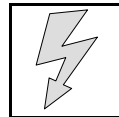

Coolant circuit

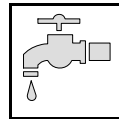

Fuel

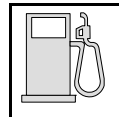

Exhaust gas

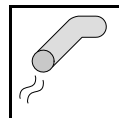

Combustion air

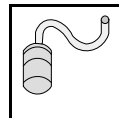

Special features are highlighted using the following symbols:



Specific risk of injury or fatal accidents.



Specific risk of damage to components.



Specific risk of fire or explosion.



Reference to general installation instructions of Webasto components or to the manufacturer's vehicle-specific documents.



Reference to a special technical feature.

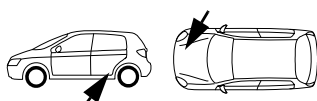

The arrow in the vehicle icon indicates the position on the vehicle and the viewing angle.

All dimensions are in mm!

Tightening torque of hose clamps = 2.0 + 0.5 Nm!

Tightening torque of Ejet screws, Ejet studs = 10 Nm!

Preliminary Work

WARNING!

- Disconnect the battery "earth" or "ground" connection.
- Depressurize the cooling system.
- Copy the factory number from the original type label to the duplicate type label.
- Remove years that do not apply from the duplicate label.
- Attach the duplicate label (type label) in the appropriate place.
- Open the fuel tank cap and vent the fuel tank.
- Close the fuel tank cap again.
- Remove the engine cover (depending on the vehicle equipment, if installed)
- Remove the air filter box with the intake hose and the resonator.
- Remove the bracket for the resonator.
- Completely remove the battery and the battery carrier.
- Remove the exhaust system (only on gasoline vehicles).
- Lower the fuel tank (wait until working on: fuel).
- Remove the left front wheel.
- Remove the left-hand wheel well trim.
- Remove the lower instrument panel trim on the driver's and front passenger side
- Remove the glove compartment.

Remove page 26 "Operating Instructions for End Customer" and add to the vehicle operating instructions.

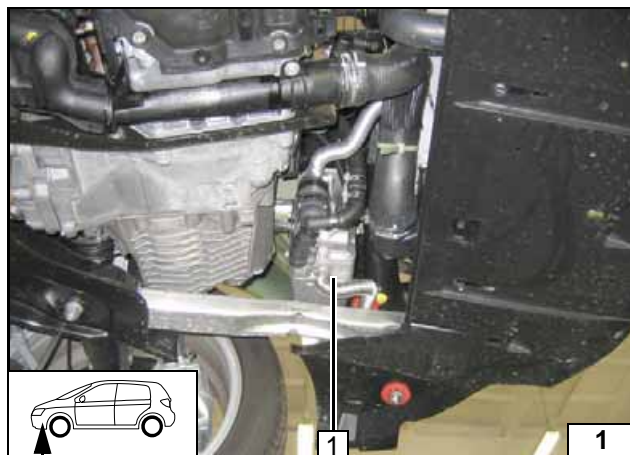

Heater installation location

1 Heater

Installation location



Preparing electrical system

Manual air conditioning

Cut one end of 0.75² brown (br) wire, to approx. 80 mm.
Produce connections as shown in wiring diagram.

- 1 Red (rt) wire, 0.75² - 1000
- 2 Black (sw) wire, 4² - 1000
- 3 Blue (bl) wire, 1.5² - 300
- 4 Brown (br) wire, 4² - 1000
- 5 Brown (br) wire, 0.75² - 80

Automatic air-conditioning

Produce connections as shown in wiring diagram. Uncrimp green/white (gn/ws) wire from K3/87a and connect together with wire section 1 to K3/86.

Connect wires to IPCU (IPCU view on contact side).
Pull wire 5 into the protective sleeving provided and route to OBD socket outlet.

- 2 Brown (br) wire, 0.75² - 500
- 3 Black (sw) wire, 0.75² - 500
- 4 Red (rt) wire, 0.75² - 500
- 5 Red (rt) wire, 0.75² - 2000

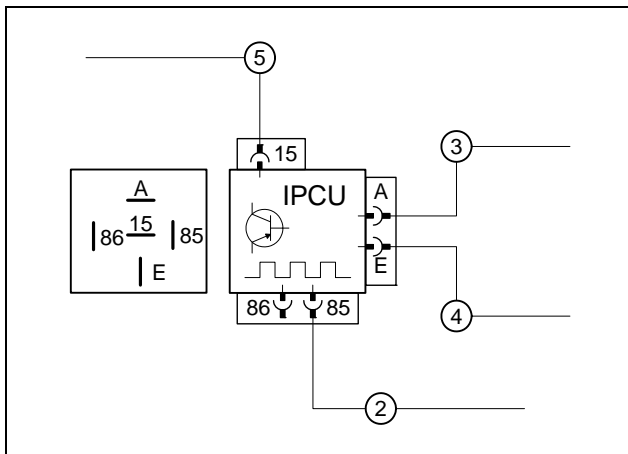
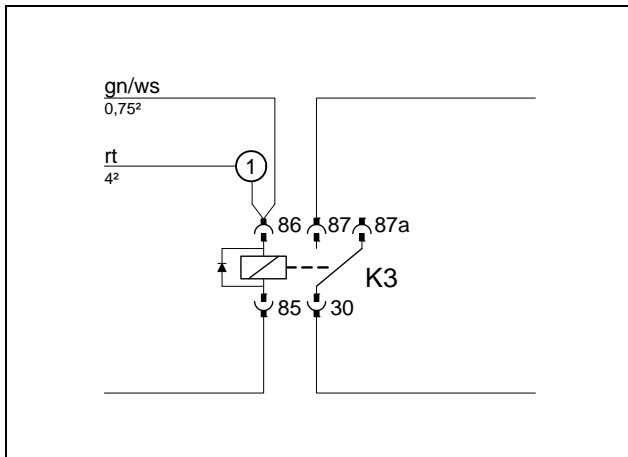
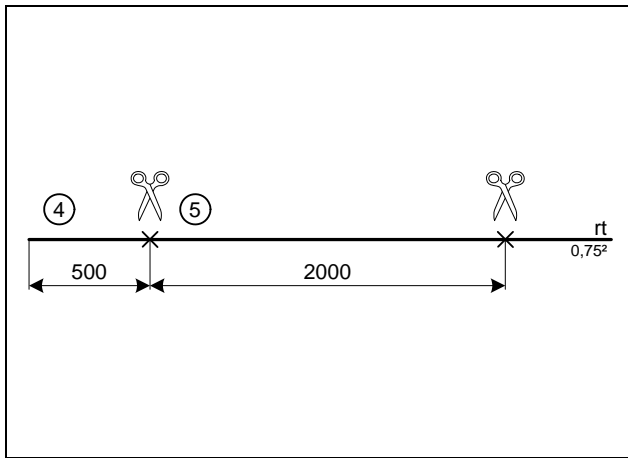
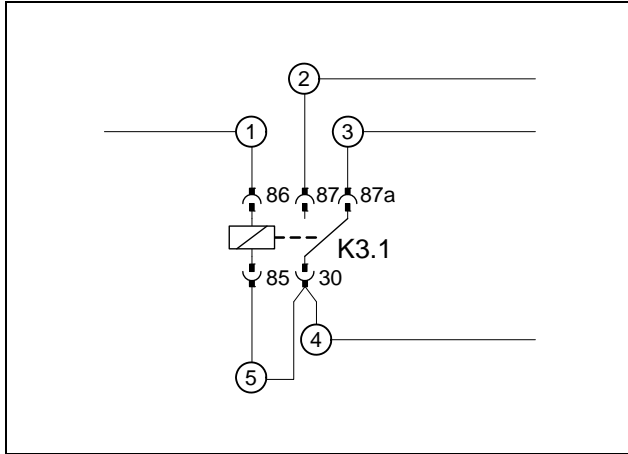

Preparing additional relay K3.1



Cutting red (rt) wire, 0.75² to length



Preparing K3 relay



Premounting IPCU



Electrical system

Connecting positive wire

Before installing, crimp 8 mm dia. cable lug onto positive wire.

- 1 Red (rt) wire
- 2 Original vehicle positive support point (10 Nm)

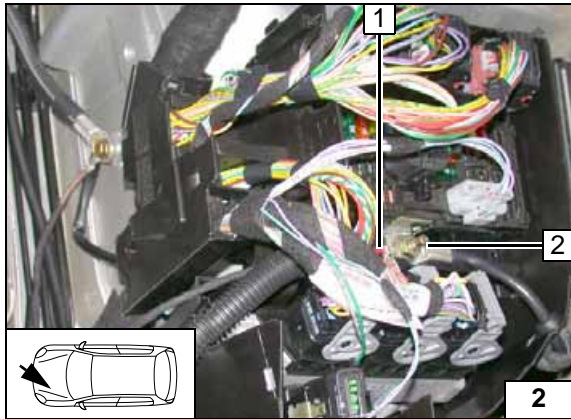

Wiring harness pass through

Route wiring harnesses (digital timer, fan controller and red (rt) wire in protective sleeving) on original vehicle wiring harness 1 to protective rubber plug 2 and route into passenger compartment.

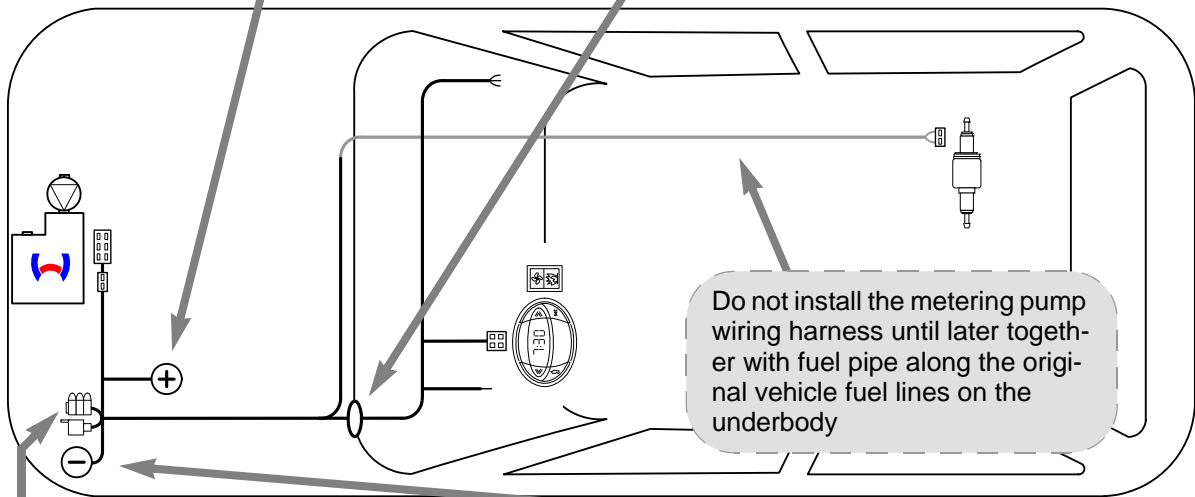
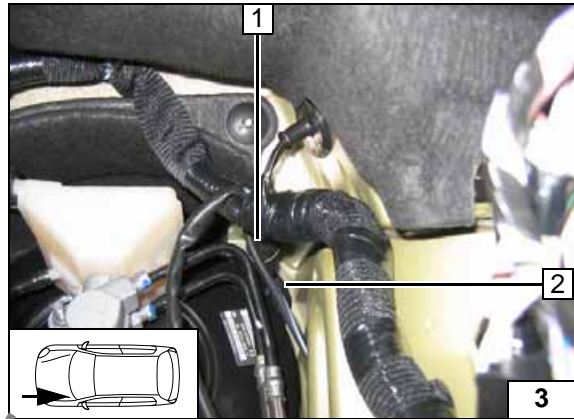

Wiring harness routing diagram

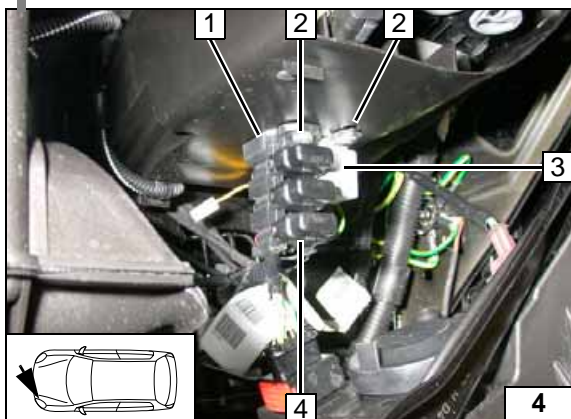

Fuse holder, K3 relay

- 1 Retaining plate for fuse holder
- 2 4 mm dia. hole, 5.5x13 self-tapping screw; plastic nut [2x each]
- 3 K3 relay
- 4 Fuse holder

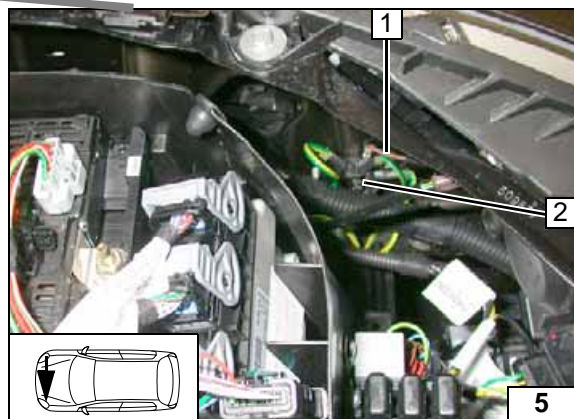

Connecting earth wire

- 1 Brown (br) wire
- 2 Original vehicle earth support point



Fan controller for manual air conditioning

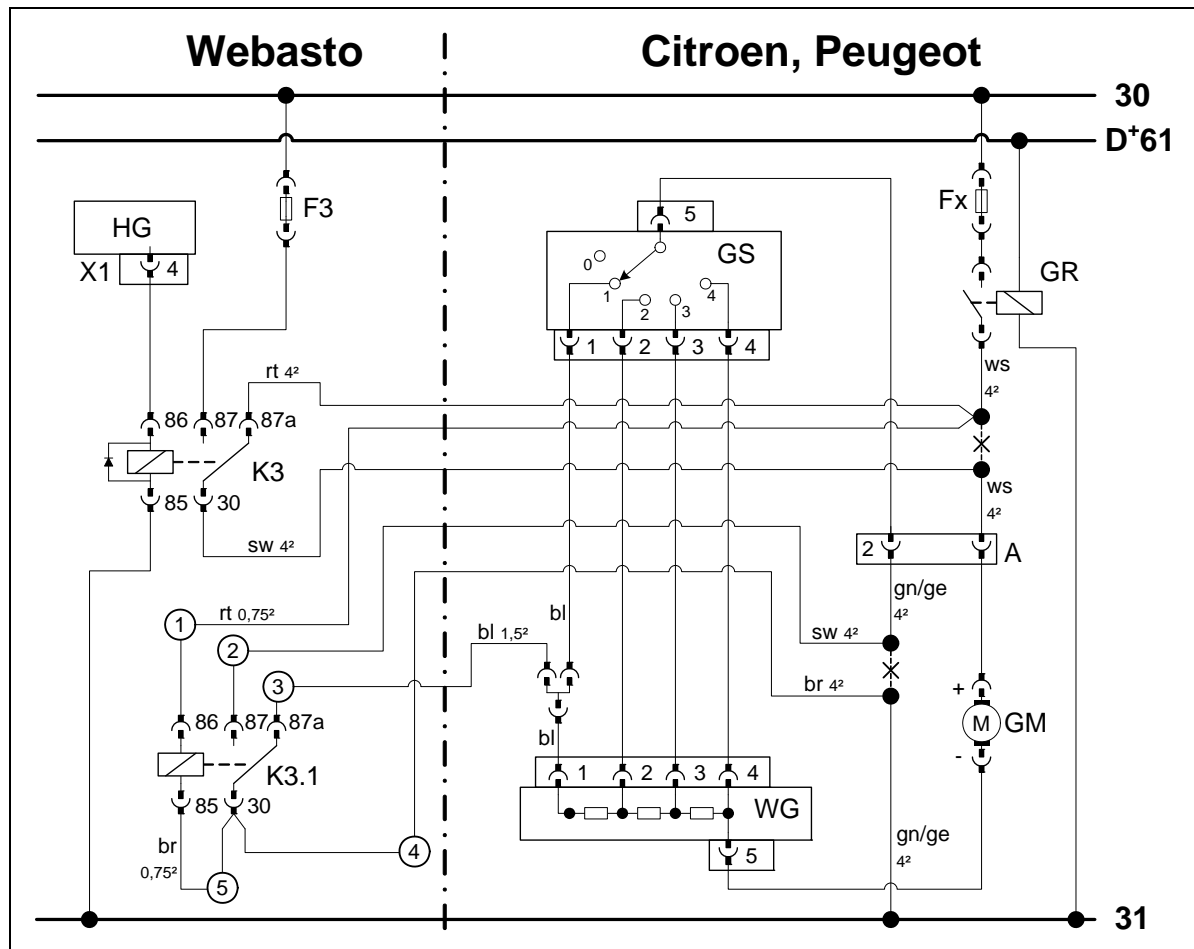

Wiring diagram

| Webasto components | | Vehicle components | | Colours and symbols | |
|--------------------|------------------------|--------------------|-----------------|--------------------------|---------------|
| HG | Heater TT-C/E | GM | Fan motor | rt | red |
| X1 | 6-pin heater connector | GRs | Fan relay | ws | white |
| F3 | 25 A fuse | GS | Fan switch | sw | black |
| K3 | Fan relay | WG | Resistor group | br | brown |
| K3.1 | Additional relay | a | 6-pin connector | bl | blue |
| | | Fx | Fuse | bl | blue |
| | | | | | |
| | | | | X | Cutting point |
| | | | | Wiring colours may vary. | |

Legend

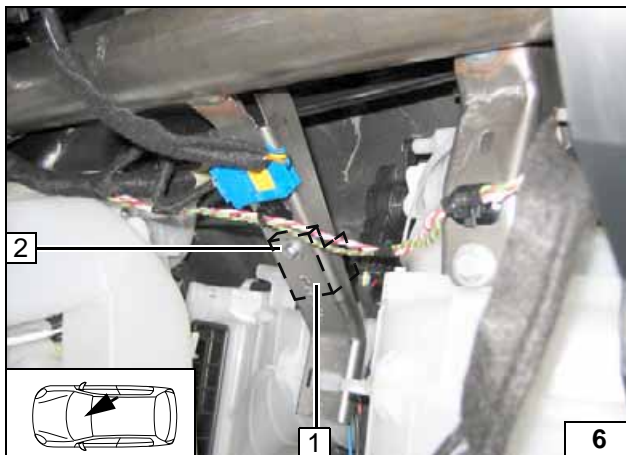

- 1 K3.1 relay covered (installed behind original vehicle strut)
- 2 M5x16 bolt, large diameter washer, flanged nut

Installing K3.1 relay

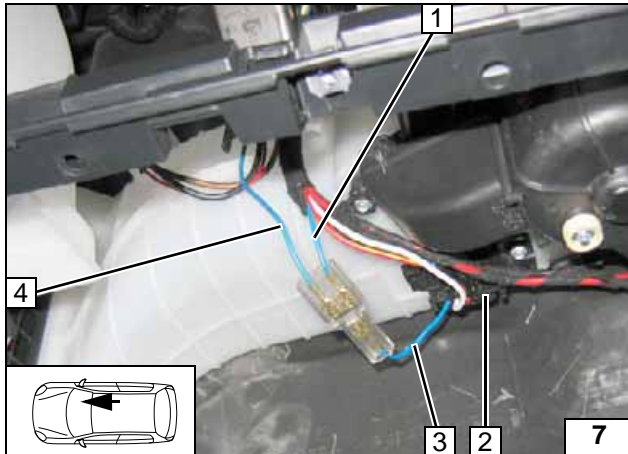

Connection to 5-pin connector **2** from resistor group.
Produce connections as shown in wiring diagram.

- 1 Blue (bl) wire of fan switch
- 3 Blue (bl) wire of connector, Pin 1, disconnected
- 4 Blue (bl) wire to K3.1/87a



Connecting resistor group

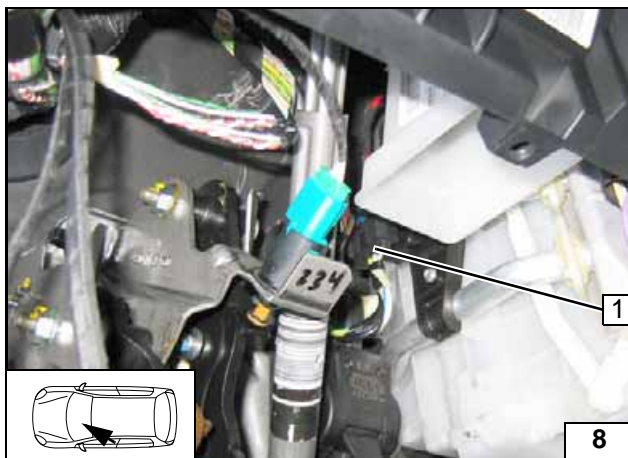

Connection on 6-pin connector A!

Disconnecting connector A

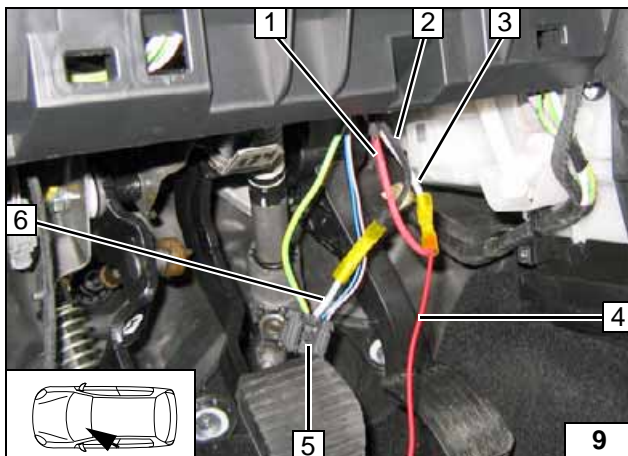

Connection on 6-pin connector A **5**.
Produce connections as shown in wiring diagram.

- 1 Red (rt) wire from K3/87a
- 2 Black (sw) wire from K3/30
- 3 White (ws) wire of fan relay
- 4 Red (rt) wire to K3.1/86
- 6 White (ws) wire 6-pin connector A



Connecting fan-motor

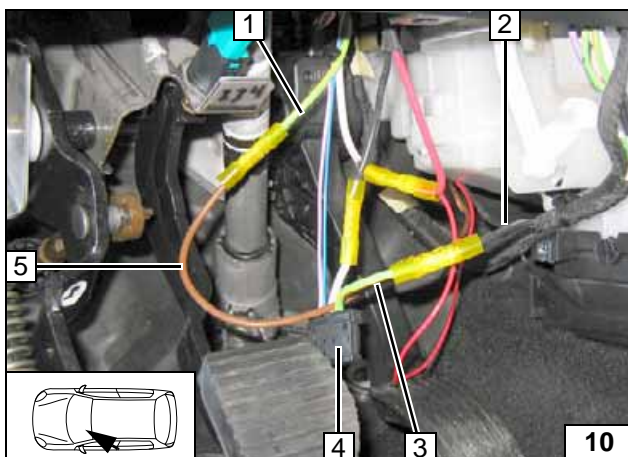

Connection on 6-pin connector A **4**.
Produce connections as shown in wiring diagram.

- 1 Green/yellow (gn/ge) wire of earth wire
- 2 Black (sw) wire K3.1/87
- 3 Green/yellow (gn/ge) wire of 6-pin connector A
- 5 Brown (br) wire K3.1/30



Connecting fan switch



Automatic air-conditioning fan controller

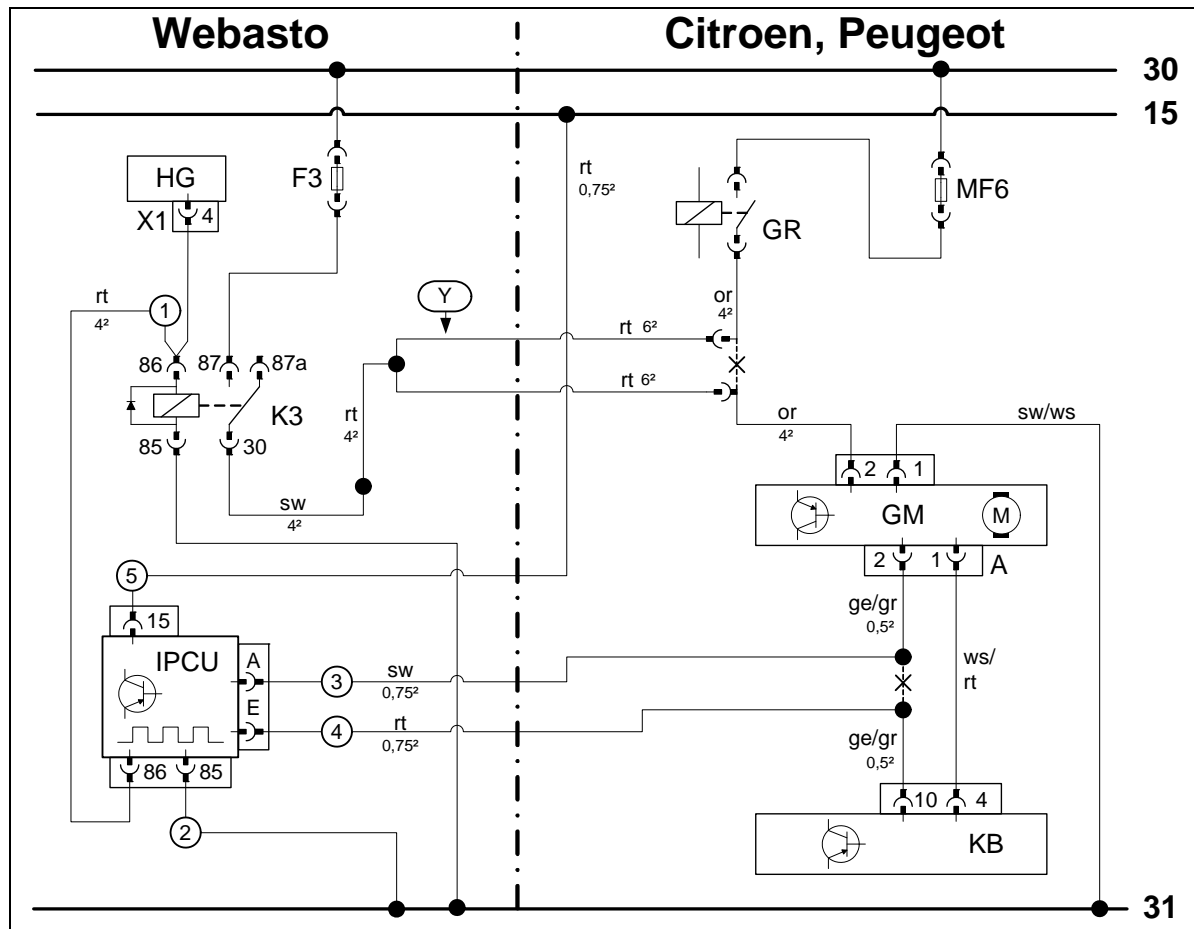

Wiring diagram

| Webasto components | | Vehicle components | | Colours and symbols | |
|--------------------------------|------------------------|--------------------|---|--------------------------|---------------|
| HG | Heater TT-C/E | KB | A/C control unit | rt | red |
| X1 | 6-pin heater connector | GR | Fan relay | ws | white |
| F3 | 25 A fuse | GM | Fan module | sw | black |
| K3 | Fan relay | a | 2-pin connector GM | ge | yellow |
| IPCU | Pulse width modulator | MF6 | Fuse | gr | gray |
| Y | Wiring adapter | Ter. 15 | Measure (e.g., 16-pin OBD socket outlet, Pin 1) | or | orange |
| IPCU adjustment values: | | | | | |
| Duty cycle: 42% | | | | | |
| Frequency: 1000Hz | | | | | |
| Voltage: 5V | | | | | |
| Function: High-side | | | | X | Cutting point |
| | | | | Wiring colours may vary. | |

Legend

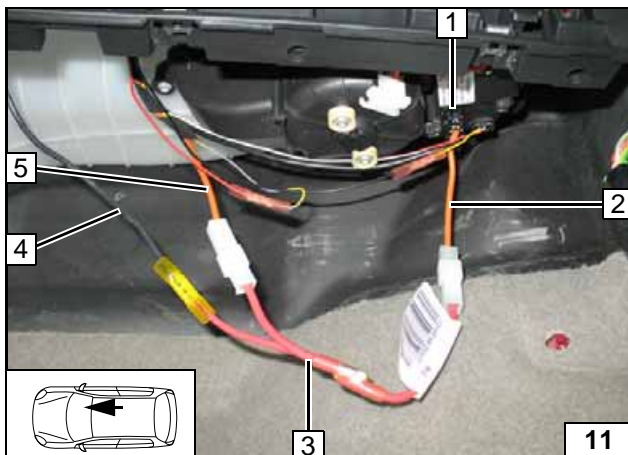

Fan motor is controlled on 2-pin connector A 1 of fan module. Produce connections as shown in wiring diagram.

- 2 Orange (or) wire of connector A, Pin 2
- 3 Y-adapter
- 4 Black (sw) wire from K3/30
- 5 Orange (or) wire of GR

Connection to fan module

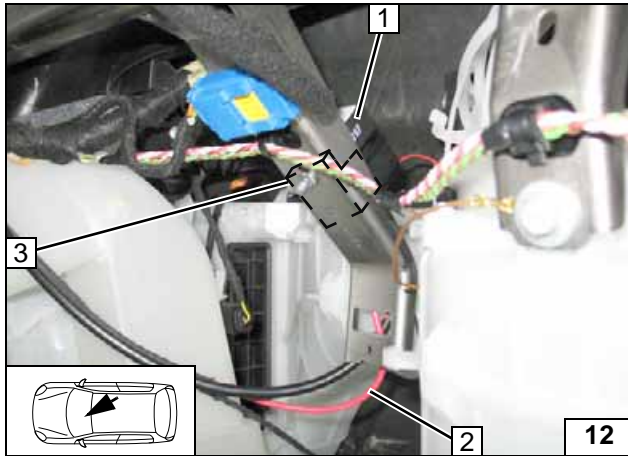

Before installing, connect red (rt) wire **2** from K3/86 to socket of IPCU terminal 86.

- 1** IPCU covered (installed behind original vehicle strut)
- 3** M5x16 bolt, large diameter washer, flanged nut



Installing IPCU

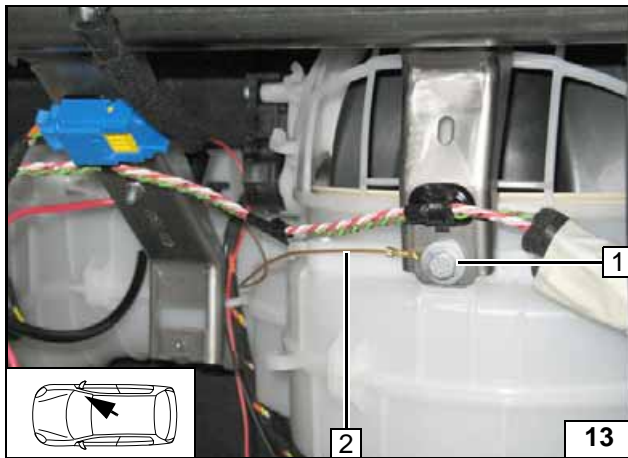

- 1** Original vehicle bolt
- 2** Brown (br) wire of IPCU/85, cable lug

Connecting IPCU

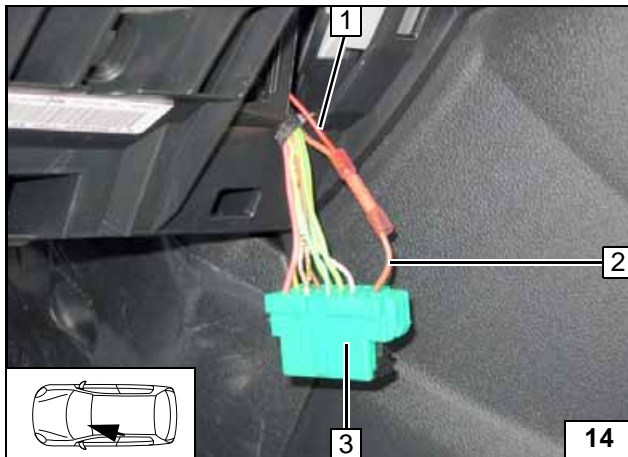

- 1** Red (rt) wire IPCU/15
- 2** Brown (br) wire of terminal 15 of OBD socket outlet, Pin1
- 3** OBD socket outlet disconnected

Connecting IPCU

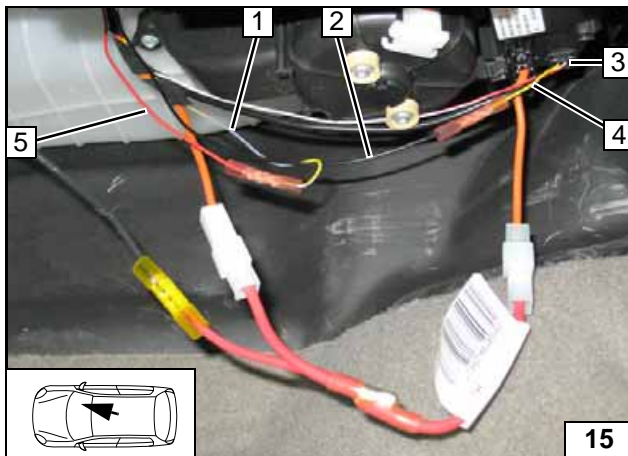

Fan controller is controlled before 2-pin connector **3** of fan module. Produce connections as shown in wiring diagram.

- 1** Yellow/gray (ge/gr) wire on connector of A/C control panel
- 2** Black (sw) wire of IPCU/A
- 4** Yellow/gray (ge/gr) wire of connector 2V NR, Pin 2
- 5** Red (rt) wire of IPCU/E



Connecting fan controller

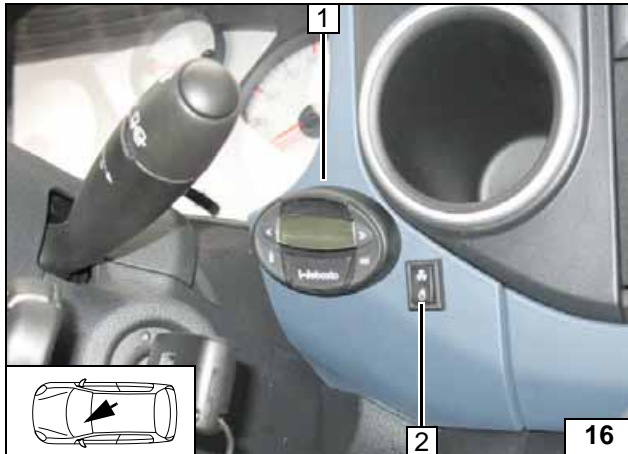

Digital timer, summer/winter switch option

Installation location shown is a recommendation. Agree upon with end customer before installing.

- 1 Digital timer
- 2 12 mm dia. hole, summer/winter switch

Installing digital timer



Remote option (Telestart)

Fasten receiver 1 with double-sided adhesive tape.

Installing receiver

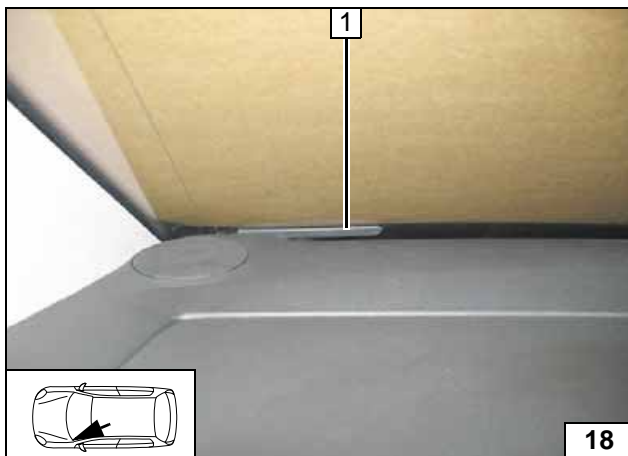

- 1 Antenna

Installing antenna

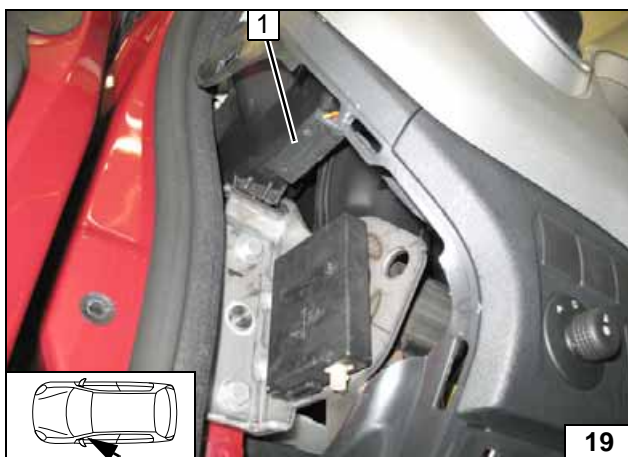

Temperature sensor only for T100 HTM

- 1 Fasten temperature sensor with adhesive tape

Installing temperature sensor



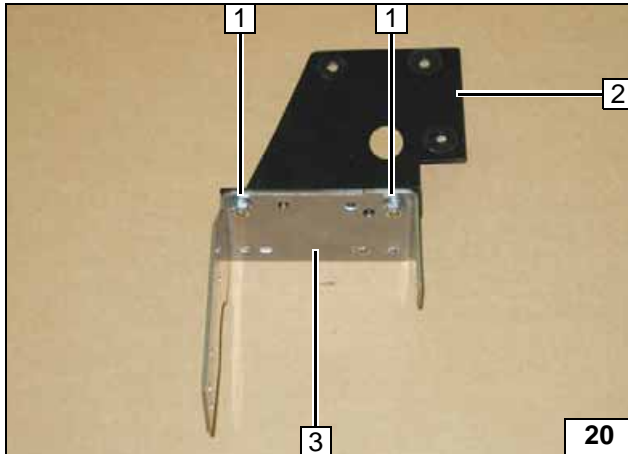
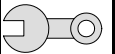

Preparing bracket

- 1 M6x12 bolt, flanged nut [2x each]
- 2 Bracket A
- 3 Bracket B

Preparing bracket

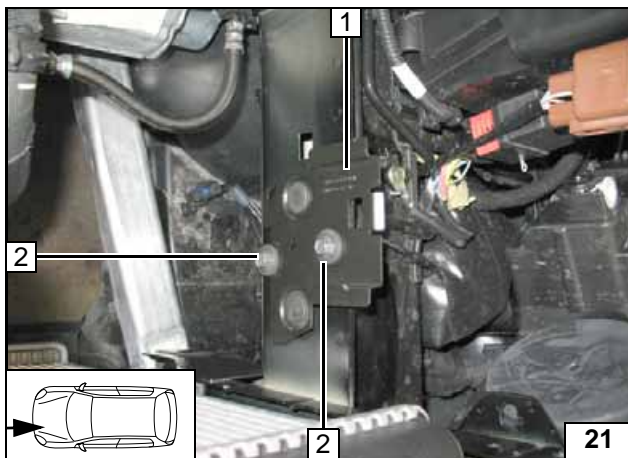

Preparing installation location

Dismantle bracket resonator 1. Original vehicle bolts at position 2 will be reused.



Dismantling bracket

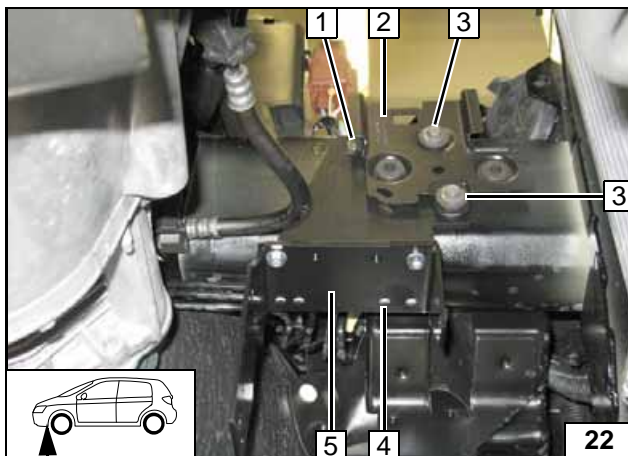

Install premounted brackets (A and B) 5 together with resonator bracket 2 loosely.

- 1 M6x20 bolt, spring lockwasher, large diameter washer
- 3 Original vehicle bolt [2x]
- 4 Transfer hole pattern to frame side member



Installing bracket loosely

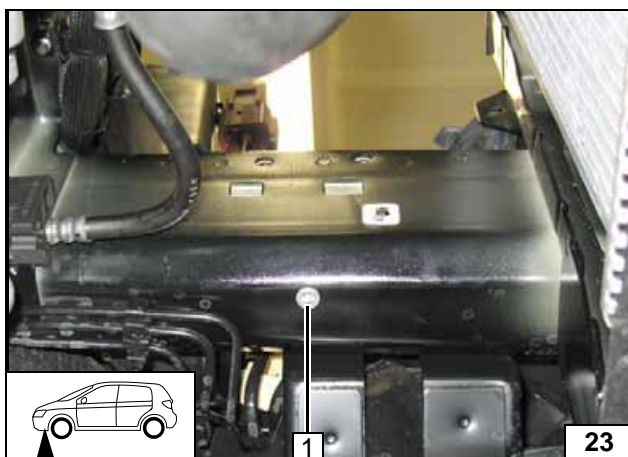

Dismantling bracket

- 1 Drill 9.1 mm dia. hole; rivet nut



Installing rivet nut

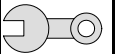

Cut off tab 1 from resonator at the marking.



Preparing resonator

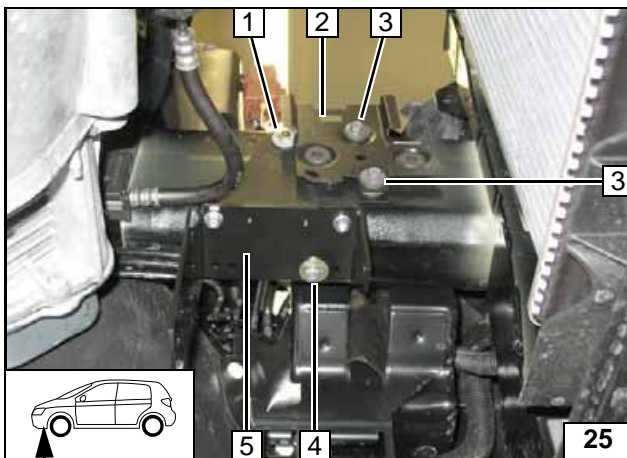

Installing bracket

Install premounted brackets (A and B) 5 together with resonator bracket 2.



Installing bracket

- 1 M6x20 bolt, spring lockwasher, large diameter washer
- 3 Original vehicle bolt [2x]
- 4 M6x40 bolt, spring lockwasher, large diameter washer, 20mm shim

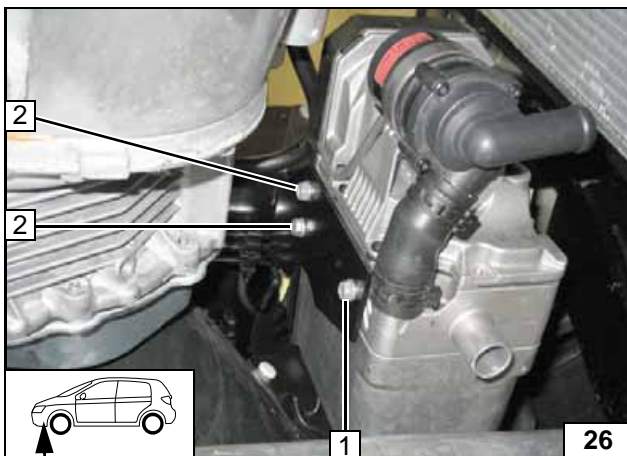

Installing heater

Insert two washers between heater and bracket at Position 1.



Installing heater

- 1 Ejet screw, washer [2x]
- 2 Ejet screw [2x]

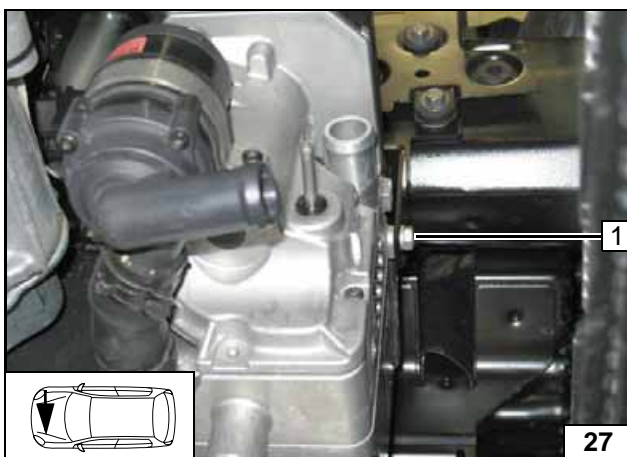

- 1 Ejet screw

Installing heater





Coolant circuit

WARNING!

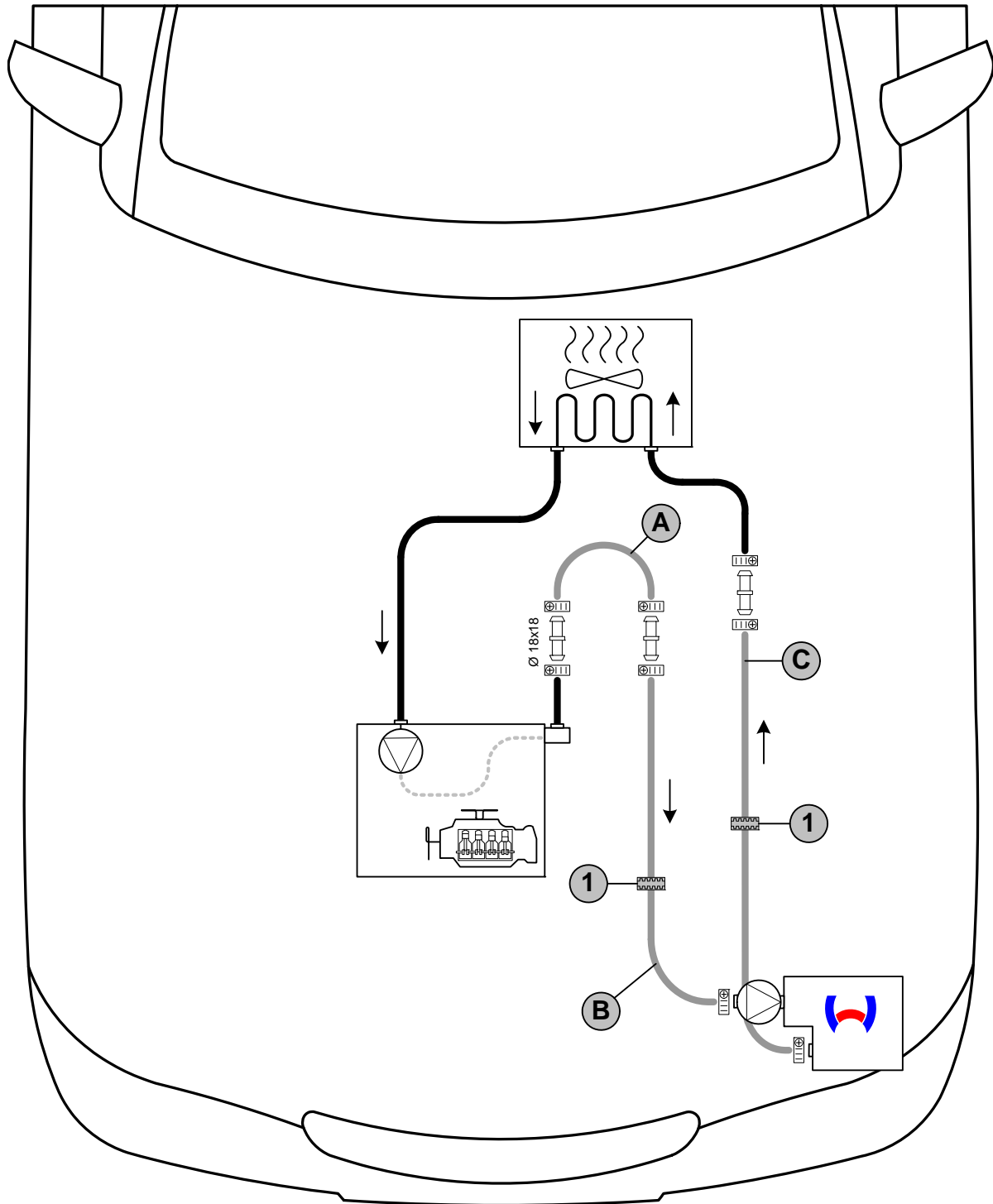
Any coolant running off should be collected using an appropriate container. Route coolant hoses kink-free. Unless specified otherwise, always fasten using cable ties. Position clamps so that other hoses cannot be damaged. When installing the hoses, the heater must be filled with coolant. The connection should be "inline" based on the following diagram:



Hose routing diagram

All hose clamps  = 20-27 mm dia. All connecting pipes without a specific designation  = dia. 18x20.
 1 = Black (sw) rubber isolator .



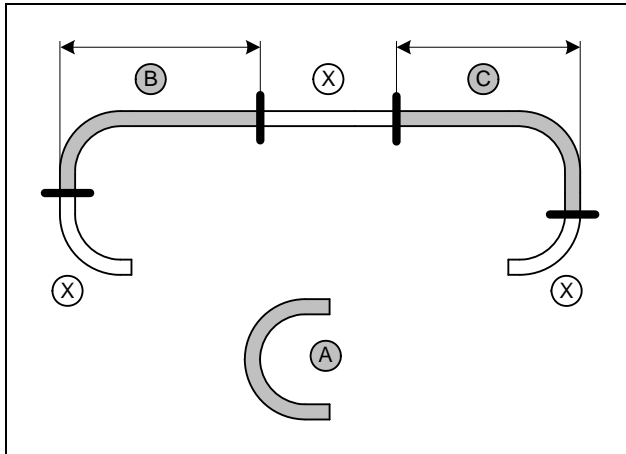
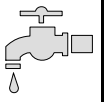

Hose **A** = 180° moulded hose
Discard section **X**.

B = 770
C = 620



Cutting hoses to length

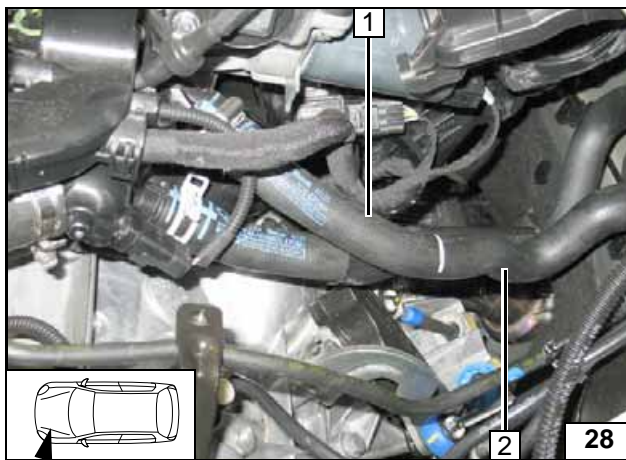

Cut off original vehicle hose on engine outlet/heat exchanger inlet at marking. Remove original vehicle braided protection hose, if available.

- 1 Engine outlet hose section
- 2 Hose section of heat exchanger inlet



Cutting point

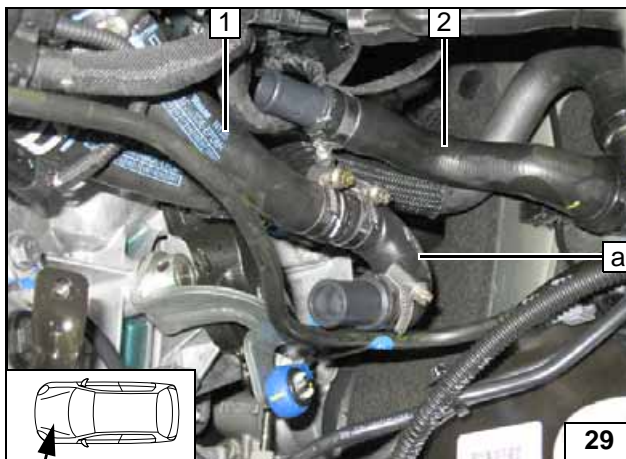

- 1 Engine outlet hose section
- 2 Hose section of heat exchanger inlet

Installing hose A

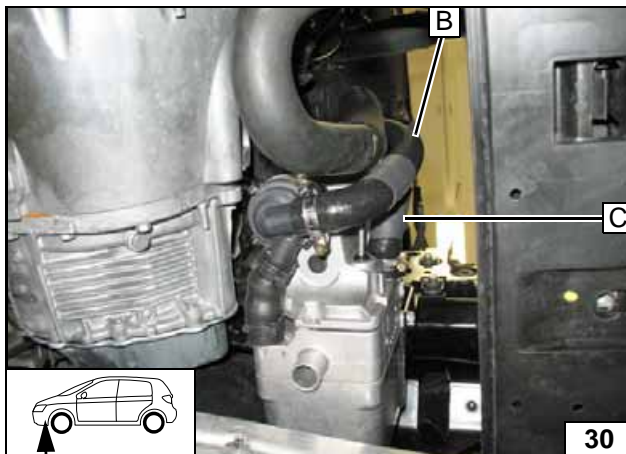

Connecting heater

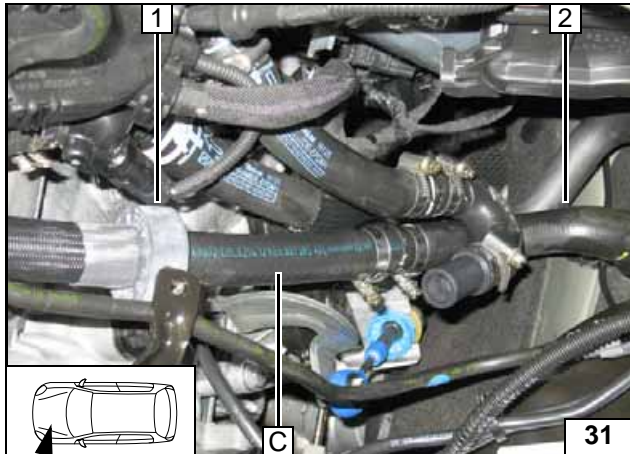

- 1 Push black (sw) rubber isolator onto hose C.
- 2 Hose on heat exchanger inlet

Connect-
ing heat
exchanger
inlet

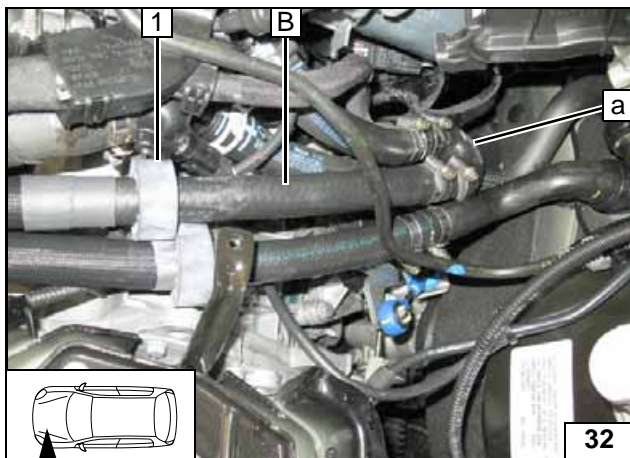

- 1 Slide on black (sw) rubber isolator

Connect-
ing engine
outlet

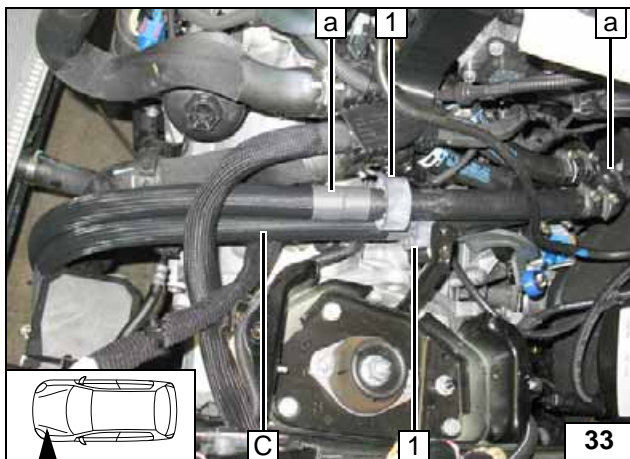

Align and position black (sw) rubber isolator 1 [2x]. Ensure sufficient distance to neighbouring components.



Aligning
hoses

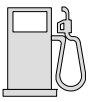

Fuel

CAUTION!

Open the vehicle's fuel tank cap, ventilate the tank and then re-close the tank lock.

Catch any fuel running off in an appropriate container.

Install fuel line and metering pump wiring harness so that they are protected against stone impact. Unless specified otherwise, always fasten using cable ties. Mount the fuel line and wiring harness with rub protection on sharp edges.

WARNING!

The fuel line and wiring harness are routed to the metering pump as shown in the wiring harness routing diagram.

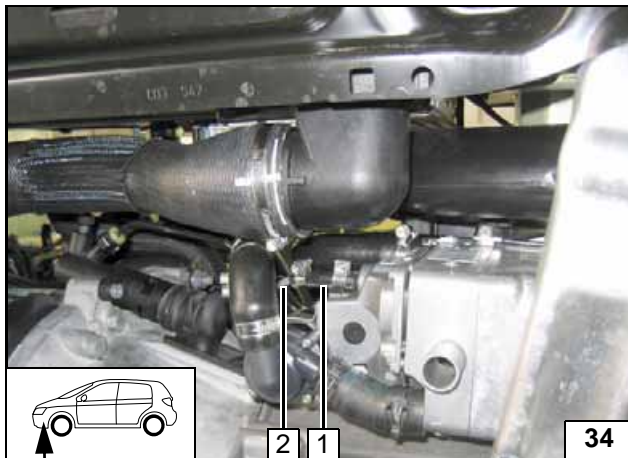

- 1 Hose section, 10 mm dia. clamp [2x]
- 2 Fuel line in corrugated tube

Connection to heater

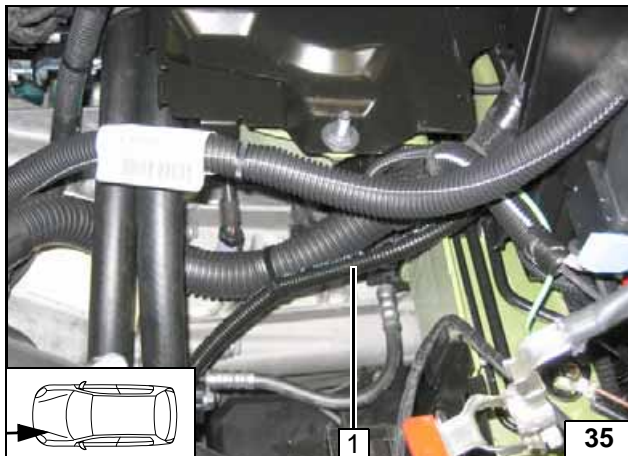

Route fuel line, wiring harness of metering pump in corrugated tube **1** to firewall at right side of vehicle and further to the installation location of the metering pump in the line duct in the underbody.



Installing lines



- 1 Fuel line of Heater
- 2 Line duct
- 3 Metering pump wiring harness

Installing lines

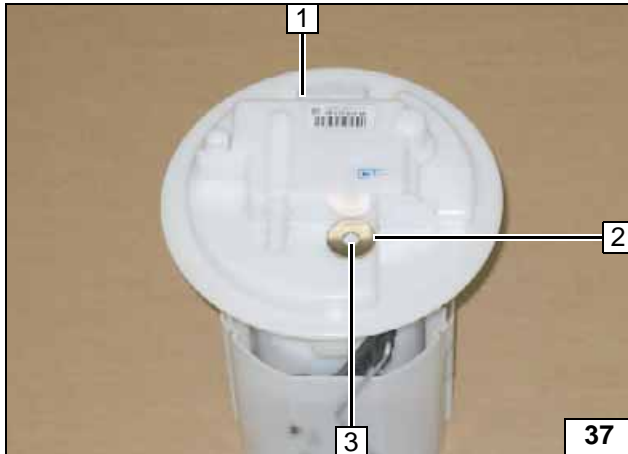

Lower fuel tank and fuel-tank sending unit **1** according to manufacturer's instructions.

- 2** Large diameter washer
- 3** Copy hole pattern, 6 mm dia. hole



Removing fuel

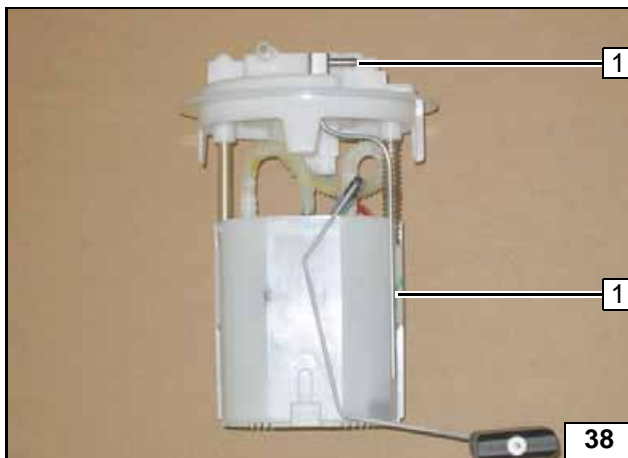

Shape fuel standpipe **1** according to template, cut to length and install.



Installing fuel standpipe

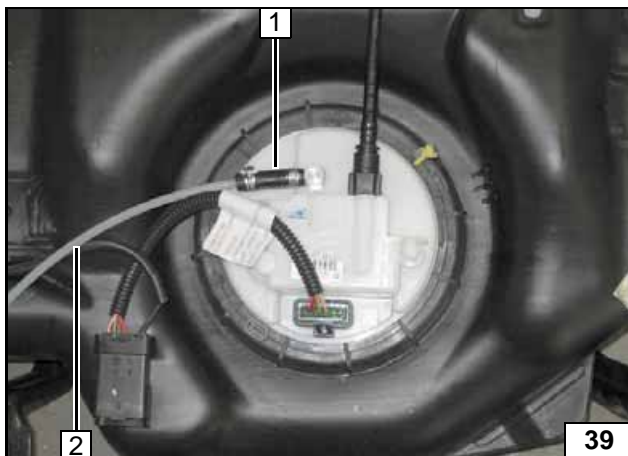

Fuel tank removed for improved depiction. Install fuel-tank sending unit according to manufacturer's instructions. Install fuel tank in accordance with manufacturer's instructions.

- 1** Hose section, 10 mm dia. Caillau clamp [2x]
- 2** Fuel line



Connecting fuel line

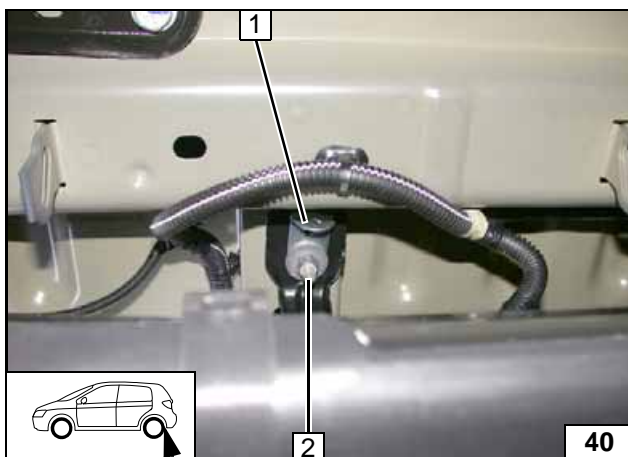

- 1** Angle bracket
- 2** Original vehicle stud bolt of fuel tank mount, large diameter washer, original vehicle nut

Installing metering pump

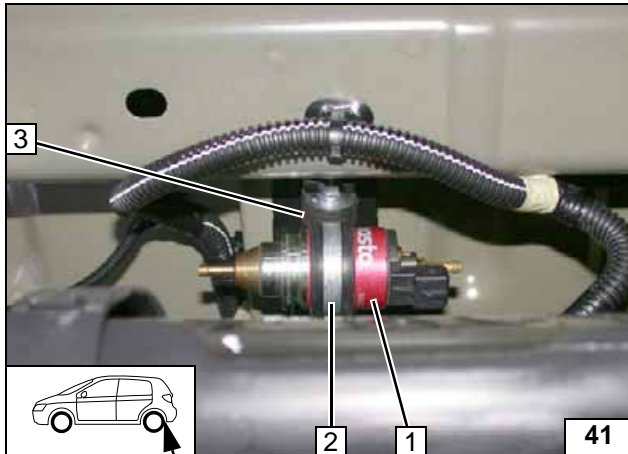

- 1 Metering pump
- 2 Rubber-coated pipe clamp
- 3 Silent block, flanged nut [2x]



Installing metering pump

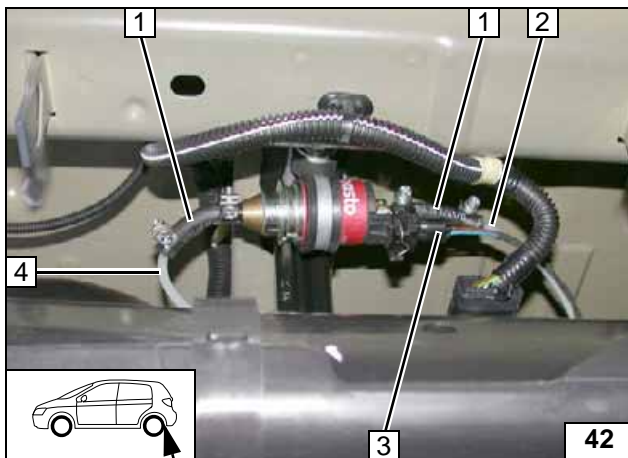

- 1 Hose section [2x], 10mm dia. clamp [4x]
- 2 Fuel line of Heater
- 3 Wiring harness of metering pump, connector mounted
- 4 Fuel line of fuel standpipe



Installing metering pump

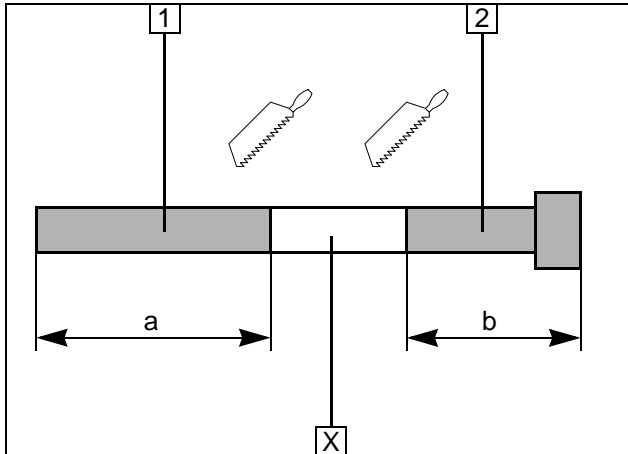
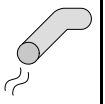

Exhaust gas

- 1 Exhaust pipe
a = 330
- 2 Exhaust end section
b = 260

Discard section X

Preparing exhaust pipe

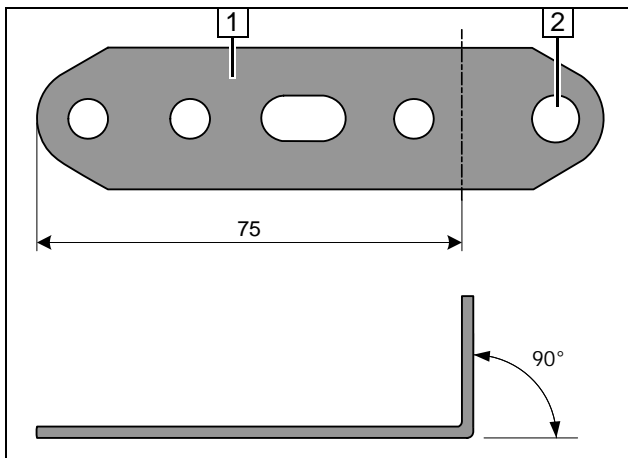

- 1 Perforated bracket
- 2 8.5mm dia. hole

Preparing perforated bracket

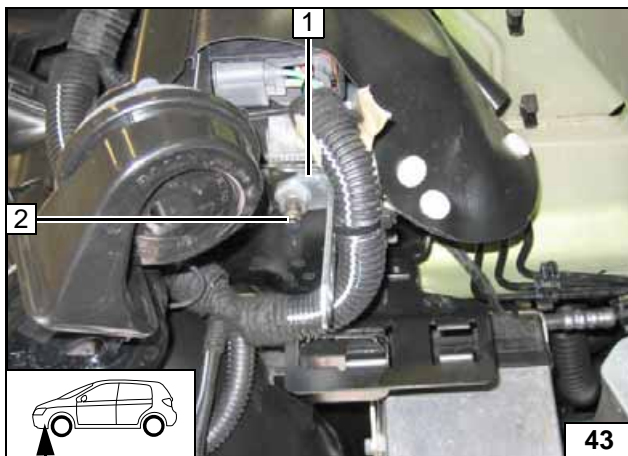

- 1 Perforated bracket
- 2 Original vehicle bolt

Installing perforated bracket

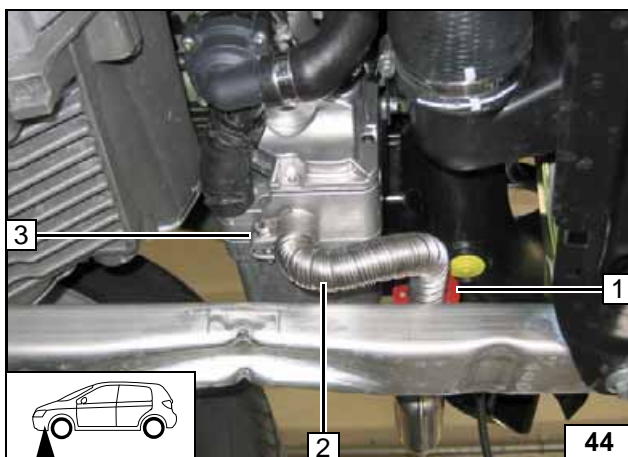

- 1 Red (rt) rubber isolator
- 2 Exhaust pipe
- 3 Hose clamp

Installing exhaust pipe

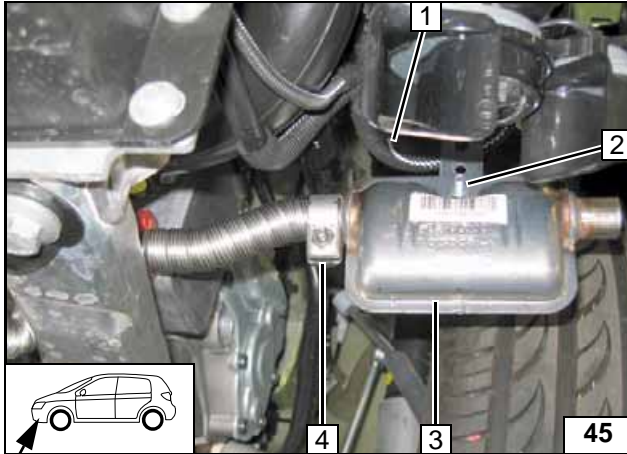
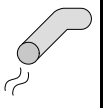

Secure original vehicle wiring harness **1** with cable tie.

- 2** M6x20 bolt, flanged nut
- 3** Silencer
- 4** Hose clamp



Installing silencer

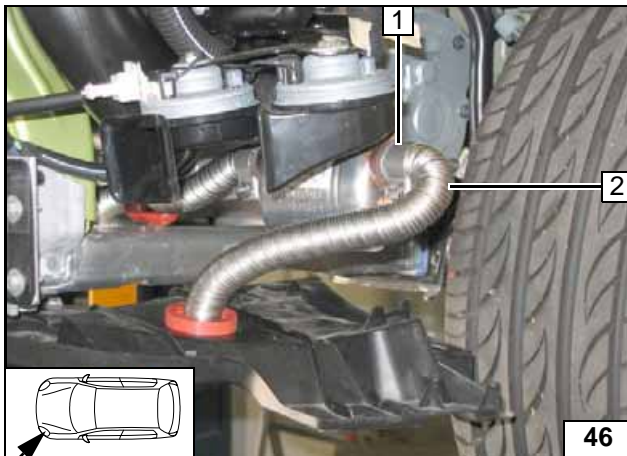

Ensure sufficient distance to neighbouring components.

- 1** Hose clamp
- 2** Exhaust end section



Installing exhaust end section

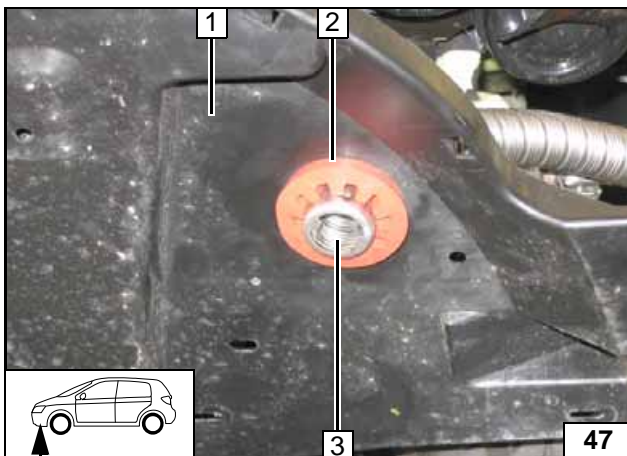

Drill 42mm dia. hole at position **3** in underbody protection **1** and insert red (rt) rubber isolator with groove **2**. Align exhaust end section **3** flush on rubber isolator **2**.



Positioning rubber isolator

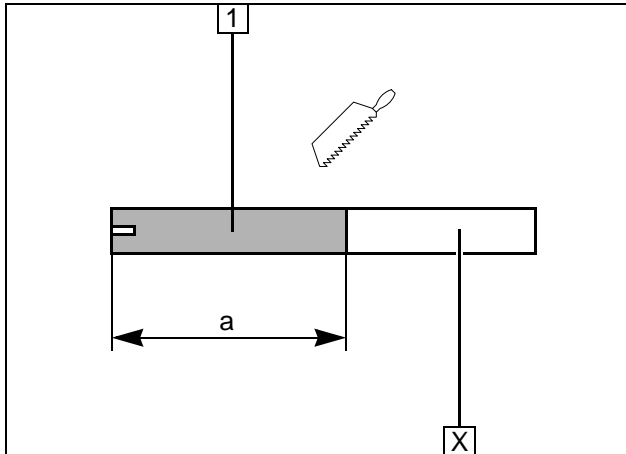
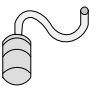

Combustion air

- 1 Combustion air pipe
a = 300

Discard section X

Cutting combustion air pipe to length

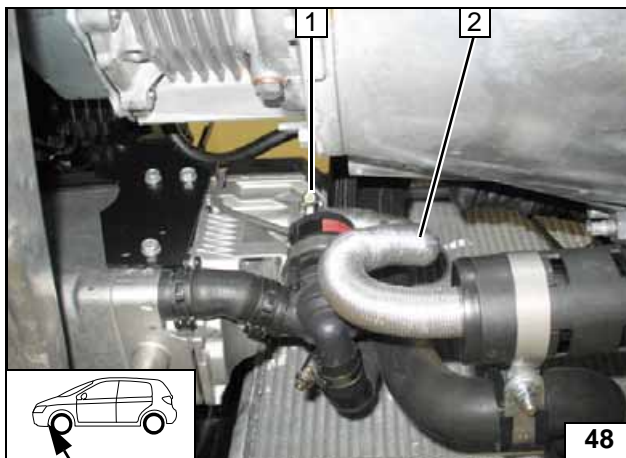

- 1 27 mm dia. clamp
- 2 Combustion air pipe

Installing combustion air pipe

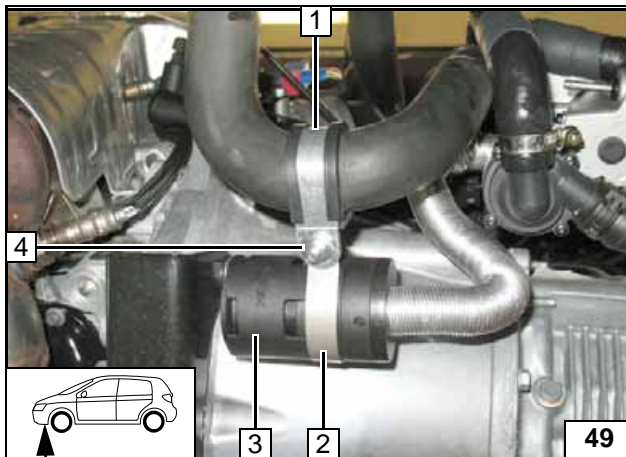

- 1 35mm dia. rubber-coated p-clamp
- 2 52mm dia. clamp
- 3 Silencer
- 4 M6x25 bolt, 10mm shim, flanged nut

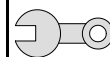

Installing silencer

**Final Work****WARNING!**

Mount removed parts in reverse order. Check all hoses, clamps and all electrical connections for firm seating. Insulate all loose wires and tie back.

Only use manufacturer-approved coolant. Spray heater components with anti-corrosion wax (Tectyl 100K, Order No. 111329).

- **Connect the battery.**
- **Fill and bleed the coolant circuit according to the vehicle manufacturer's specifications.**
- **Adjust digital timer, teach telestart transmitter**
- **Make settings on A/C control panel according to the "Operating Instructions for End Customer".**
- **Place signboard "Switch off parking heater before refuelling" in the area of the filler neck**
- **See installation instructions for initial start-up and function test**



Webasto AG
Postfach 80
D-82132 Stockdorf / Germany
National Hotline: 01805 93 22 78
(14 Cent aus dem deutschen Festnetz)
Hotfax: 0395 5592 353
Hotmail: technikcenter@webasto.com
<http://www.webasto.com>

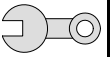

Template for Fuel Standpipe



100 mm



Scale 1:1

Compare the size of the printed version with dimension lines.
Permitted tolerance a maximum of 2%.

Set the printer settings to "no margin" or "minimise margins" and 100% of the normal size.

100 mm

0

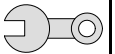

Operating Instructions for End Customer



Please remove page and add to the vehicle operating instructions.



Note:

We recommend matching the heating time to the driving time.

Heating time = driving time

Example:

For a driving time of approx. 20 min. (in one direction), we recommend not exceeding a switch-on time of 20 min.

If the summer/winter switch option has been installed, this must be switched in accordance with the time of year. The heater will then heat in the position Winter  and in the position Summer  it will only switch on the vehicle fan to ventilate the vehicle interior.



Before shutting off the engine, make the following settings:

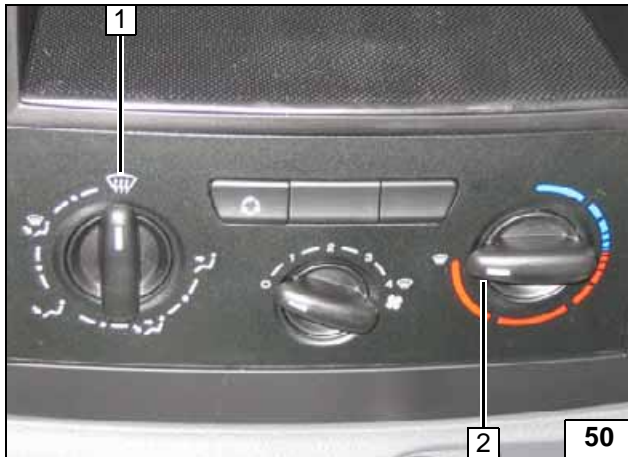

- 1 Air outlet to windscreen
- 2 Set temperature to "max"

Manual air conditioning



No specific settings necessary.



Automatic air-conditioning



Webasto AG
 Postfach 80
 D-82132 Stockdorf / Germany
 National Hotline: 01805 93 22 78
 (14 Cent aus dem deutschen Festnetz)
 Hotfax: 0395 5592 353
 Hotmail: technikcenter@webasto.com
 http://www.webasto.com