

# Water Heater

## Thermo Top Evo Parking Heater



## Installation Documentation Audi A6 / A6- Avant / Audi A7 Sportback

### Validity

Manufacturer	Model	Type	EG-BE No. / ABE
Audi	A6	4G	e1 * 2007 / 46 * 0436 * ...
Audi	A6 Avant	4G	e1 * 2007 / 46 * 0436 * ...
Audi	A7 Sportback	4G	e1 * 2007 / 46 * 0436 * ...

Motorisation	Fuel	Transmission type	Output in kW	Displacement in cm <sup>3</sup>	Engine code
2.0 TDI	Diesel	Multitronic	130	1968	CGLC
3.0 TDI quattro	Diesel	Multitronic	180	2967	CDUC
3.0 TDI quattro	Diesel	AG	235	2967	CVUA

AG = Automatic transmission

from model year 2011

Left-hand drive vehicle

**Verified equipment variants:** Comfort automatic air-conditioning / 4-zone comfort automatic air-conditioning  
 Passenger compartment monitoring  
 NebelscheinwerferXenon with headlight washer system  
 Front fog lights  
 NebelscheinwerferStart / Stop  
 LED headlight

**Total installation time:** about 10 hours

### Note:

Verify part number index of the A/C control panel at the connector end.  
 For A/C control panels that end with a double index (two letters, see section "Preliminary Work"), the installation should be carried out WITHOUT the time-delay relay.

# Audi A6 / A6- Avant / Audi A7 Sportback

## Table of Contents

Validity	1	Preparing Installation Location	14
Necessary Components	2	Preparing Heater	14
Installation Overview	2	Installing Heater	18
Information on Total Installation Time	2	Coolant Circuit 2.0 TDI	19
Information on Operating and Installation Instructions	3	Coolant Circuit 3.0 TDI	23
Information on Validity	4	Fuel	27
Technical Instructions	4	Exhaust Gas	31
Explanatory Notes on Document	4	Final Work	32
Preliminary Work	5	Adaptation of Climatronic J255 Control Unit	32
Heater Installation Location	5	Operating Instructions for End Customer	33
Preparing Electrical System	6		
Electrical System	8		
Fan Controller Without Time-Delay Relay	9		
Fan Controller With Time-Delay Relay	10		
MultiControl CAR Option	13		
Remote Option (Telestart)	13		

## Necessary Components

- Installation kit for Audi A6 / A6- Avant / Audi A7 Sportback 2011 Diesel: **1317499A**
- 2.0 TDI additionally requires:  
Additional kit for Audi A6 / A6- Avant / A7 2011 2.0 TDI: **1318098A**
- Heater control in accordance with price list and upon consultation with end customer
- In case of Telestart, Indicator lamp in accordance with price list and upon consultation with final customer

## Installation instructions:

- Arrange for the vehicle to be delivered with the tank only about ¼ full!
- The installation location of the push button in the case of Telestart or Thermo Call should be confirmed with the end customer.
- Depending on the available space and manufacturer's instructions, we recommend the use of a vehicle battery with more electrical capacity.

## Installation Overview

### Legend:

1. Heater
2. Fuse holder engine compartment
3. Circulating pump
4. MultiControl CAR
5. Metering pump

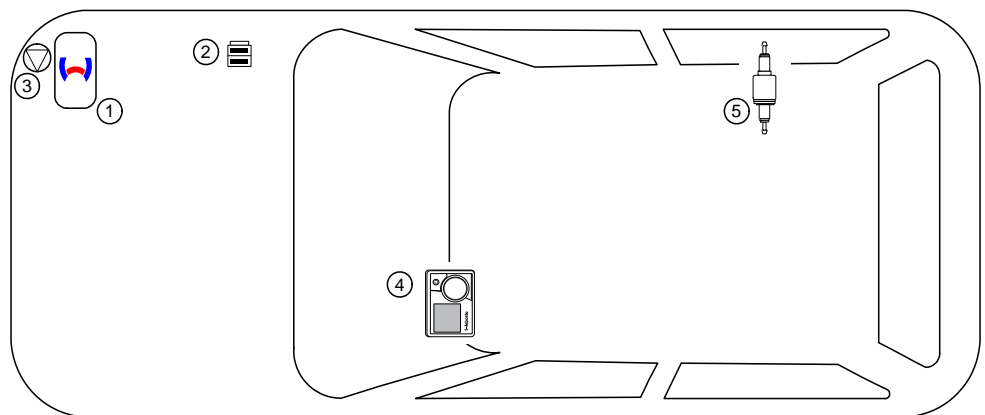

## Information on Total Installation Time

The total installation time includes the time needed for mounting and demounting of the vehicle-specific components, the heater specific installation time and all other times required for the system integration and initial start-up of the heater.

The total installation time may vary for vehicle equipment other than provided.

## Information on Operating and Installation Instructions

### 1 Important information (not complete)

#### 1.1 Installation and repair



The improper installation or repair of Webasto heating and cooling systems can cause fire or the leakage of deadly carbon monoxide, leading to serious injury or death.



To install and repair Webasto heating and cooling systems you need to have completed a special company training course and have the appropriate technical documentation, special tools and special equipment.



Installation and repair may ONLY be carried out by persons trained and certified in a Webasto training course. NEVER try to install or repair Webasto heating or cooling systems if you have not completed a Webasto training course, you do not have the necessary technical skills and you do not have the technical documentation, tools and equipment available to ensure that you can complete the installation and repair work properly.

Only use genuine Webasto parts. See the Webasto air and water heaters accessories catalogue for this purpose.

#### 1.2 Operation

To ensure safe operation, we recommend having the heater checked every two years by an authorised Webasto dealer, especially when used over a long period and/or under extreme environmental conditions.

Do not operate the heater in closed rooms due to the danger of poisoning and suffocation.

Always switch off the heater before refuelling.

The heater may only be used with the prescribed fuel Diesel (DIN EN 590) or petrol (DIN EN 228).

The heater may not be cleaned with a high-pressure cleaner.

#### 1.3 Please note

ALWAYS follow all Webasto installation and operating instructions and observe all warnings.

To become familiar with and understand all functions and properties of the heater, the operating instructions must be read carefully and observed at all times.

For proper, safe installation and repair work, the installation instructions with all warnings and safety information must be carefully read and observed at all times. Please always contact a workshop authorised by Webasto for all installation and repair work.

#### Important

**Webasto shall assume no liability for defects, damage and injuries resulting from a failure to observe the installation, repair and operating instructions of the information contained in them.**

**This liability exclusion particularly applies to improper installations and repairs, installations and repairs by untrained persons or in the case of a failure to use genuine spare parts.**

**The liability due to culpable disregard to life, limb or health and due to damage or injuries caused by a wilful or reckless breach of duty remain unaffected, as does the obligatory product liability.**

Installation should be carried out according to the general, standard rules of technology. Unless specified otherwise, fasten hoses, lines and wiring harnesses to original vehicle lines and wiring harnesses using cable ties. Insulate loose wire ends and tie back. Connectors on electronic components must audibly click into place during installation.

Sharp edges should be fitted with rub protection. Spray unfinished body areas, e.g. drilled holes, with anti-corrosion wax (Tectyl 100K, Order No. 111329).

Observe the instructions and guidelines of the respective vehicle manufacturer for demounting and mounting vehicle specific components!

The initial start-up is to be executed with the Webasto Thermo Test Diagnosis.

When installing a programmable control module (e.g. a PWM Gateway), the corresponding settings must be checked or adjusted.

### 2 Statutory regulations governing installation

Guidelines	TT-Evo
Heating Directive ECE R122	E1 00 0258
EMC Directive ECE R10	E1 04 5627

#### Note

The regulations of these guidelines are binding in the scope of the Directive 70/156/EEC and/or 2007/46/EC (for new vehicle models from 29/04/2009) and should also be observed in countries in which there are no special regulations.

#### Important

Failure to follow the installation instructions will result in the invalidation of the type approval for the heater and therefore invalidation of the general **homologation of the vehicle**.

#### Note

The heater is licensed in accordance with paragraph 19, section 3, No. 2b of the StVZO (German Road Traffic Licensing Authority).

### 2.1 Excerpt from the directive 122 (heater) section 5 for the installation of the heater.

Beginning of excerpt.

#### ANNEX VII

#### REQUIREMENTS FOR COMBUSTION HEATERS AND THEIR INSTALLATION

##### 1. GENERAL REQUIREMENTS

1.7.1. A clearly visible tell-tale in the operator's field of view shall inform when the combustion heater is switched on or off.

##### 2. VEHICLE INSTALLATION REQUIREMENTS

###### 2.1. Scope

2.1.1. Subject to paragraph 2.1.2. combustion heaters shall be installed according to the requirements of this Annex.

2.1.2. Vehicles of category O having liquid fuel heaters are deemed to comply with the requirements of this Annex.

###### 2.2. Positioning of the heater

2.2.1. Body sections and any other components in the vicinity of the heater must be protected from excessive heat and the possibility of fuel or oil contamination.

2.2.2. The combustion heater shall not constitute a risk of fire, even in the case of overheating. This requirement shall be deemed to be fulfilled if the installation ensures an adequate distance to all parts and suitable ventilation, by the use of fire resistant materials or by the use of heat shields.

2.2.3. In the case of M2 and M3 vehicles, the heater must not be positioned in the passenger compartment. However, an installation in an effectively sealed envelope which also complies with the conditions in paragraph 2.2.2 may be used.

2.2.4. The label referred to in paragraph 1.4 or a duplicate, must be positioned so that it can be easily read when the heater is installed in the vehicle.

2.2.5. Every reasonable precaution should be taken in positioning the heater to minimise the risk of injury and damage to personal property.

###### 2.3. Fuel supply

2.3.1. The fuel filler must not be situated in the passenger compartment and must be provided with an effective cap to prevent fuel spillage

2.3.2. In the case of liquid fuel heaters, where a supply separate to that of the vehicle is provided, the type of fuel and its filler point must be clearly labelled

2.3.3. A notice, indicating that the heater must be shut down before refuelling, must be affixed to the filler neck. In addition a suitable instruction must be included in the manufacturer's operating manual.

###### 2.4. Exhaust system

2.4.1. The exhaust gas outlet must be located so as to prevent emissions from entering the vehicle through ventilators, heated air inlets or opening windows.

###### 2.5. Combustion air inlet

2.5.1. The air for the combustion chamber of the heater must not be drawn from the passenger compartment of the vehicle.

2.5.2. The air inlet must be so positioned or guarded that blocking by rubbish or luggage is unlikely.

###### 2.6. Heating air inlet

2.6.1. The heating air supply may be fresh or recirculated air and must be drawn from a clean area not likely to be contaminated by exhaust fumes emitted either by the propulsion engine, the combustion heater or any other vehicle source.

2.6.2. The inlet duct must be protected by mesh or other suitable means.

###### 2.7. Heating air outlet

2.7.1. Any ducting used to route the hot air through the vehicle must be so positioned or protected that no injury or damage could be caused if it were to be touched.

2.7.2. The air outlet must be so positioned or guarded that blocking by rubbish or luggage is unlikely.

End of excerpt.

In multilingual versions the German language is binding.

# Audi A6 / A6- Avant / Audi A7 Sportback

## Information on Validity

This installation documentation applies to Audi A6 / A6- Avant / Audi A7 Sportback Diesel vehicles - for validity, see page 1 - from model year 2011 and later, assuming technical modifications to the vehicle do not affect installation, any liability claims excluded. Depending on the vehicle version and equipment, modifications may be necessary during installation with respect to this installation documentation.

Vehicle and engine types, equipment variants and other specifications not listed in this installation documentation have not been tested. However, installation according to this installation documentation may be possible.

## Technical Instructions

### Special Tools

- Hose clamp pliers for self-clamping hose clamps
- Hose clamp pliers for Clic hose clamps of type W
- Automatic wire stripper 0.2 - 6mm<sup>2</sup>
- Crimping pliers for cable lug / tab connector 0.5 - 6mm<sup>2</sup>
- Torque wrench for 2.0 - 10 Nm
- Hose clamping pliers
- Metric thread-setter kit
- 25mm dia. punching tool
- Webasto Thermo Test diagnosis with current software

### Measurements

- All measurements are in mm!















### Tightening torque values

- Tightening torque values of 5x13 heater bolts and 5x11 heater stud bolts = 8Nm.
- Tightening torque value of 5x15 water connection piece retaining plate bolt = 7Nm.
- Tighten other screw connections in accordance with manufacturer's instructions or in accordance with state-of-the-art-technology.

## Explanatory Notes on Document

You will find an identification mark on the outside top right corner of the page in question to provide you with a quick overview of the individual working steps.

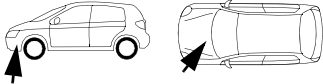
Special features are highlighted using the following symbols:

<b>Mechanical System</b>		<b>Specific risk of injury or fatal accidents.</b>	
<b>Electrical System</b>		<b>Specific risk due to electrical voltage.</b>	
<b>Coolant Circuit</b>		<b>Specific risk of damage to components.</b>	
<b>Combustion Air</b>		<b>Specific risk of fire or explosion.</b>	
<b>Fuel</b>		<b>Reference to general installation instructions of Webasto components or to the manufacturer's vehicle-specific documents.</b>	
<b>Exhaust Gas</b>		<b>Reference to a special technical feature.</b>	
<b>Software</b>		<b>The arrow in the vehicle icon indicates the position on the vehicle and the viewing angle.</b>	
		<b>Tightening torque according to the vehicle-specific documents.</b>	

# Audi A6 / A6- Avant / Audi A7 Sportback

## Preliminary Work

### Vehicle

- Open the fuel tank cap.
- Ventilate the fuel tank.
- Close the fuel tank cap again.
- Depressurise the cooling system.
- Disconnect the battery (car boot).
- Remove the cover and gasket of the coolant reservoir.
- Remove the engine design cover.
- Remove the air filter together with the intake hose.
- Remove the right-hand front wheel.
- Remove the right-hand front wheel well trim.
- Remove the engine trim, the underride protection.
- Remove the underbody trim on the right.
- Remove the seats.
- Remove the fuel-tank sending unit in accordance with the manufacturer's instructions.
- Remove the lower instrument panel trim on the front passenger's side.
- Remove the glove compartment.
- Remove the A-pillar trim on the front passenger's side.
- Remove the A/C control panel in accordance with the manufacturer's instructions.



In case of an A/C control panel part number that ends with a double index: Installation **without** a time-delay relay!

- 1 A/C control panel
- 2 Part number with a double index



**Checking  
A/C control  
panel part  
number**

### Heater

- Remove years that do not apply from the type and duplicate label.
- Attach the duplicate label (type label) visibly in the appropriate place in the engine compartment.

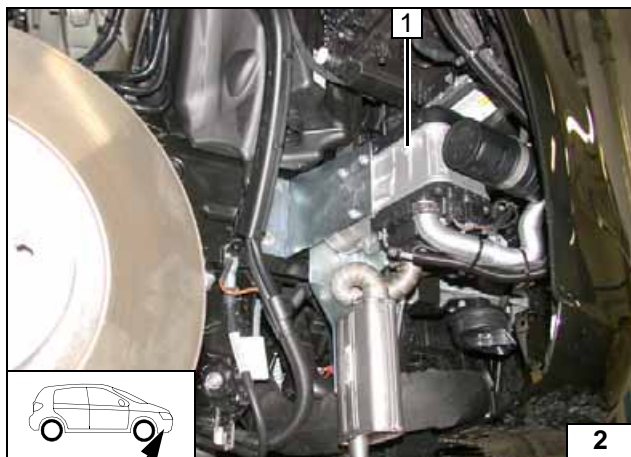

### Heater Installation Location

- 1 Heater

**Installation  
Location**

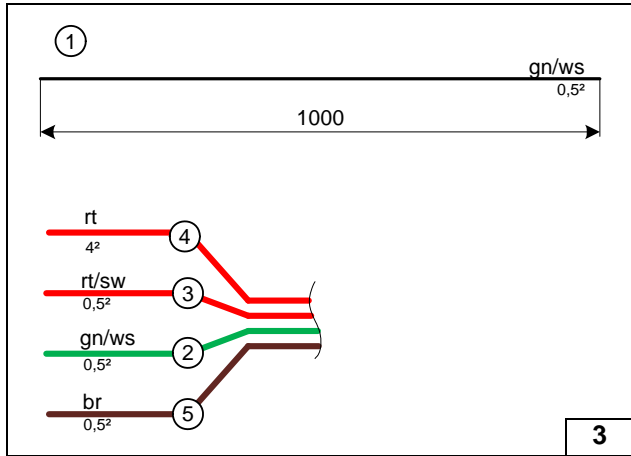
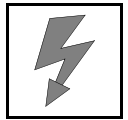

**Preparing Electrical System**

Wire sections retain their numbering throughout the whole document.

Produce all following electrical connections as shown in wiring diagram.

- ① Green/white (gn/ws) wire
- ② Green/white (gn/ws) wire from X1/5 of heater wiring harness
- ③ Red/black (rt/sw) wire from X10 of heater wiring harness
- ④ Red (rt) wire from F2 of heater wiring harness
- ⑤ Brown (br) wire from X2/2 of heater wiring harness



**Assigning wires**

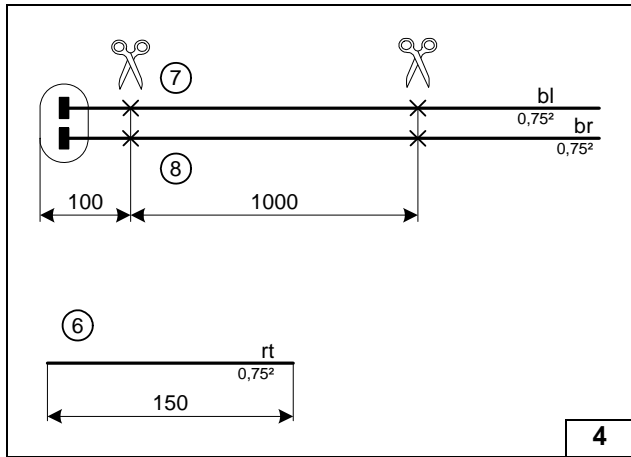

**Only if installing time-delay relay**

Cut off connectors of metering pump and 100mm of brown (br) wire ⑧ and blue (bl) wire ⑦ (the connector will be reinstalled later with the butt connector). 1000mm of the brown (br) wire and the blue (bl) wire will be needed for the connection of the time-delay relay.



**Cutting metering pump wiring harness to length, assigning wires**

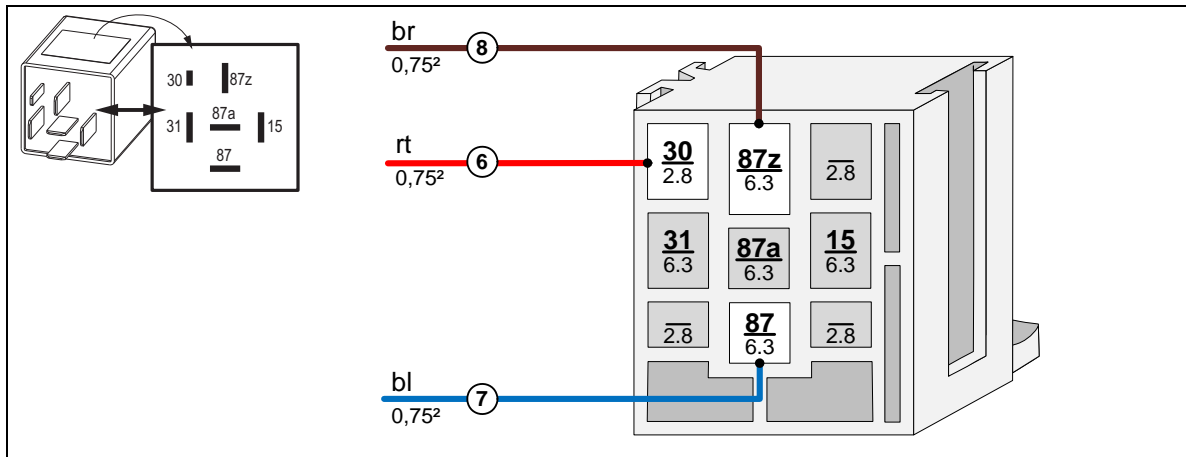

**Connecting wires to time-delay relay socket**

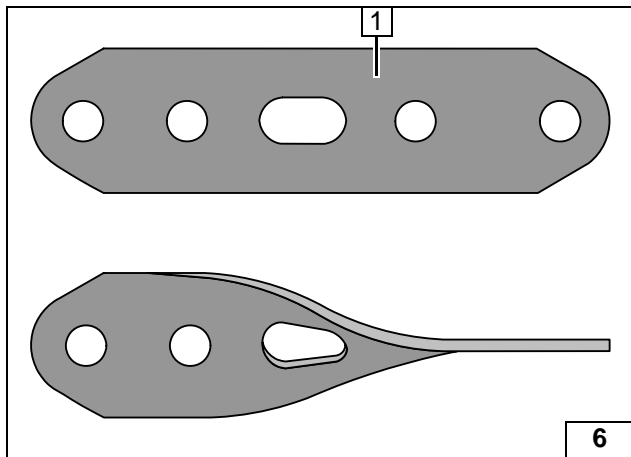

**All vehicles**

- 1 Turn perforated bracket about 90° in its longitudinal axis

**Preparing perforated bracket**

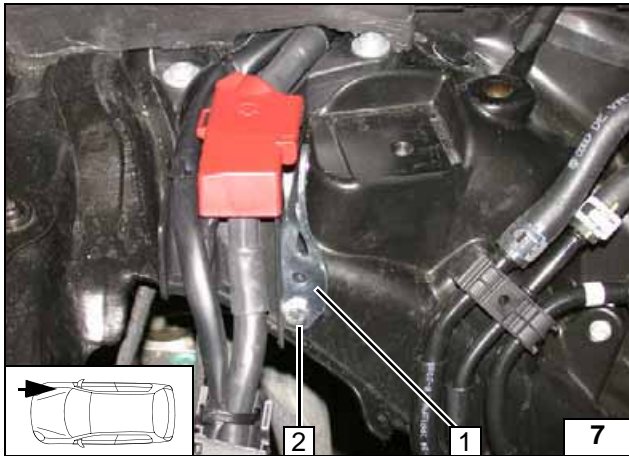

- 1 Perforated bracket
- 2 M6x20 bolt, flanged nut, existing hole

Installing perforated bracket

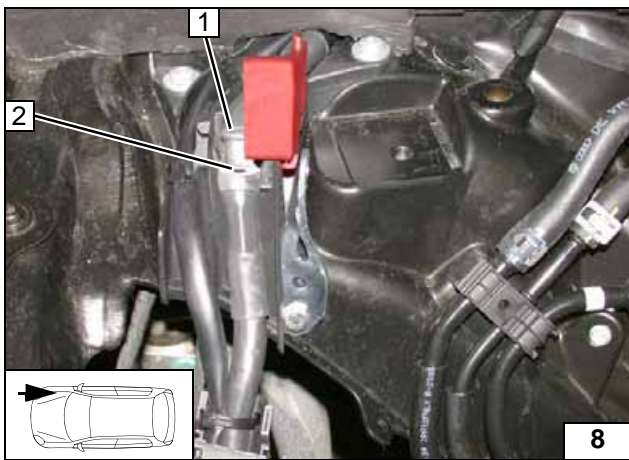

Cut thread of M6 in existing hole 2 of positive support point 1 (check depth, about 8mm)!



Preparing positive support point

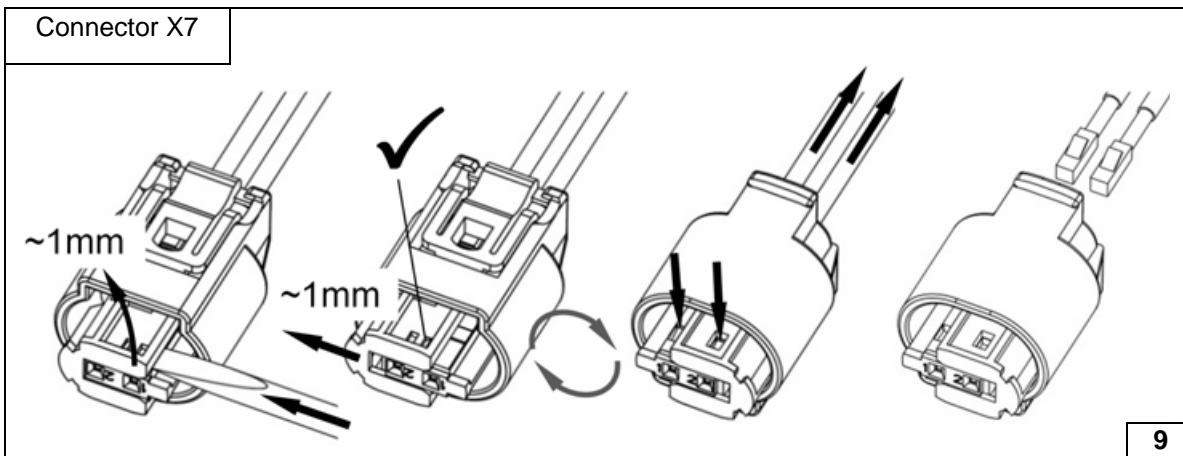

Dismantling connector of metering pump



## Electrical System

### Positive and earth wire

Shorten M6x20 bolt to 10mm!

- 1 M6x10 bolt, toothed washer, cable lug, positive wire on positive support point
- 2 Earth wire on original vehicle earth support point

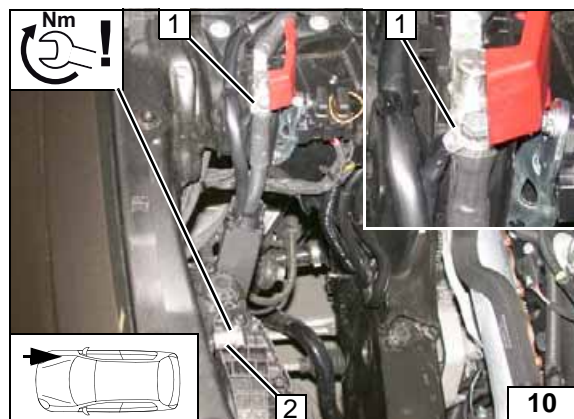

### Wiring harness pass through

- 1 Wiring harnesses of heater, heater control
- 2 Protective rubber plug (hidden)

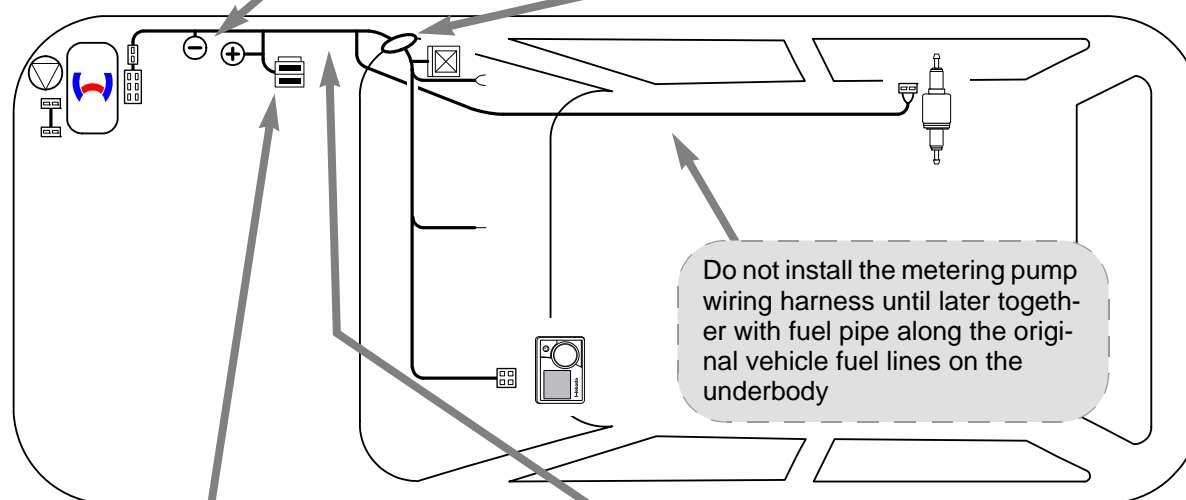
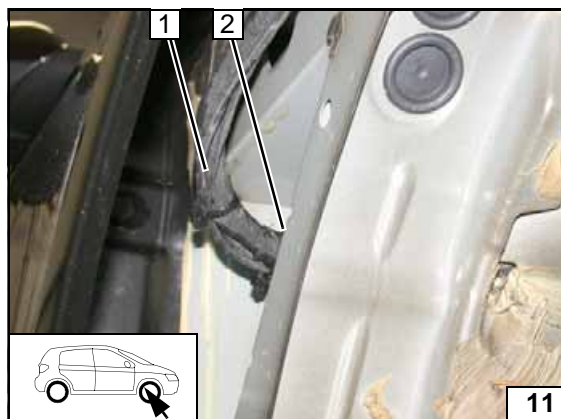

Wiring harness routing diagram

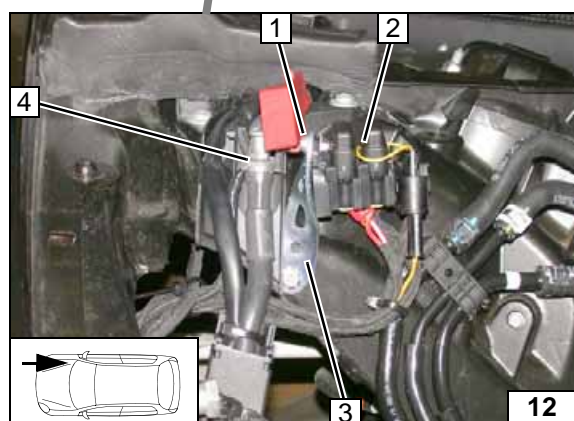

### Fuse holder engine compartment

Observe sufficient distance to positive support point  
4. If necessary, bend perforated bracket 3 again!

- 1 M5x16 bolt, washer [2x], nut
- 2 F1-2 fuses (replace F2 with 1A)

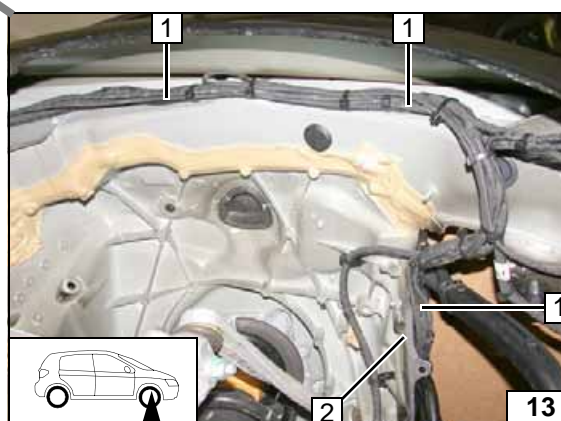

### Wiring Harness Routing

Cut edge protection in middle!

- 1 Wiring harnesses of heater, heater control
- 2 50 mm edge protection



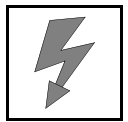

Fan Controller Without Time-Delay Relay

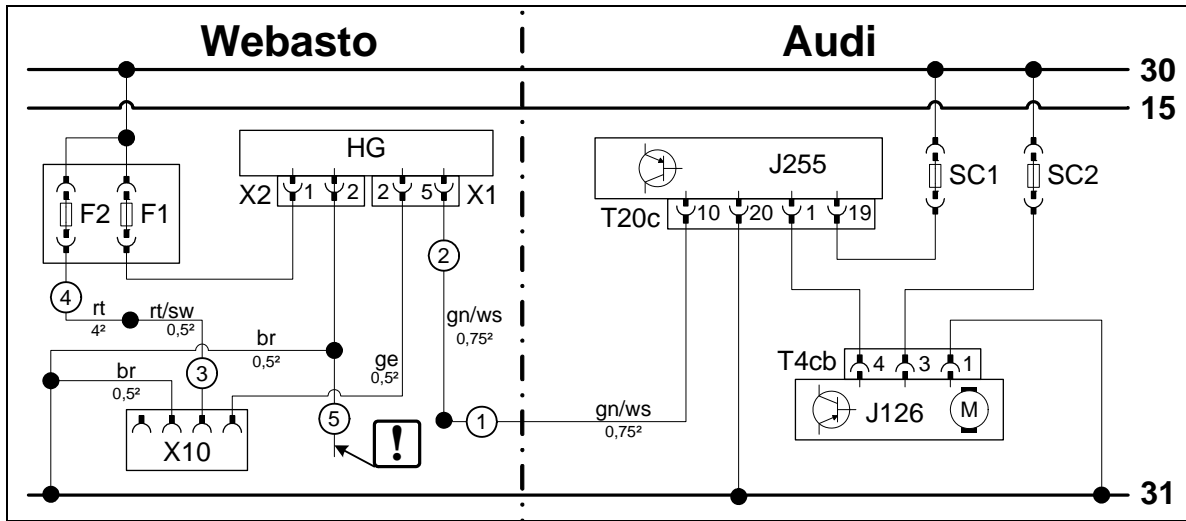

Wiring diagram

Webasto components		Vehicle components		Colours and symbols	
HG	TT-Evo heater	J255	A/C control unit	rt	red
X1	6-pin heater connector	T20c	20-pin connector J255	sw	black
X2	2-pin heater connector	SC1	Fuse	ge	yellow
F1	Fuse 20A	SC2	Fuse	gn	green
F2	Replace 30A with 1 A fuse.	J126	Fan unit	ws	white
X10	4-pin connector of heater control	T4cb	4-pin J126 connector	br	brown
					Insulate wire ends and tie back
Wiring colours may vary.					

Legend

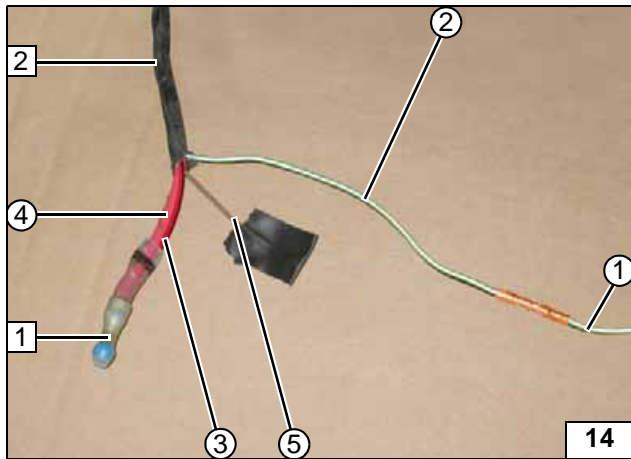

Route green/white (gn/ws) wire of J255 T20c/10 ① to the A/C control unit.



- 1 Solder wire terminator
- 2 Wiring harness of heater
- ① Green/white (gn/ws) wire of J255 T20c/10
- ② Green/white (gn/ws) wire from X1/5 of heater wiring harness
- ③ Red/black (rt/sw) wire from X10 of heater wiring harness
- ④ Red (rt) wire from F2 of heater wiring harness
- ⑤ Brown (br) wire from X2/2 of heater wiring harness (insulate and tie back)

Preparing wiring harness of passenger compartment

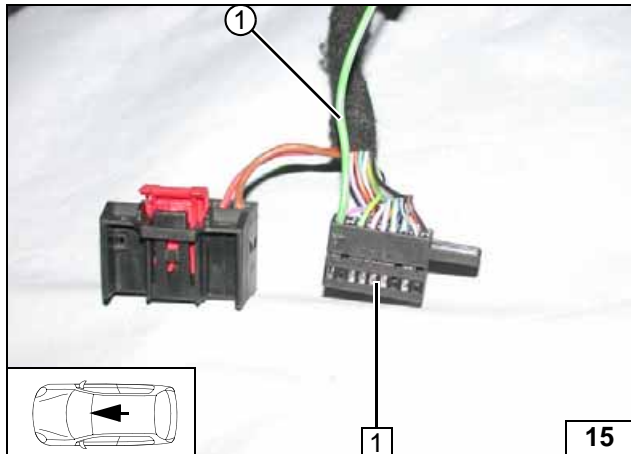

Connection to 20-pin T20c connector 1 of A/C control unit, pin 10. Crimp microtimer onto green/white (gn/ws) wire ① and insert into free pin 10 socket.



- 1 T20c connector dismantled

Connection of A/C control unit



Fan Controller With Time-Delay Relay

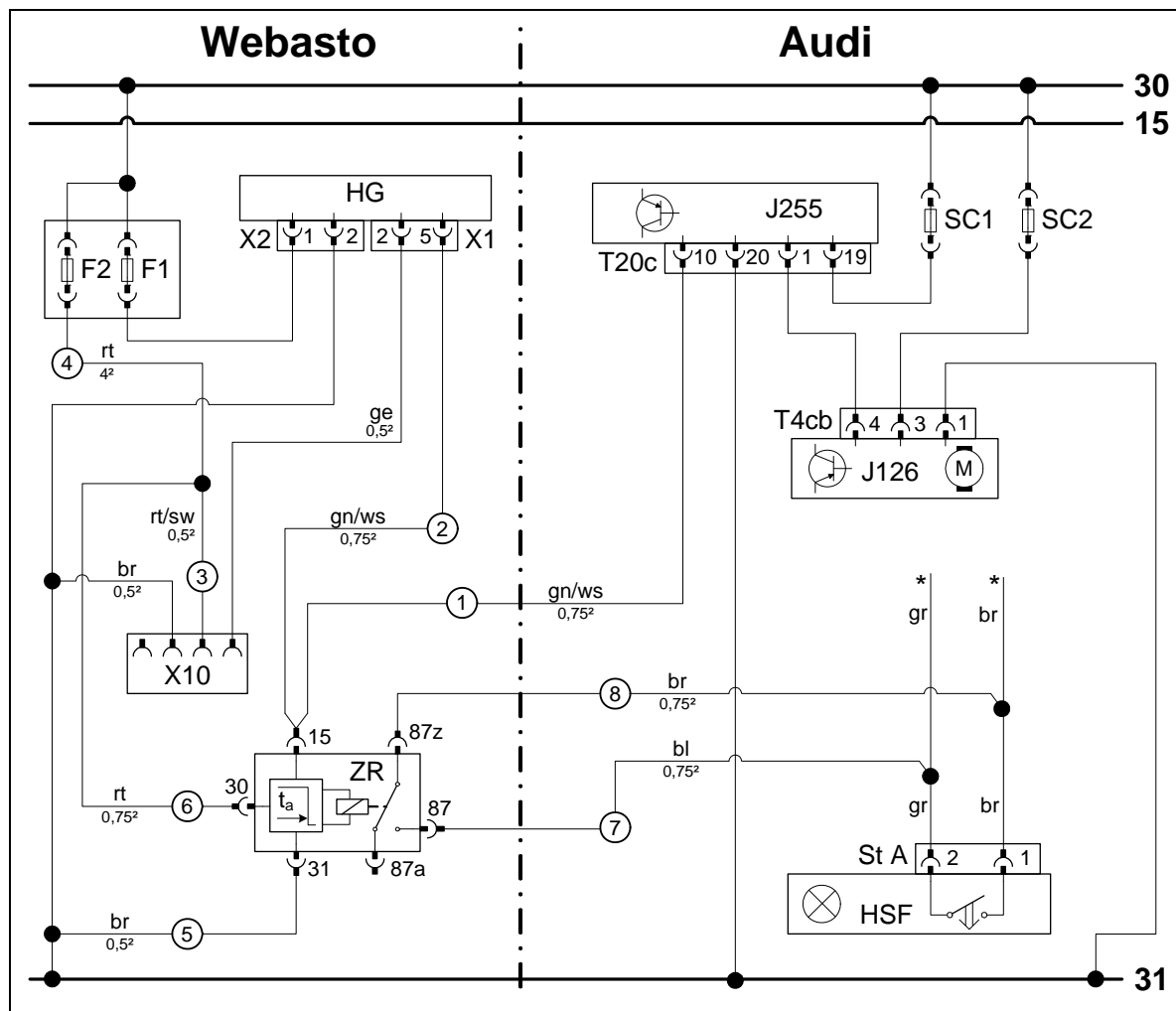

Wiring diagram

Webasto components		Vehicle components		Colours and symbols	
HG	TT-Evo heater	J255	A/C control unit	rt	red
X1	6-pin heater connector	T20c	20-pin connector J255	sw	black
X2	2-pin heater connector	SC1	Fuse	ge	yellow
F1	Fuse 20A	SC2	Fuse	gn	green
F2	Replace 30A with 1 A fuse.	J126	Fan unit	ws	white
X10	4-pin connector of heater control	T4cb	4-pin J126 connector	br	brown
ZR	Time-delay relay	HSF	Switch for glove compartment lighting	gr	grey
		ST A	2-pin connector HSF	bl	blue
				*	Wiring harness of glove compartment lighting
				X	Cutting point
					Wiring colours may vary.

Legend

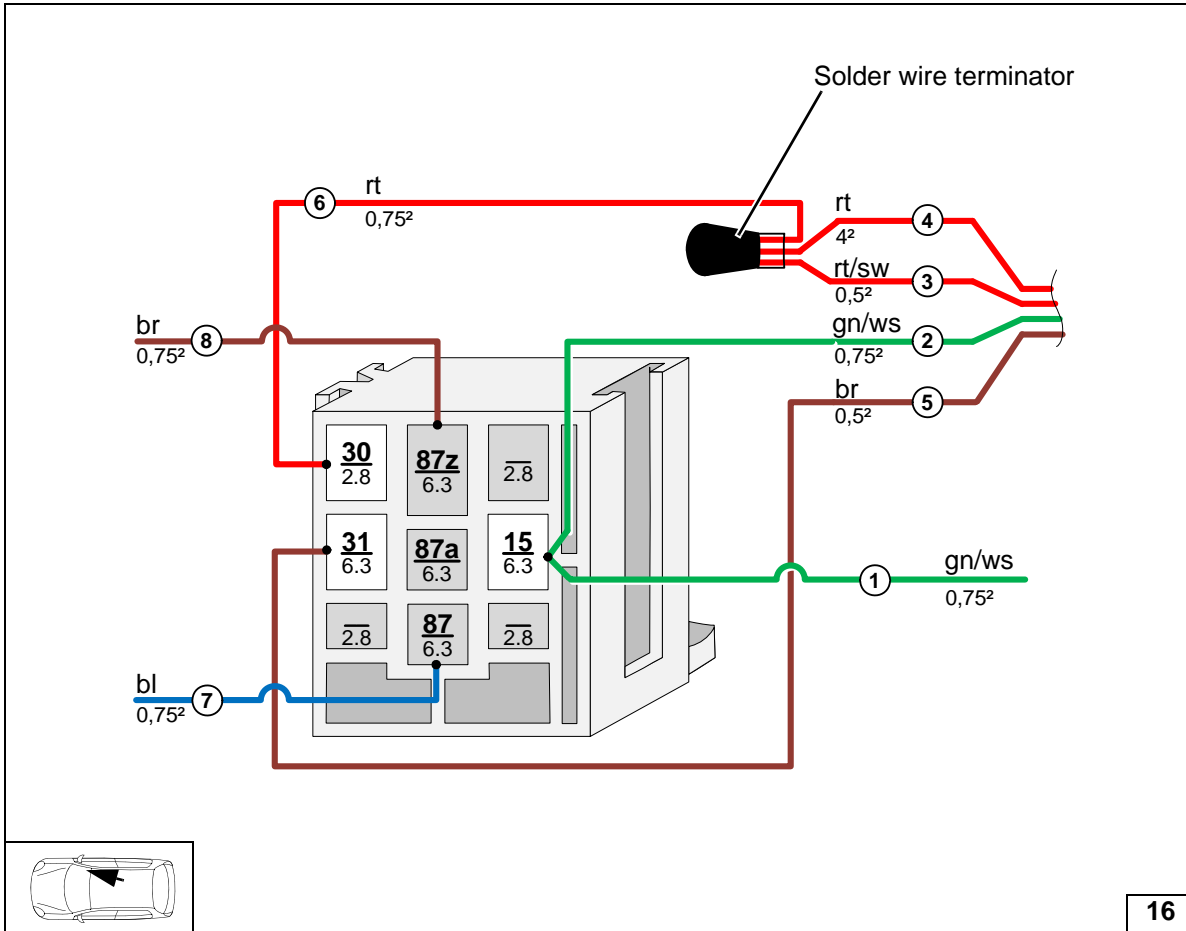
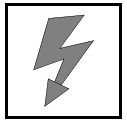

Connecting wires to socket of passenger compartment time-delay relay

16

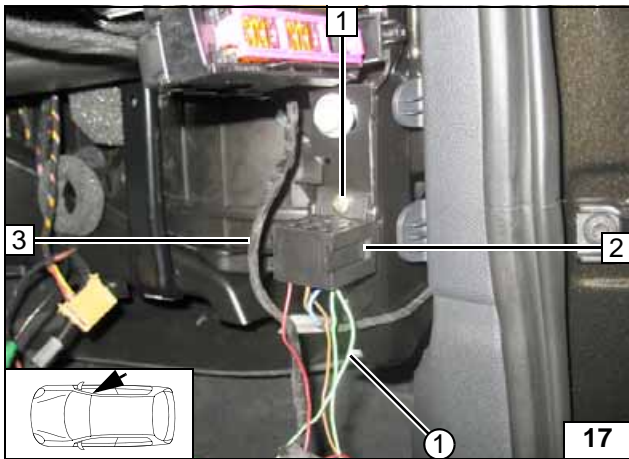

Route green/white (gn/ws) wire of J255 T20c/10 ① to the A/C control unit. 4.5 mm dia. hole at position 1. Route wiring harness ZR 3 to glove compartment lighting connector!

- 1 Self-tapping screw 5.5x13
- 2 Socket ZR

Mounting time-delay relay socket

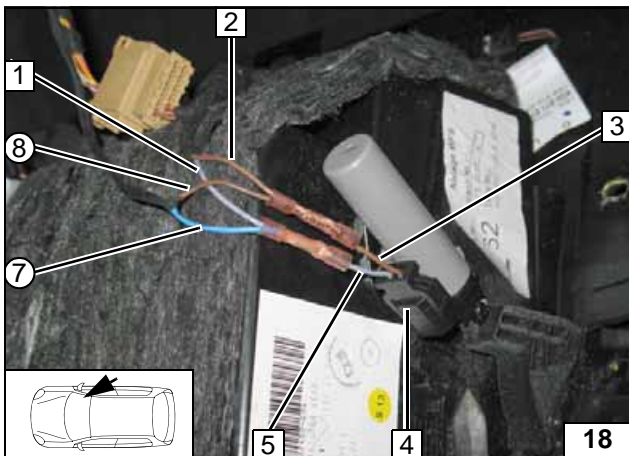

Connection to 2-pin connector 4 of glove compartment lighting.

- 1 Grey (gr) wire of glove compartment lighting wiring harness
- 2 Brown (br) wire of glove compartment lighting wiring harness
- 3 Brown (br) wire of 2-pin connector pin 1
- 5 Grey (gr) wire of 2-pin connector pin 2
- ⑦ Blue (bl) wire of ZR/87
- ⑧ Brown (br) wire of ZR/87z

Connecting glove compartment lighting

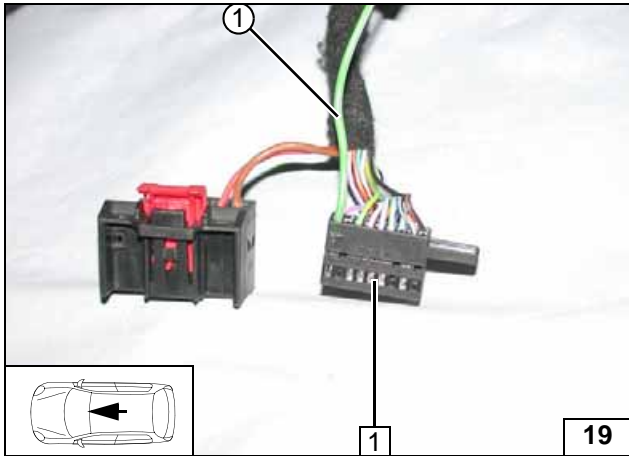
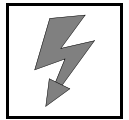

Connection to 20-pin T20c connector 1 of A/C control unit, pin 10. Crimp microtimer onto green/white (gn/ws) wire ① and insert into free pin 10 socket.

1 T20c connector dismantled

**Connec-  
tion of A/C  
control unit**

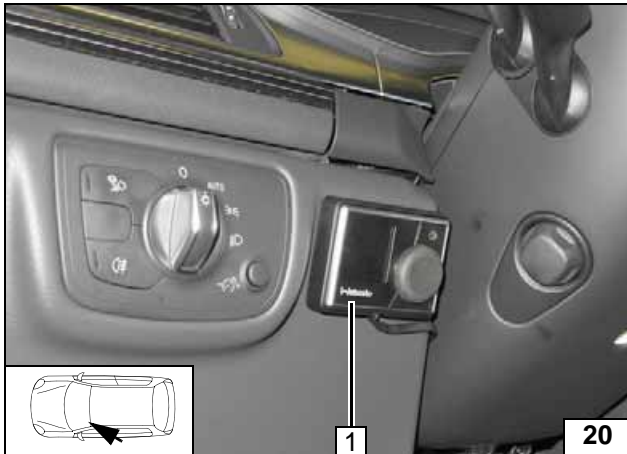

### MultiControl CAR Option

- 1 MultiControl CAR with installation frame



Installing  
MultiControl  
CAR

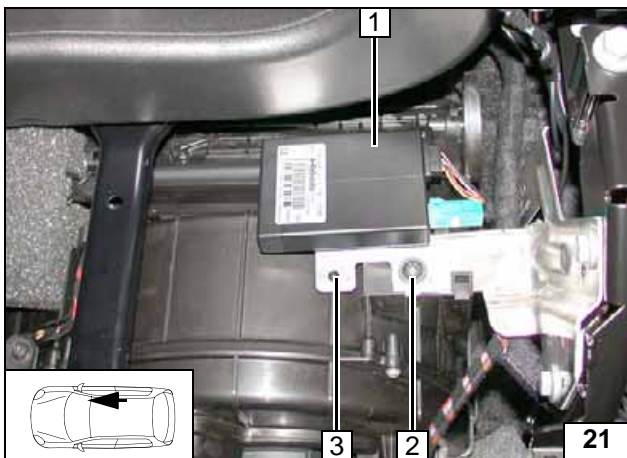

### Remote Option (Telestart)

- 1 Receiver
- 2 Original vehicle bolt
- 3 Bracket



Installing  
receiver

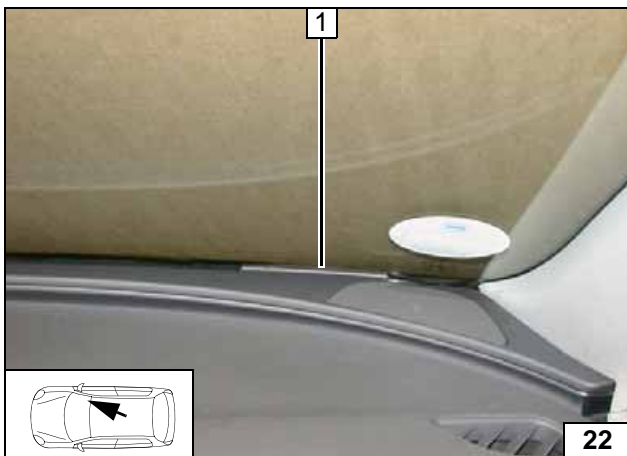

- 1 Antenna

Installing  
antenna

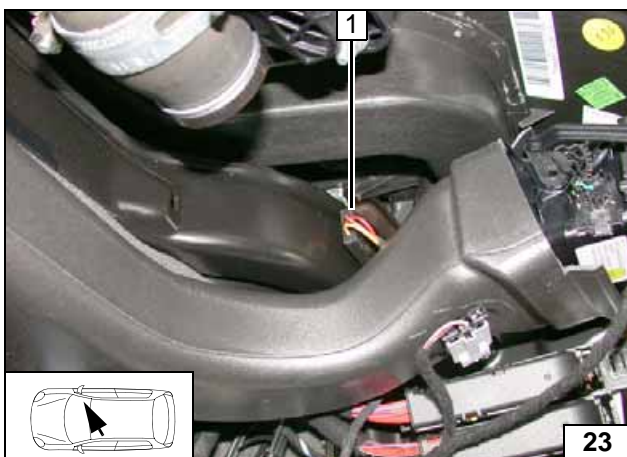

### Temperature sensor T100 HTM

Fasten temperature sensor 1 with adhesive tape.



Installing  
tempera-  
ture sensor

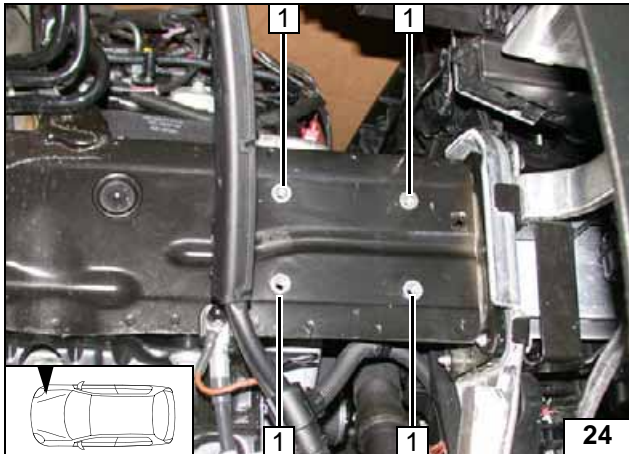
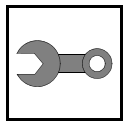

### Preparing Installation Location

- 1 Existing hole, install rivet nut [4x]

Installing rivet nut

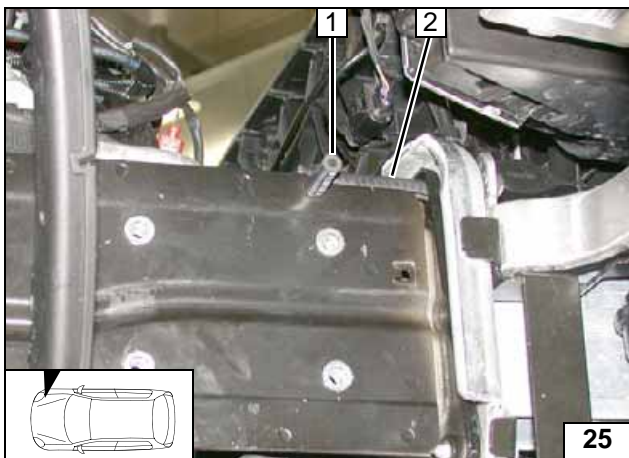

- 1 Fuel hose on original vehicle stud bolt
- 2 50 mm edge protection

Installing edge protection

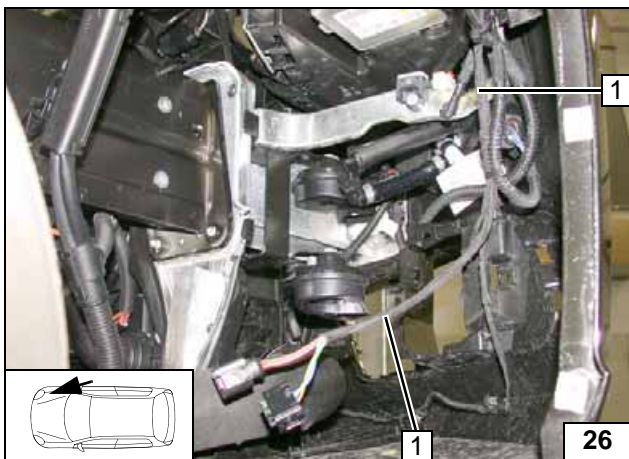

- 1 Wiring harness of heater

Routing wiring harness of heater

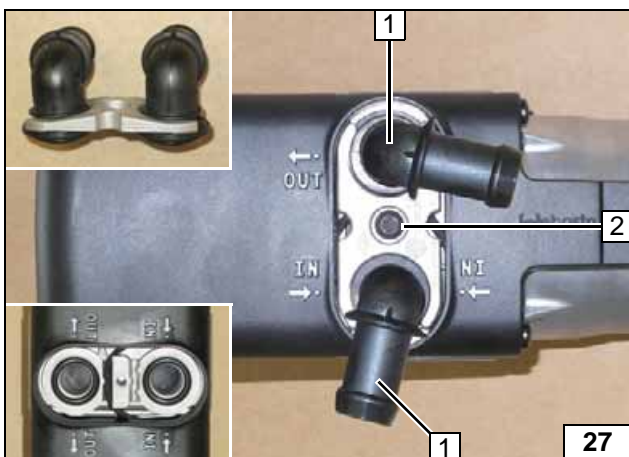

### Preparing Heater

- 1 Water connection piece, sealing ring [2x each]
- 2 Self-tapping bolt 5x15, retaining plate, water connection piece



Assembling water connection piece

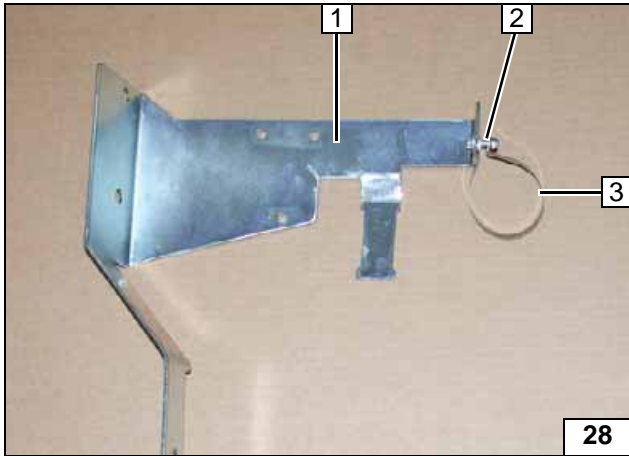

- 1 Bracket part A
- 2 Mount M5x16 bolt, self-locking nut, loosely
- 3 51mm dia. clamp

Premounting clamp

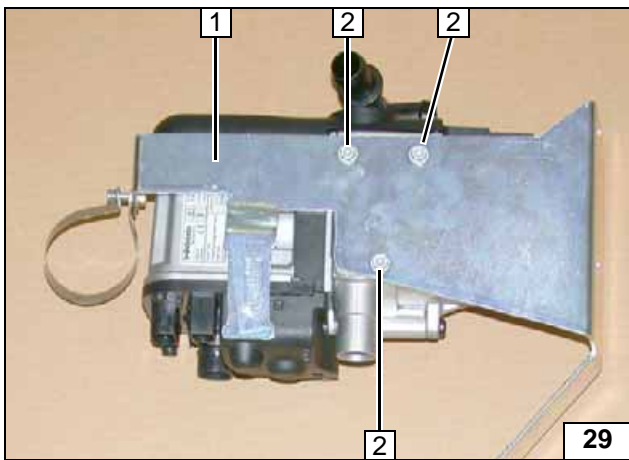

- 1 Bracket part A
- 2 Self-tapping bolt 5x13 [3x]

Installing bracket

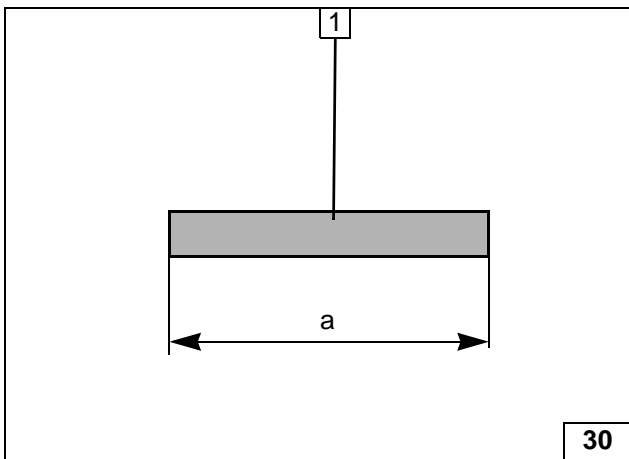

- 1 Exhaust pipe  
a = 230

View of exhaust pipe

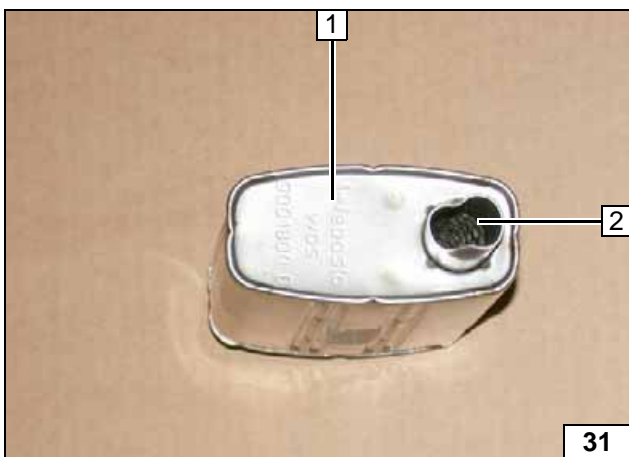

Lightly bend exhaust end section 2 at the end as shown (threaded insert points to the right).



- 1 Silencer

Preparing silencer

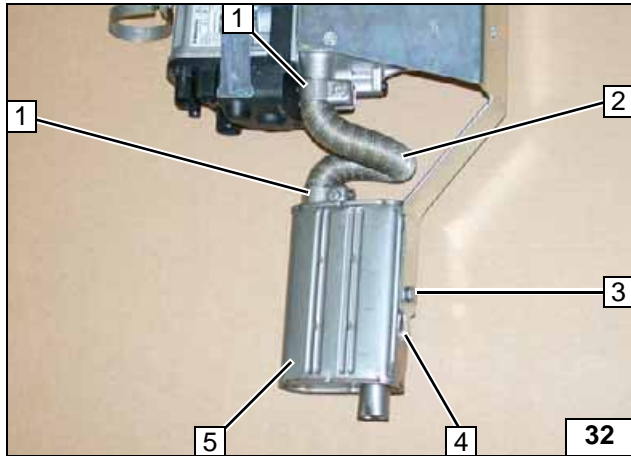

- 1 Hose clamp [2x]
- 2 Exhaust pipe
- 3 M6x16 bolt, spring lockwasher
- 4 Locking tab of bracket part A (twist protection)
- 5 Silencer

Premounting exhaust pipe and silencer

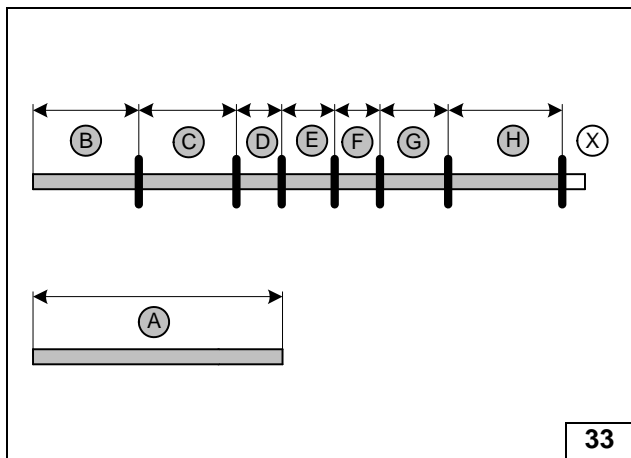

**2.0 TDI**

Discard section X.

- A = 800
- B = 100
- C = 150
- D = 80
- E = 90
- F = 60
- G = 230
- H = 700



Cutting hoses to length

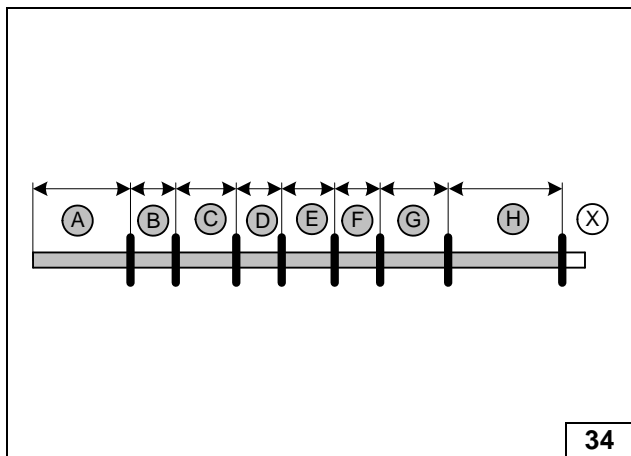

**3.0 TDI**

Discard section X.

- A = 590
- B = 80
- C = 150
- D = 80
- E = 90
- F = 60
- G = 210
- H = 740



Cutting hoses to length

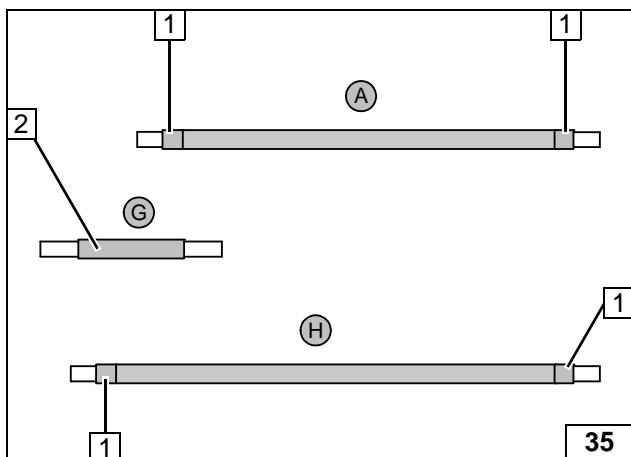

**All vehicles**

Slide braided protection hoses onto hoses A and H and cut to length (3.0 TDI only). Heat shrink plastic tubing on position 1, 3.0 TDI only.

- 1 50 mm long heat shrink plastic tubing [4x]
- 2 150 mm long heat shrink plastic tubing



Preparing hoses



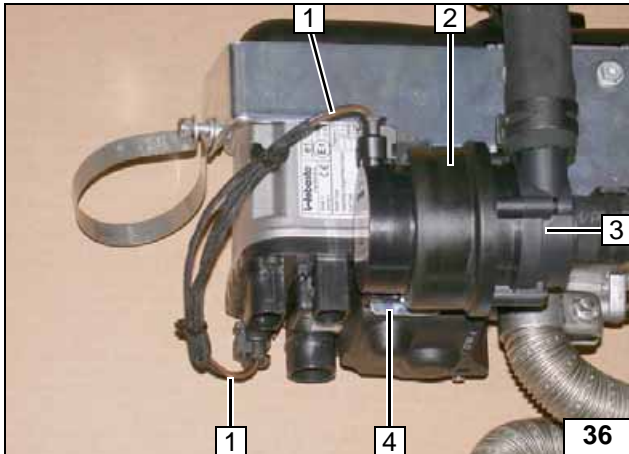

Install circulating pump mount **2** onto bracket part **A** at position **4**!

- 1** Install connector of circulating pump wiring harness [2x]
- 3** Circulating pump



**Mounting circulating pump**

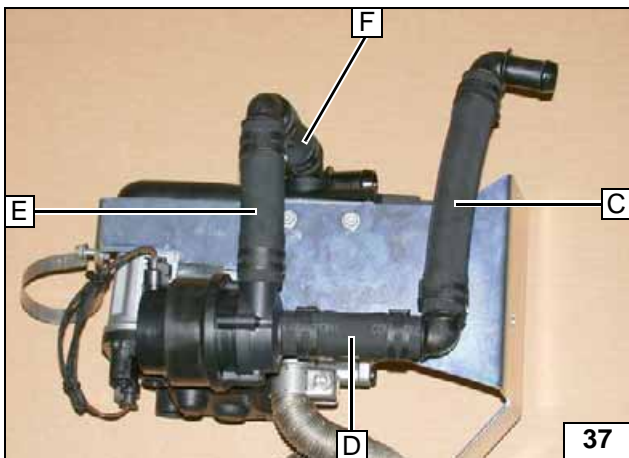

All connecting pipes = 90° 18x18mm dia. [3x], all spring clips = 25mm dia. [8x]!



**Premounting hoses**

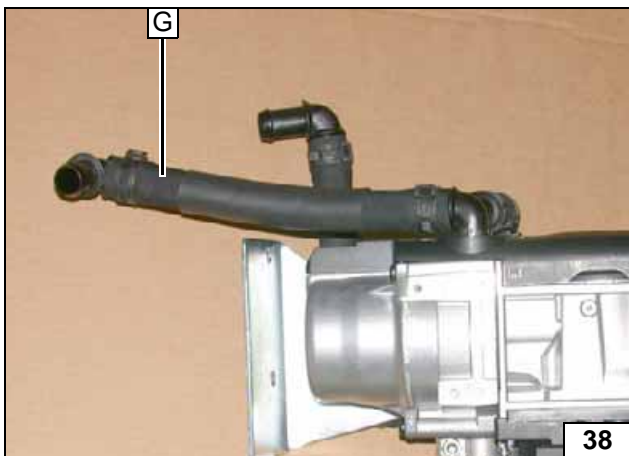

Connecting pipe = 90° 18x18mm dia., all spring clips = 25mm dia. [2x]!



**Premounting hoses**

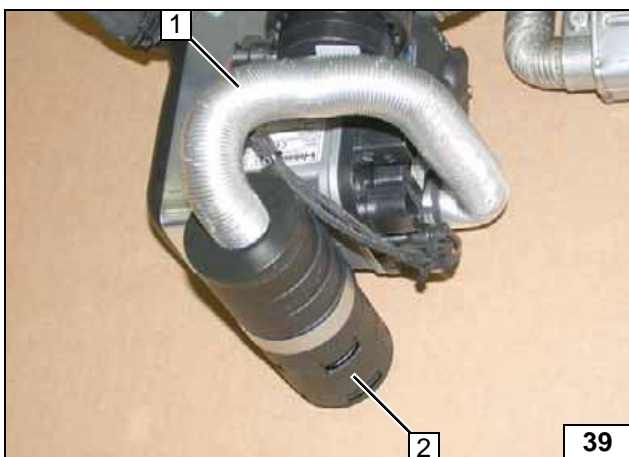

Tighten bolt of 51mm dia. clamp.

- 1** Combustion air pipe
- 2** Combustion air silencer



**Premounting combustion air silencer**

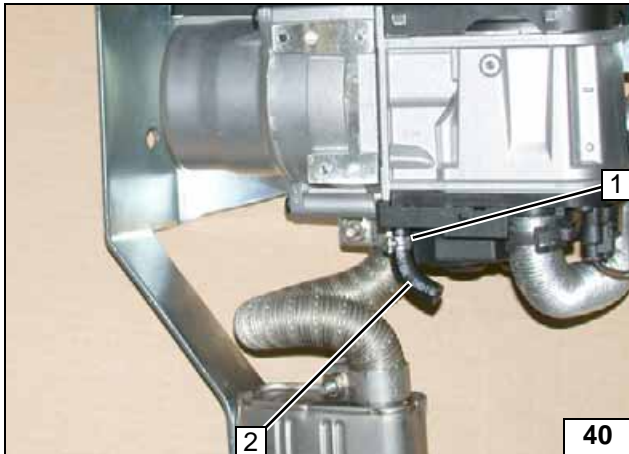
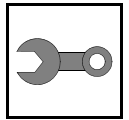

- 1 10 mm dia. clamp
- 2 90° moulded hose

Mounting  
moulded  
hose on  
heater

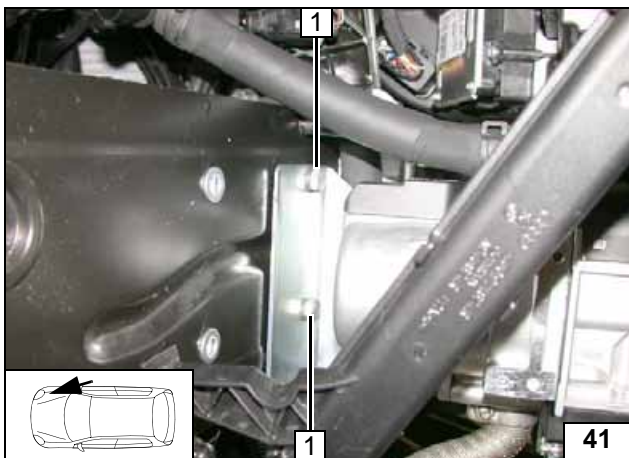

**Installing Heater**

- 1 M8x20 bolt, spring lockwasher [2x each]

Installing  
Heater

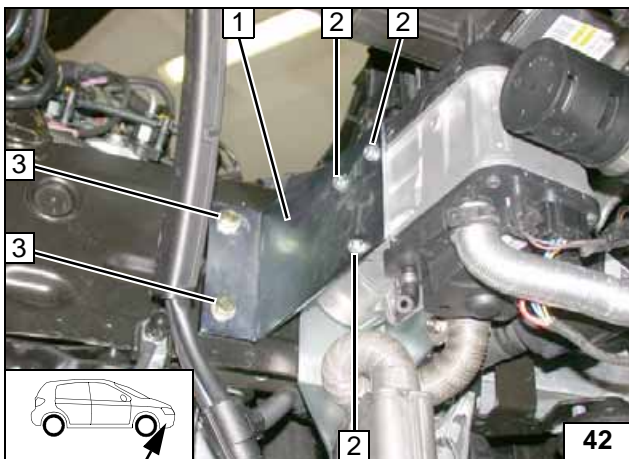

- 1 Bracket part **B**
- 2 Self-tapping bolt 5x13 [3x]
- 3 M8x20 bolt, spring lockwasher [2x]

Installing  
Heater



- 1 Wiring harness of heater [2x]

Attaching  
wiring har-  
ness to  
heater



### Coolant Circuit 2.0 TDI

**WARNING!**

Any coolant running off should be collected using an appropriate container. Install hoses so that they are kink-free. Unless specified otherwise, always fasten using cable ties. Position clamps so that other hoses cannot be damaged. The heater must be filled with coolant when installing the hoses. The connection should be modelled on an "inline" circuit and based on the following diagram:

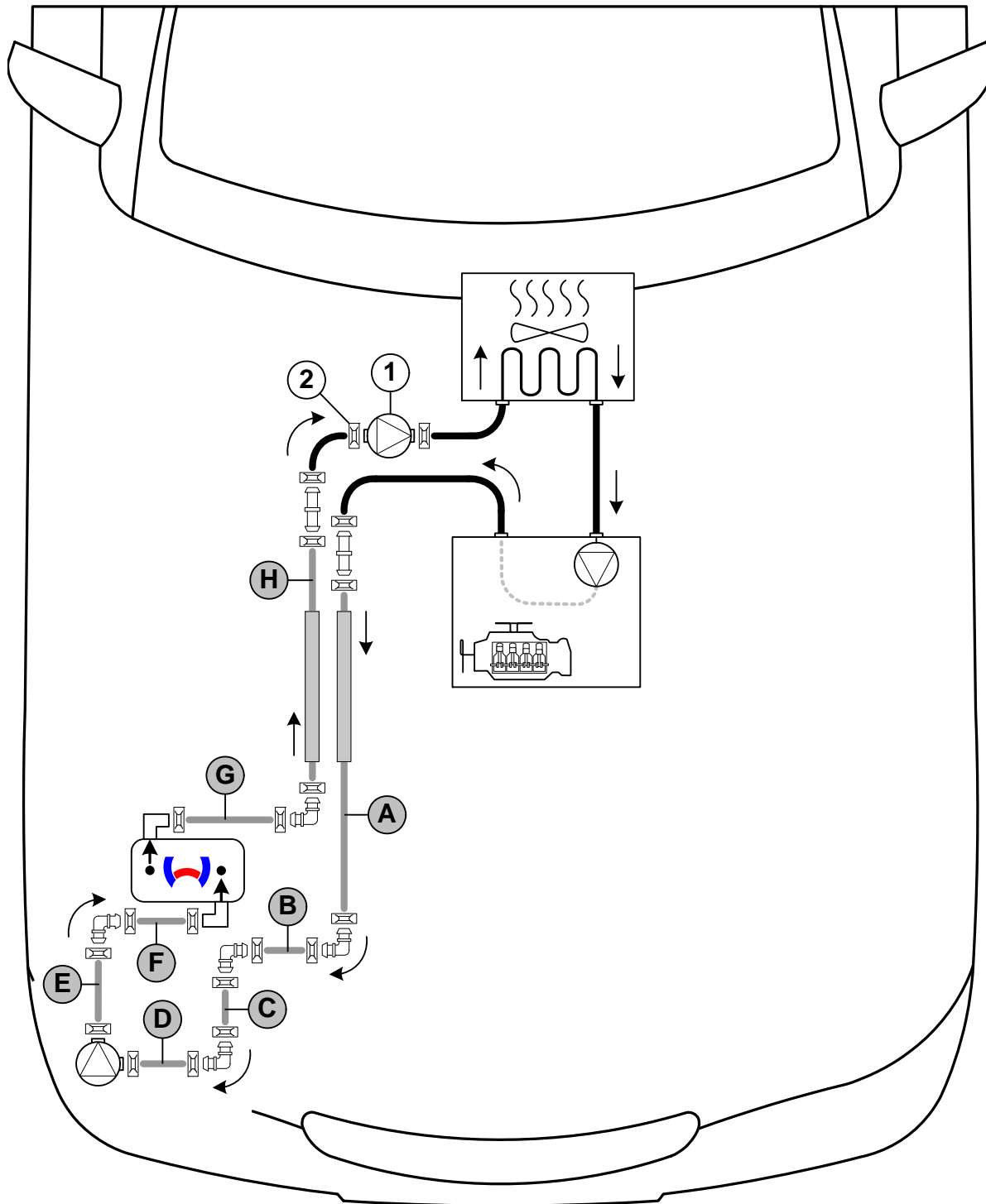



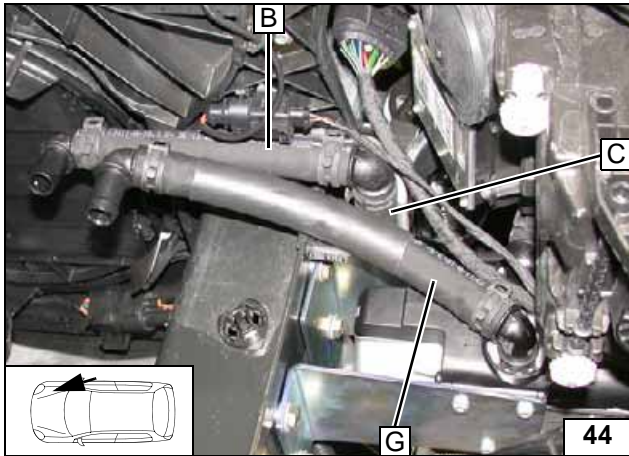

Diagram of hose routing

All spring clips without a specific designation  = 25 mm dia.  
 1 = Original vehicle circulating pump 2 = Original vehicle spring clip .  
 All connecting pipes  and  = 18x18 mm dia.





Routing in engine compartment

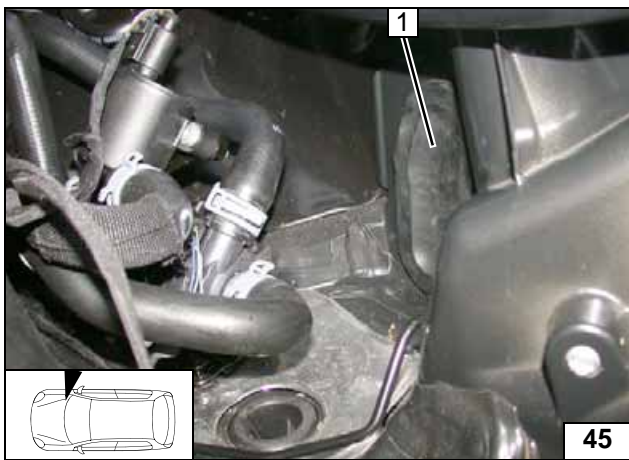

1 Protective rubber plug

Removing protective rubber plug

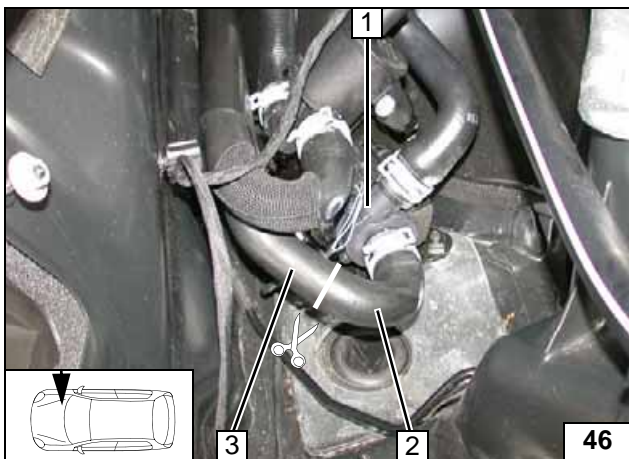

Cut off hose of original vehicle circulating pump / engine outlet at marking. Turn original vehicle hose section on circulating pump inlet 2 about 180° forward.



1 Original vehicle circulating pump  
3 Hose section on engine outlet

Cutting point

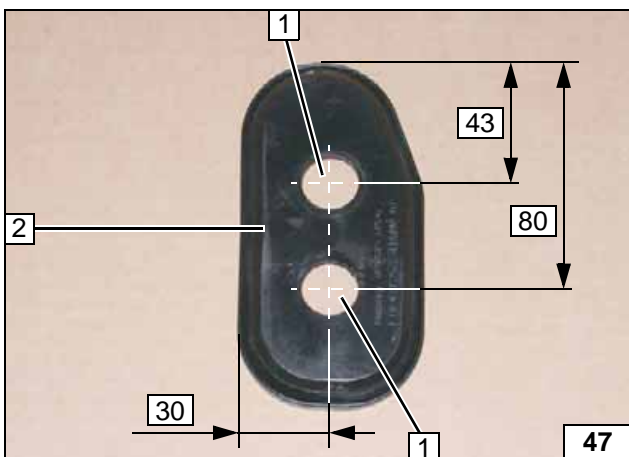

1 Punch in 25 mm dia. hole [2x]  
2 Protective rubber plug

Preparing protective rubber plug

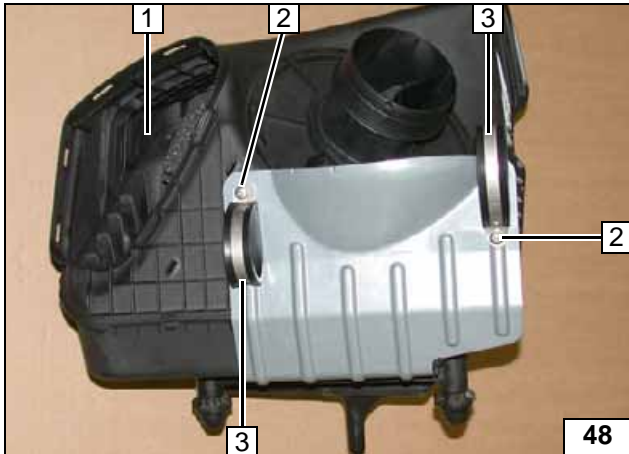

Remove and discard original vehicle bolts at position 2.

- 1 Air filter box
- 2 5.5x13 self-tapping screw [2x each]
- 3 48 mm dia. rubber-coated p-clamp [2x]



**Installing p-clamps**

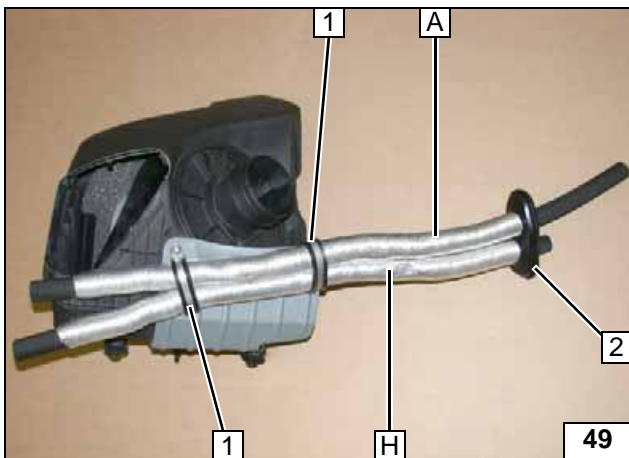

Cut heat protection hose in middle. Push one end each onto hoses **A** and **H** and route using rubber-coated p-clamps **1**. Push protective rubber plug **2** onto both hoses.



**Premounting hose A and H**

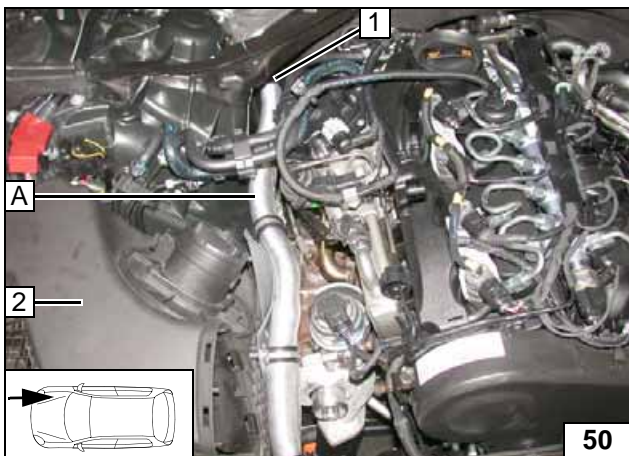

Mount air filter box **2**. Route hoses **A** and **H** (below hose **A**, hidden) through original vehicle pass through into the coolant reservoir!



**Routing in engine compartment**

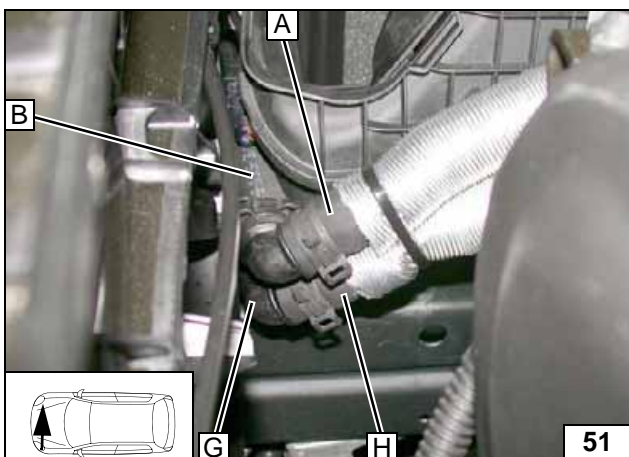

**Connecting hoses**

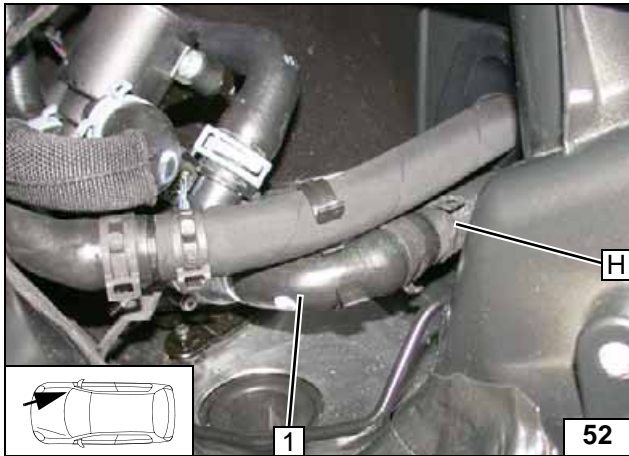

1 Hose section of circulating pump inlet

Connect-  
ing heat ex-  
changer  
inlet

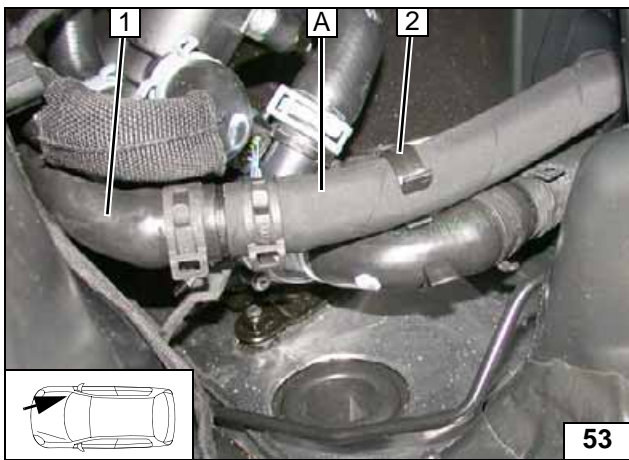

1 Hose section on engine outlet  
2 Spacer bracket

Connect-  
ing engine  
outlet

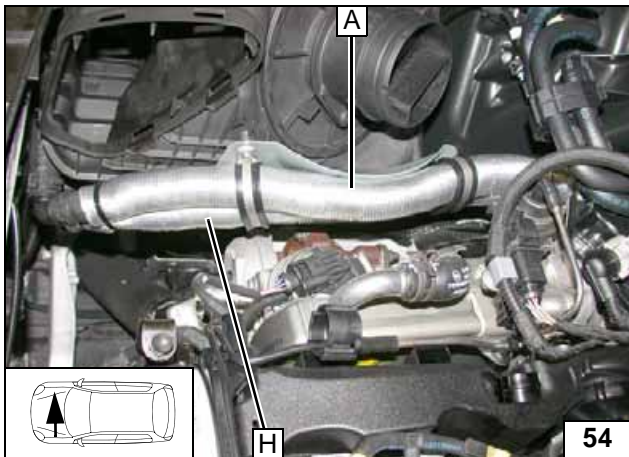

Ensure sufficient distance to neighbouring components, adjust, if necessary.



Aligning  
hoses



### Coolant Circuit 3.0 TDI

**WARNING!**

Any coolant running off should be collected using an appropriate container. Install hoses so that they are kink-free. Unless specified otherwise, always fasten using cable ties. Position clamps so that other hoses cannot be damaged. The heater must be filled with coolant when installing the hoses. The connection should be modelled on an "inline" circuit and based on the following diagram:

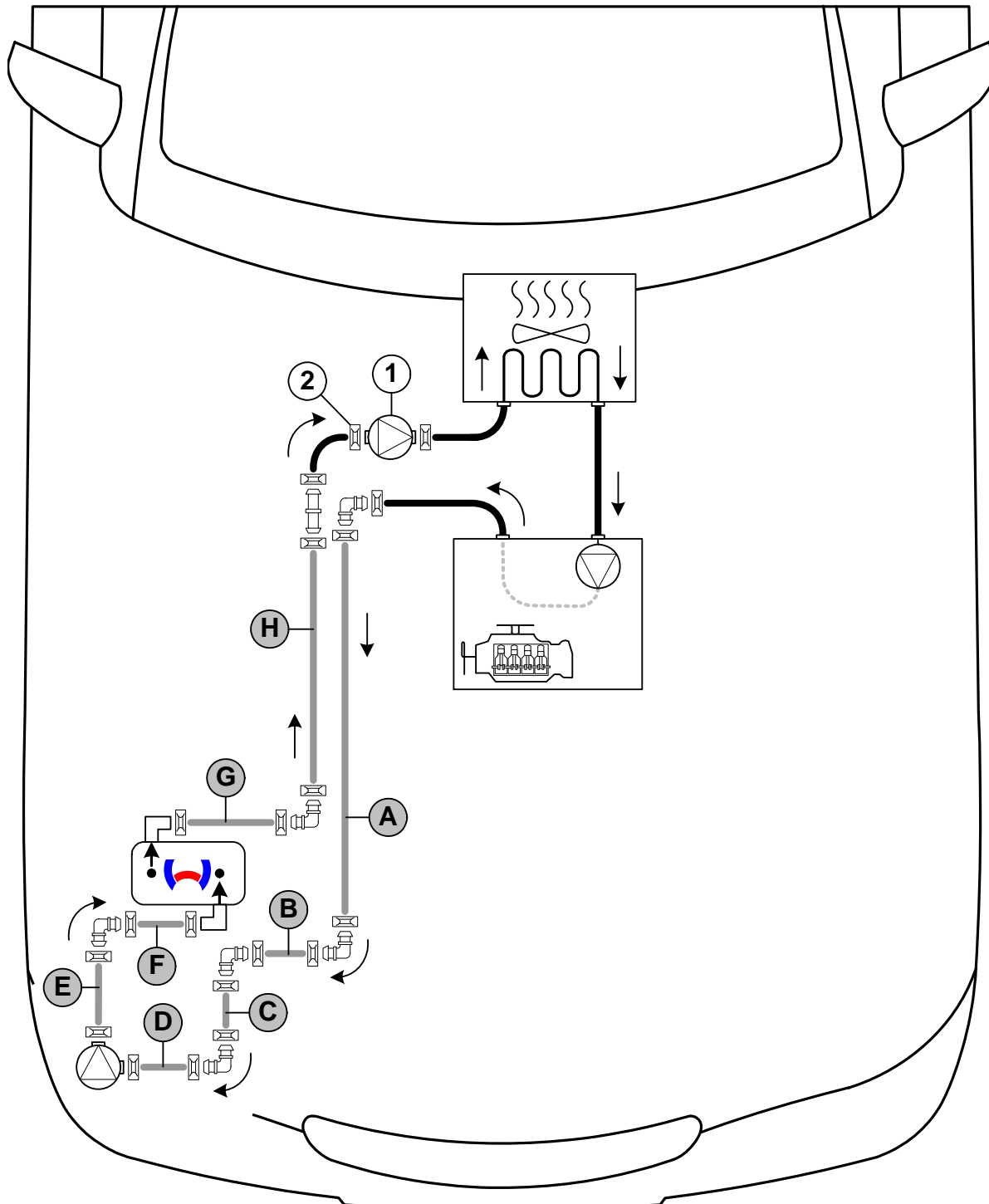



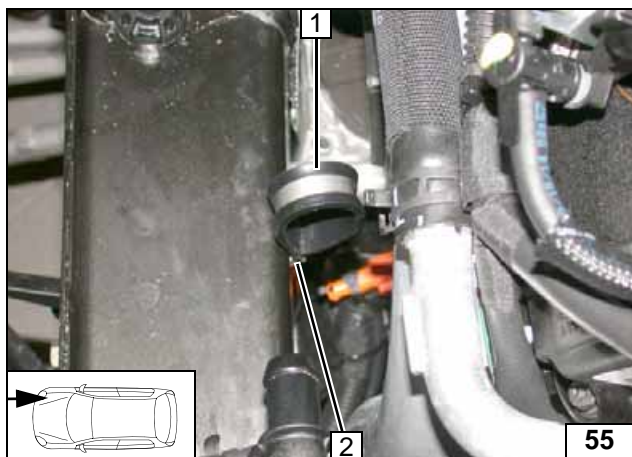

Diagram of hose routing

All spring clips without a specific designation  = 25 mm dia.  
 1 = Original vehicle circulating pump 2 = Original vehicle spring clip .  
 All connecting pipes  and  = 18x18 mm dia.





- 1 38 mm dia. rubber-coated p-clamp
- 2 M6x20 bolt, existing threaded hole

Installing p-clamp

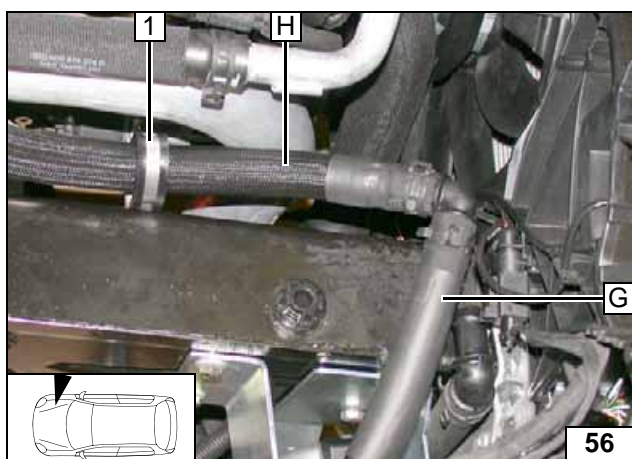

Route hose H through rubber-coated p-clamp 1.



Connect-  
ing heater  
outlet

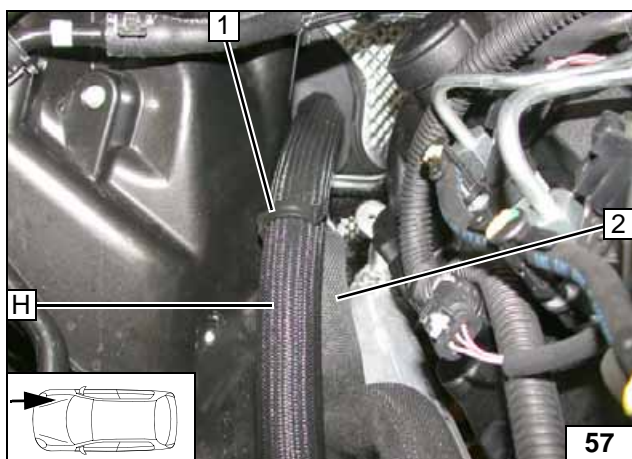

- 1 Insert hose bracket
- 2 Original vehicle hose

Routing in  
engine  
compartment

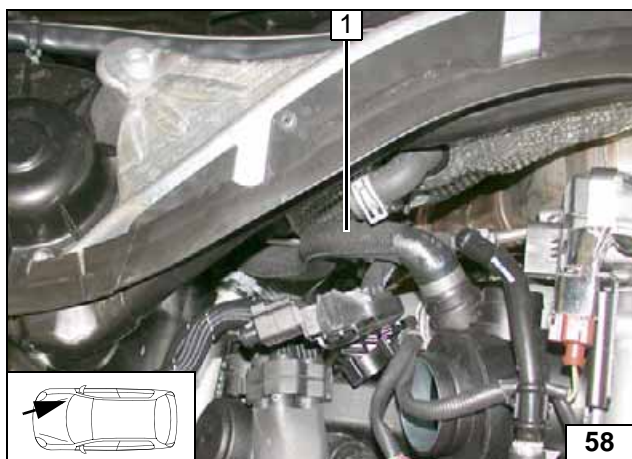

**3.0 TDI quattro 180kW**

Remove hose 1 of engine outlet/original vehicle circulating pump. Spring clip on circulating pump will be reused.



Cutting  
point



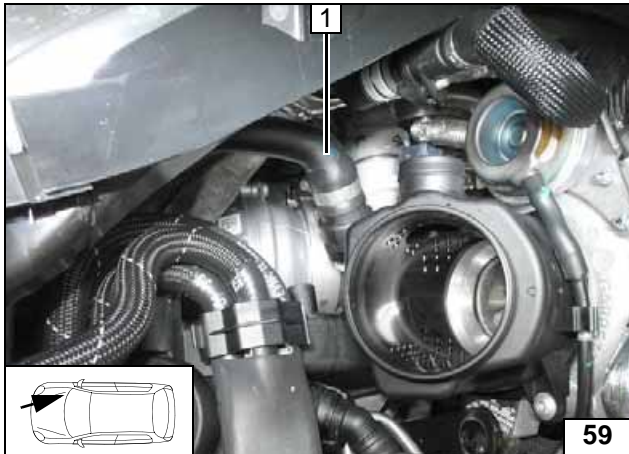

**3.0 TDI quattro 235kW**

Remove hose 1 of engine outlet/original vehicle circulating pump. Spring clip on circulating pump will be reused.



**Cutting point**

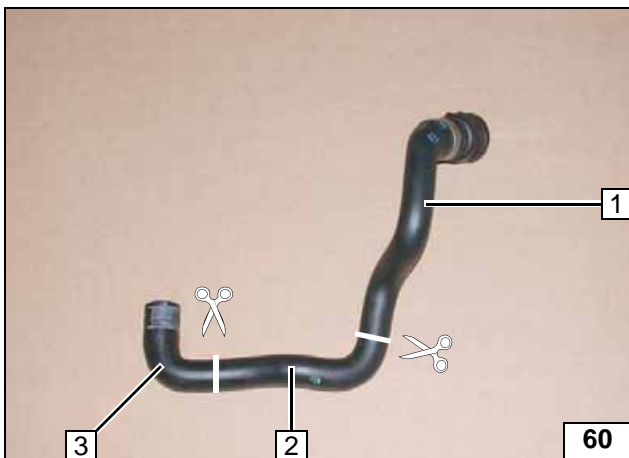

**All vehicles**

Protective hose removed. Cut off hose at markings.

- 1 Hose section on engine outlet
- 2 Discard hose section
- 3 Original vehicle circulating pump hose section



**Cutting point**

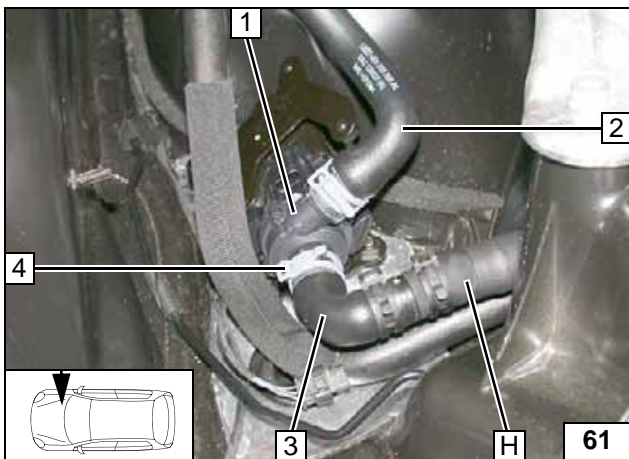

- 1 Original vehicle circulating pump
- 2 Hose on heat exchanger inlet
- 3 Original vehicle hose
- 4 Original vehicle spring clip

**Connect-  
ing heat ex-  
changer  
inlet**

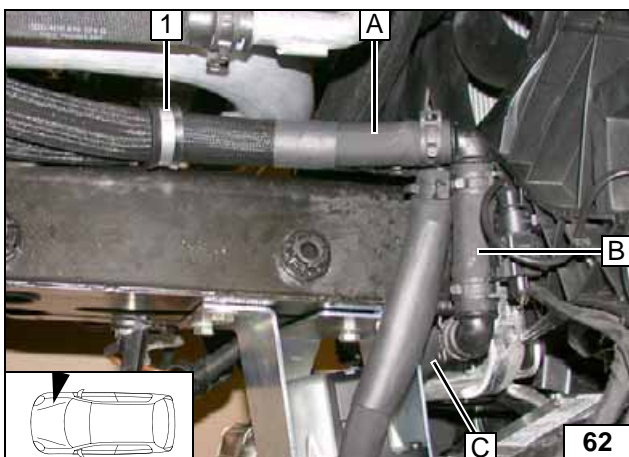

Route hose A through rubber-coated p-clamp 1.



**Connect-  
ing heater  
inlet**

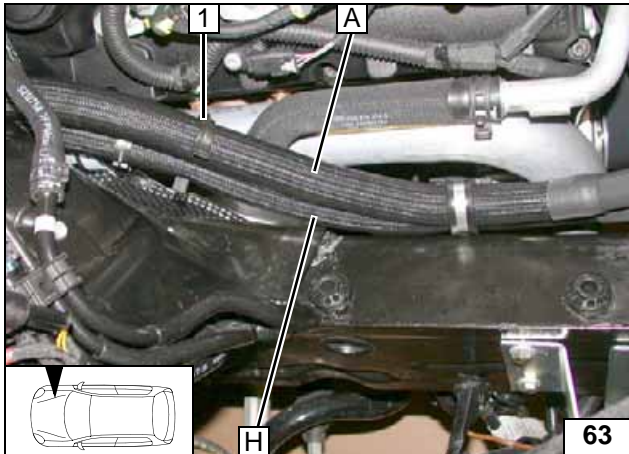

1 Insert hose bracket

Routing in engine compartment

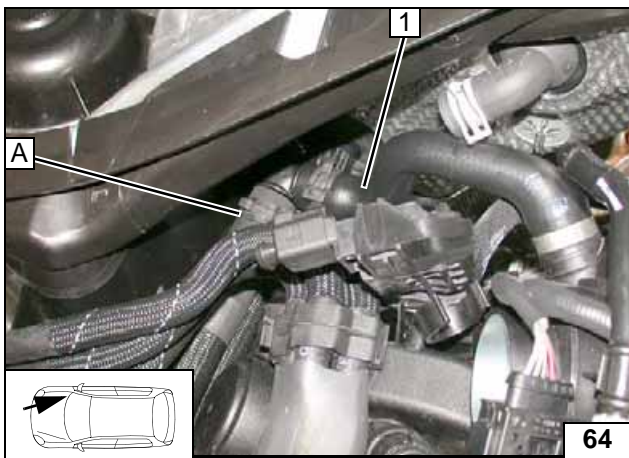

3.0 TDI quattro 180kW

1 Hose section on engine outlet

Connect-  
ing engine  
outlet

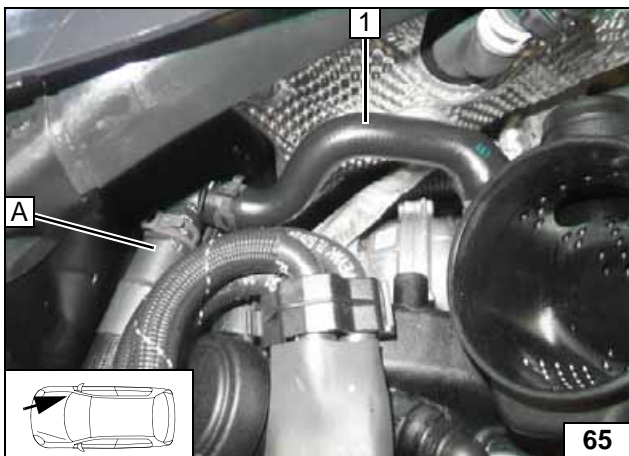

3.0 TDI quattro 235kW

1 Hose section on engine outlet

Connect-  
ing engine  
outlet

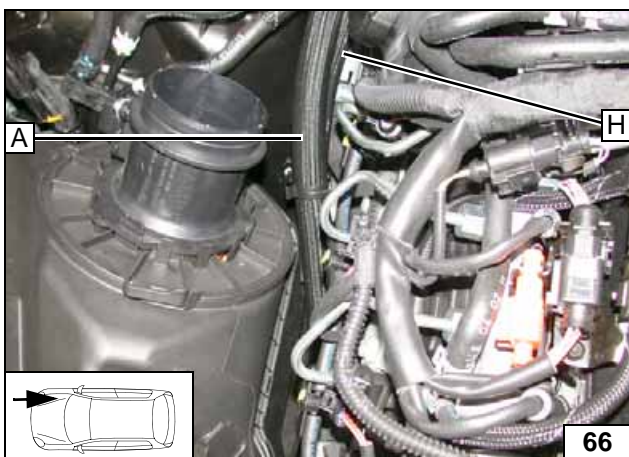

All vehicles

Ensure sufficient distance to neighbouring components, adjust, if necessary.



Aligning  
hoses



**Fuel**

**CAUTION!**

Open the vehicle's fuel tank cap, ventilate the tank and then re-close the tank lock.

Catch any fuel running off in an appropriate container.

Install fuel line and metering pump wiring harness so that they are protected against stone impact. Unless specified otherwise, always fasten using cable ties. Provide rub protection for fuel line and wiring harness in areas where there are sharp edges.

**WARNING!**

The fuel line and wiring harness are routed to the metering pump as shown in the wiring harness routing diagram.

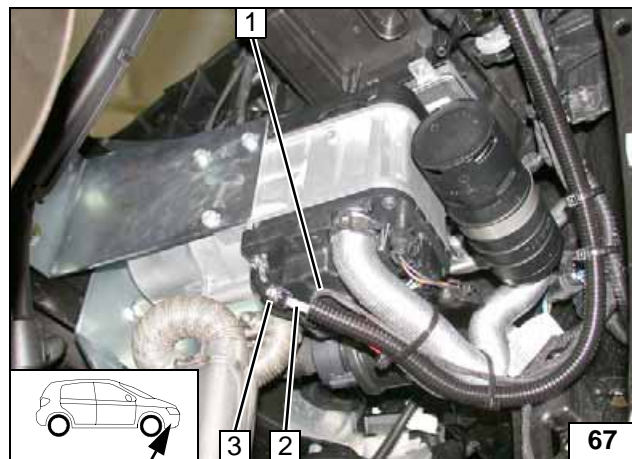

Pull fuel line **2** and wiring harness of metering pump **1** into corrugated tube.

**3** 10 mm dia. clamp

**Connecting heater**

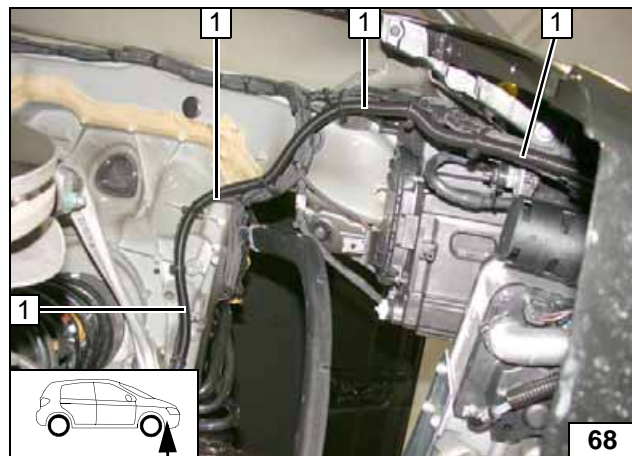

Route fuel line and wiring harness of metering pump into corrugated tube **1** in the right-hand wheel well to the line duct.

**Installing lines**

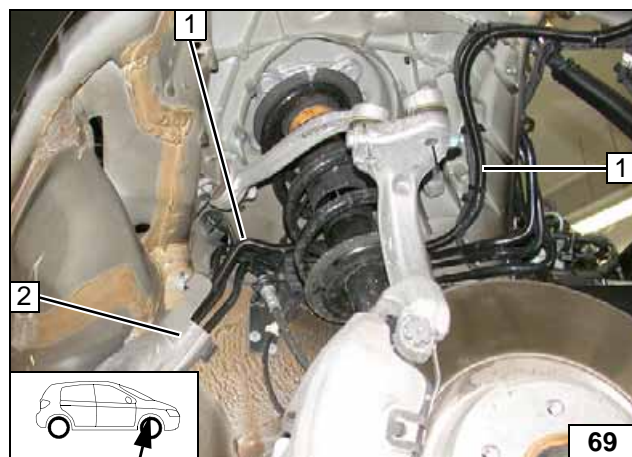

Route fuel line and wiring harness of metering pump into corrugated tube **1** through original vehicle cable duct **2** to the underbody.

**Installing lines**



Route fuel line and wiring harness of metering pump in corrugated tube **1** on original vehicle fuel lines to the installation location of the metering pump.



**Installing lines**

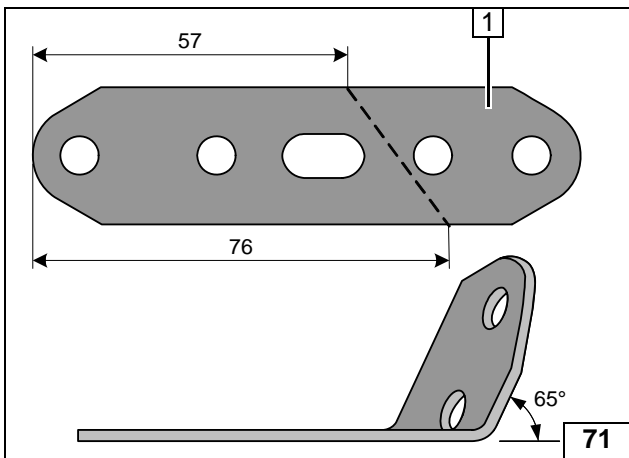

**1** Perforated bracket



**Angling down perforated bracket**

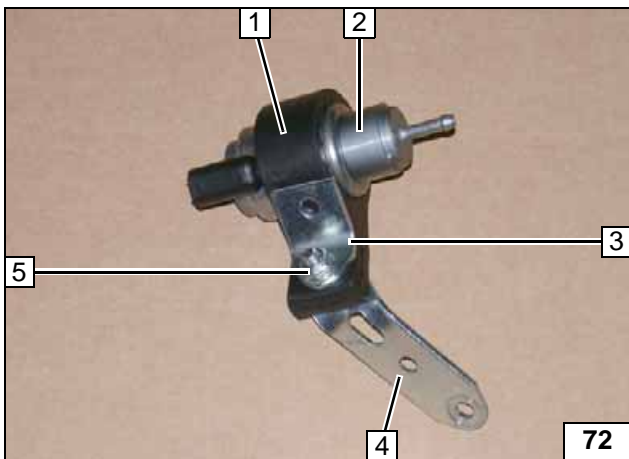

- 1** Mounting of metering pump
- 2** Metering pump
- 3** Support angle bracket
- 4** Perforated bracket
- 5** M6x25 bolt, flanged nut

**Premounting metering pump**

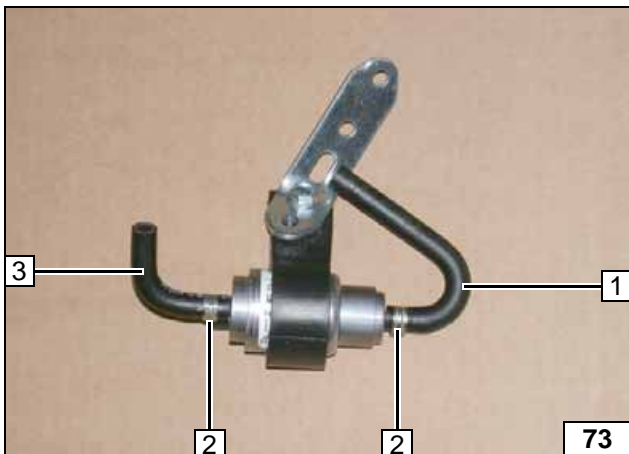

- 1** 180° moulded hose
- 2** 10 mm dia. clamp [2x]
- 3** 90° moulded hose

**Premounting metering pump**

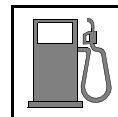

Installing metering pump



- 1 M6x20 bolt, large diameter washer, flanged nut in existing hole
- 2 Perforated bracket

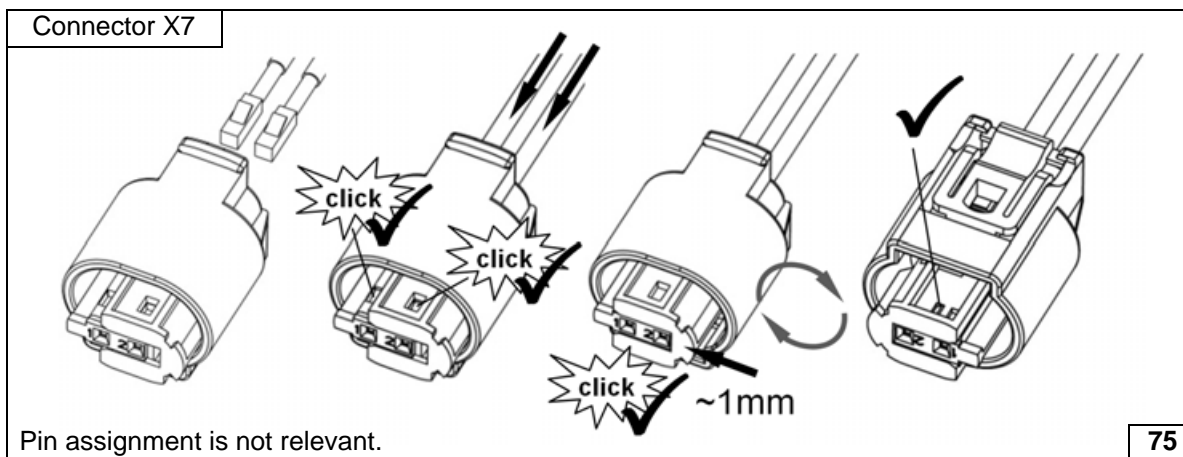

Connector X7

Pin assignment is not relevant.

Completing connector of metering pump

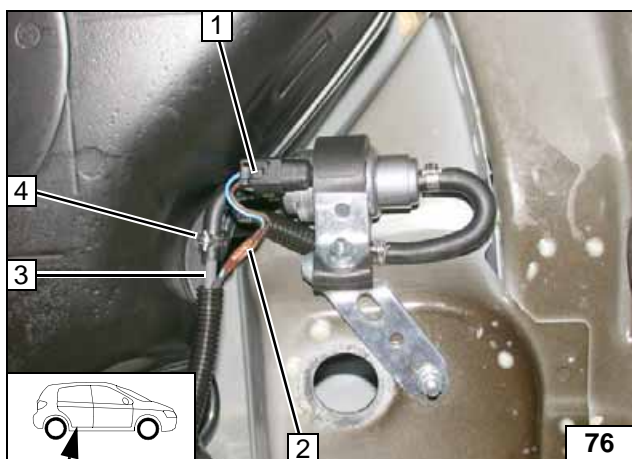

Connect wiring harness of metering pump as well as blue (bl) and brown (br) wires (each 100mm long) 2 from metering pump connector 1 with butt connector so that the wires of the same colour are connected.

- 1 Connector mounted
- 3 Fuel line of heater
- 4 10 mm dia. clamp



Connecting metering pump

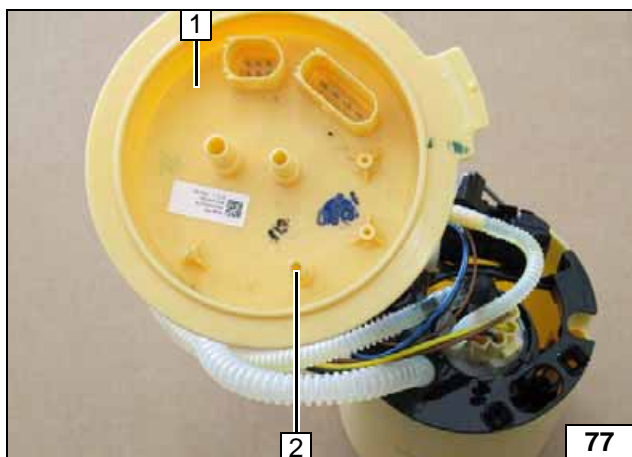

Remove fuel-tank sending unit 1 in accordance with manufacturer's instructions. Drill out connection piece 2 to 2.5 mm dia.



Fuel extraction

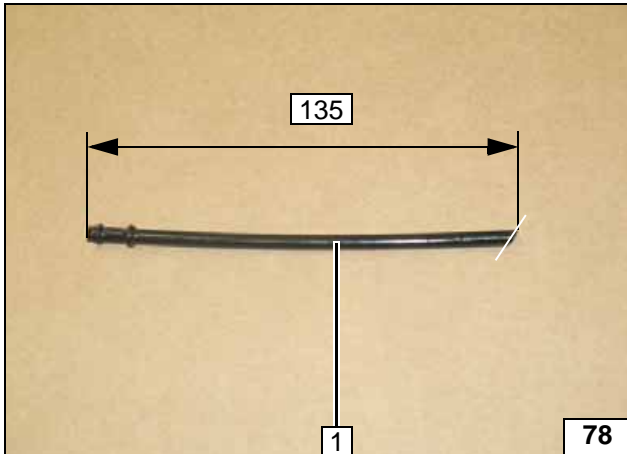
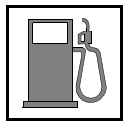

Cut standpipe 1 to length at the end at an angle.



**Cutting fuel standpipe to length**

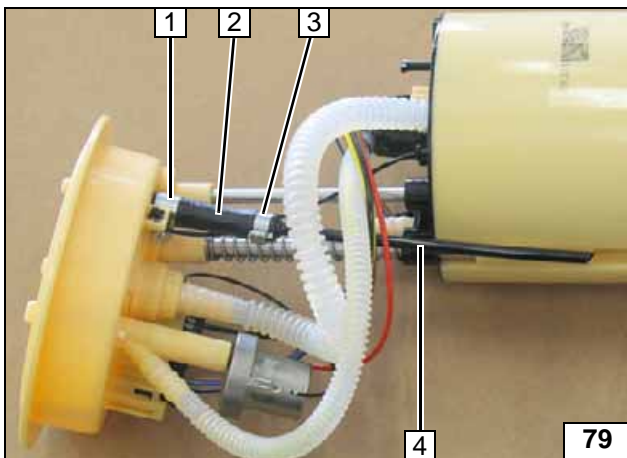

- 1 10 mm dia. hose clamp
- 2 Hose section
- 3 10 mm dia. Caillau clamp
- 4 Standpipe



**Installing fuel standpipe**

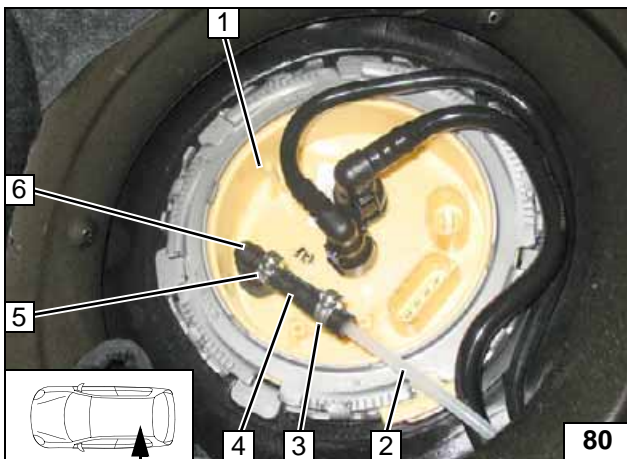

Install fuel-tank sending unit 1 according to manufacturer's instructions.

- 2 Fuel line, fuel standpipe
- 3 10 mm dia. Caillau clamp
- 4 3.5x4.5 mm dia. moulded hose
- 5 8 mm dia. Caillau clamp
- 6 Coupling piece



**Connecting fuel line**

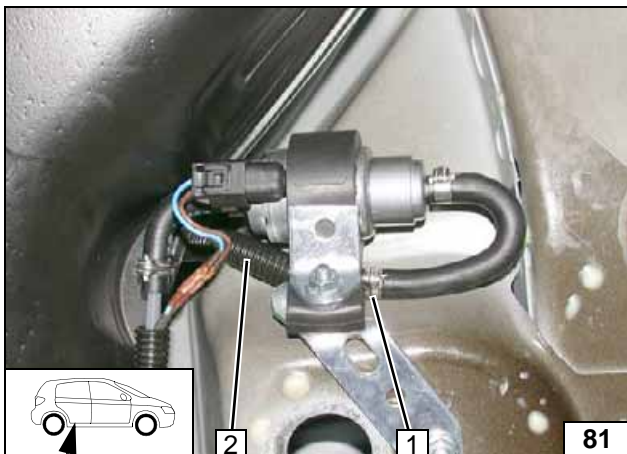

Check the position of the components; adjust if necessary. Check that they have freedom of movement.

- 1 10 mm dia. clamp
- 2 Fuel line in corrugated tube



**Connecting metering pump**

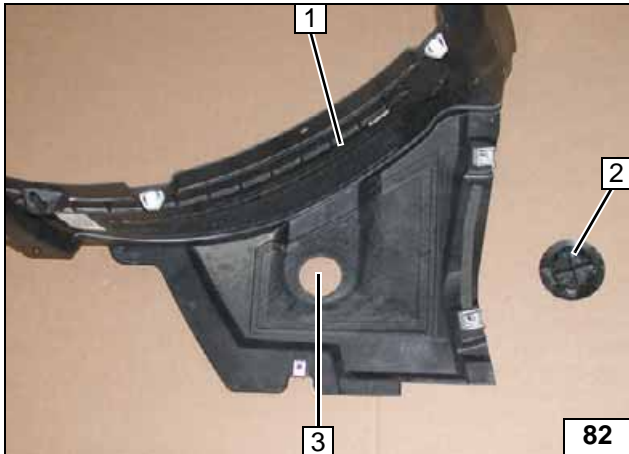
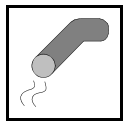

### Exhaust Gas

Remove covering cap 2 at position 3.

- 1 Underride protection



Removing cover cap

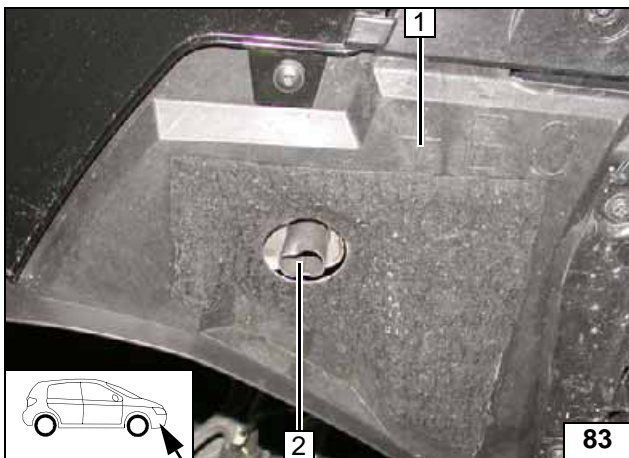

Centrally position exhaust end section 2 in hole.

- 1 Underride protection mounted



Aligning exhaust end section

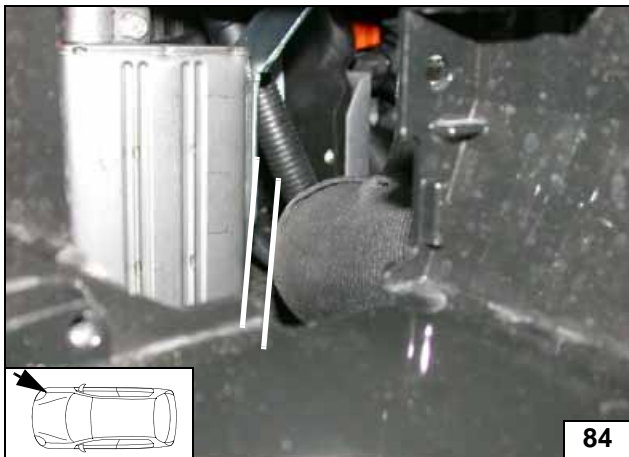

Ensure sufficient distance to neighbouring components, adjust, if necessary.



Aligning silencer



## Final Work

### WARNING!

Reassemble the disassembled components in reverse order. Check all hoses, clamps and all electrical connections for firm seating. Insulate and tie back all loose lines. Only use manufacturer-approved coolant. Spray the heater components with anti-corrosion wax (Tectyl 100K, Order No. 111329).



- **Connect the battery**
- **Fill and bleed the coolant circuit according to the vehicle manufacturer's specifications**
- **Program MultiControl CAR, teach Telestart transmitter**
- **Make settings on A/C control panel according to the "Operating Instructions for End Customer".**
- **Place the "Switch off parking heater before refuelling" caution label in the area of the filler neck.**
- **For initial start-up and function check, see installation instructions.**



## Adaptation of Climatronic J255 Control Unit

with VAS-VCDS

Function:

- Control unit selection
- 08 AC-heater electronics
- Adaptation > „activate retrofit parking heater without CAN“

Save

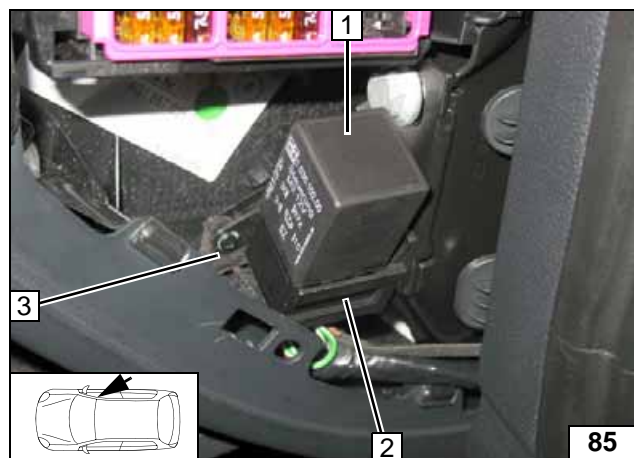

### Only if installing time-delay relay

Align relay socket 2 with glove compartment trim and glove compartment cap lever 3.

- 1 Time-delay relay mounted



Aligning time-delay relay socket

Webasto Thermo & Comfort SE  
Postfach 1410  
82199 Gilching  
Germany  
Internet: [www.webasto.com](http://www.webasto.com)  
Technical Extranet:  
<http://dealers.webasto.com>



## Operating Instructions for End Customer

Please remove page and add to the vehicle operating instructions.

### Note:

We recommend matching the heating time to the driving time.

Heating time = driving time

### Example:

For a driving time of approx. 20 min. (in one direction), we recommend not exceeding a switch-on time of 20 min.

Passenger compartment monitoring, if installed, must be deactivated in addition to the vehicle settings for the heating operation .

Please refer to the Operating Manual of the vehicle for instructions concerning the deactivation.

Before parking the vehicle, make the following settings:



- 1 Set temperature on both sides to "HI"
- 2 Air outlet to windscreen

A/C control panel

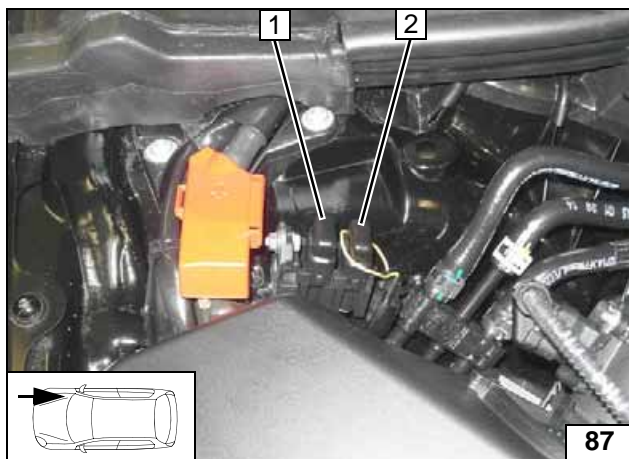

- 1 1A passenger compartment main fuse F2
- 2 20A heater fuse F1

Fuses of engine compartment

