

Water Heater

Thermo Top Evo Parking Heater



Installation Documentation Citroen Berlingo / Peugeot

Validity

Manufacturer	Model	Type	EG-BE No. / ABE
Citroen	Berlingo	7	e2 * 2001 / 116 * 0365* ...
Peugeot	Partner	7	e2 * 2001 / 116 * 0365* ...

Motorisation	Fuel	Transmission type	Output in kW	Displacement in cm ³	Engine code
1.6 VTI	Petrol	SG	72	1598	5F01

SG = Manual transmission

From Model Year 2013
Left-hand drive vehicle

Verified equipment variants: Automatic air-conditioning
Front fog lights

Not verified: Manual air-conditioning
Passenger compartment monitoring

Total installation time: approx. 8.5 hours

Table of Contents

Validity	1	Preparing Installation Location	15
Necessary Components	2	Preparing Heater	16
Installation Overview	2	Installing Heater	18
Information on Total Installation Time	2	Coolant Circuit	20
Information on Operating and Installation Instructions	3	Fuel	23
Information on Validity	4	Exhaust Gas	27
Technical Information	4	Final Work	29
Explanatory Notes on Document	4	Template for Fuel Standpipe	30
Preliminary Work	5	Operating Instructions for End Customer	31
Heater Installation Location	5		
Electrical System	8		
Fan Controller	10		
Digital Timer	13		
Remote Option (Telestart)	13		
Remote Option (Thermocall TC3)	14		

Necessary Components

- Basic delivery scope of *Thermo Top Evo* based on price list
- Installation kit for Citroen Berlingo / Peugeot Partner 2013 Petrol: **1321507A**
- Heater control in accordance with price list and upon consultation with end customer
- In case of Telestart, indicator lamp in accordance with price list and in consultation with end customer

Installation instructions:

- Arrange for the vehicle to be delivered with the tank only about ¼ full!
- The installation location of the push button in the case of Telestart or Thermo Call should be confirmed with the end customer.
- When installing a parking heater, we recommend the use of a larger battery for the vehicle.

Installation Overview

Legend:

1. Heater
2. Fuse holder of engine compartment
3. Passenger compartment relay and fuse holder
4. IPCU
5. Circulating pump
6. Digital Timer
7. Metering pump

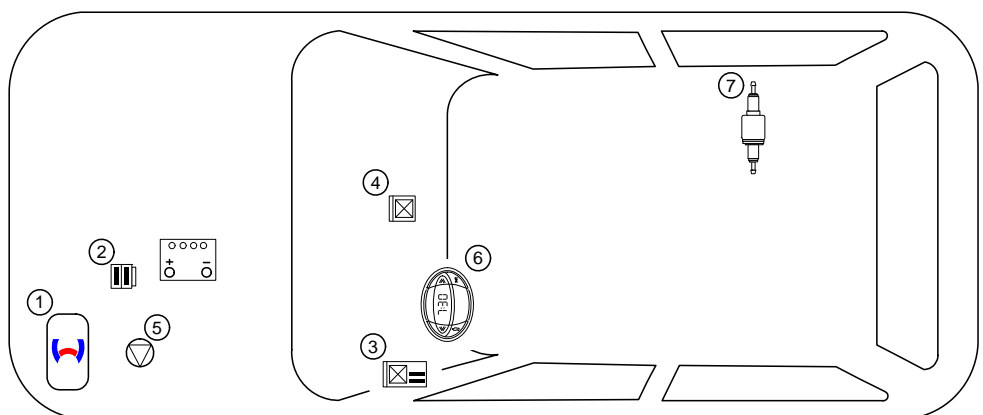

Information on Total Installation Time

The total installation time includes the time needed for mounting and demounting of the vehicle-specific components, the heater specific installation time and all other times required for the system integration and initial start-up of the heater.

The total installation time may vary for vehicle equipment other than provided.

Information on Operating and Installation Instructions

1 Important notes (not complete)

1.1 Installation and repair



The improper installation or repairing of Webasto heating and cooling systems can cause fire or the leakage of deadly carbon monoxide, leading to serious injury or death.



To install and repair Webasto heating and cooling systems you need to have completed a special company training course and have the appropriate technical documentation, special tools and special equipment.



Installation and repair may ONLY be carried out by persons trained and certified in a Webasto training course. NEVER try to install or repair Webasto heating or cooling systems if you have not completed a Webasto training course, you do not have the necessary technical skills and you do not have the technical documentation, tools and equipment available to ensure that you can complete the installation and repair work properly.

Only use genuine Webasto parts. See the Webasto air and water heaters accessories catalogue for this purpose.

1.2 Operation

To ensure safe operation, we recommend having the heater checked every two years by an authorised Webasto dealer, especially when used over a long period and/or under extreme environmental conditions.

Do not operate the heater in closed rooms due to the danger of poisoning and suffocation.

Always switch off the heater before refuelling.

The heater may only be used with the prescribed fuel Diesel (DIN EN 590) or petrol (DIN EN 227).

The heater may not be cleaned with a high-pressure cleaner.

1.3 Please note

ALWAYS follow all Webasto installation and operating instructions and observe all warnings.

To become familiar with and understand all functions and properties of the heater, the operating instructions must be read carefully and observed at all times.

For proper, safe installation and repair work, the installation instructions with all warnings and safety information must be carefully read and observed at all times. Please always contact a workshop authorised by Webasto for all installation and repair work.

Important

Webasto shall assume no liability for defects, damage and injuries resulting from a failure to observe the installation, repair and operating instructions of the information contained in them.

This liability exclusion particularly applies to improper installations and repairs, installations and repairs by untrained persons or in the case of a failure to use genuine spare parts.

The liability due to culpable disregard to life, limb or health and due to damage or injuries caused by a wilful or reckless breach of duty remain unaffected, as does the obligatory product liability.

Installation should be carried out according to the general, standard rules of technology. Unless specified otherwise, fasten hoses, wires and wiring harnesses to original vehicle lines and wiring harnesses using cable ties. Insulate loose wires and tie back. Connectors on electronic components have to audibly click into place during installation.

Sharp edges should be fitted with rub protection. Spray unfinished body areas, e.g. drilled holes, with anti-corrosion wax (Tectyl 100K, Order No. 111329).

Observe the instructions and guidelines of the respective vehicle manufacturer for demounting and mounting vehicle specific components!

The initial startup is to be executed with the Webasto Thermo Test Diagnosis.

When installing an IPCU, the corresponding settings must be checked or adjusted before the installation.

2 Statutory regulations governing installation

Guidelines	Thermo Top Evo
Heating Directive ECE R122	E1 00 0258
EMC Directive ECE R10	E1 03 5627

Note

The regulations of these guidelines are binding in the scope of the Directive 70/156/EEC and/or 2007/46/EC (for new vehicle models from 29/04/2009) and should also be observed in countries in which there are no special regulations.

Important

Failure to follow the installation instructions will result in the invalidation of the type approval for the heater and therefore invalidation of the general **homologation of the vehicle**.

Note

For vehicles with an EU permit, no entry in accordance with § 19 Sub-Section 4 of Annex VIII b to the Road Traffic Act is required.

2.1 Excerpt from the directive 2001/56/EC Appendix VII for the installation of the heater

Beginning of excerpt.

ANNEX VII

REQUIREMENTS FOR COMBUSTION HEATERS AND THEIR INSTALLATION

1. GENERAL REQUIREMENTS

1.7.1. A clearly visible tell-tale in the operator's field of view shall inform when the combustion heater is switched on or off.

2. VEHICLE INSTALLATION REQUIREMENTS

2.1. Scope

2.1.1. Subject to paragraph 2.1.2. combustion heaters shall be installed according to the requirements of this Annex.

2.1.2. Vehicles of category O having liquid fuel heaters are deemed to comply with the requirements of this Annex.

2.2. Positioning of heater

2.2.1. Body sections and any other components in the vicinity of the heater must be protected from excessive heat and the possibility of fuel or oil contamination.

2.2.2. The combustion heater shall not constitute a risk of fire, even in the case of overheating. This requirement shall be deemed to be fulfilled if the installation ensures an adequate distance to all parts and suitable ventilation, by the use of fire resistant materials or by the use of heat shields.

2.2.3. In the case of M2 and M3 vehicles, the heater must not be positioned in the passenger compartment. However, an installation in an effectively sealed envelope which also complies with the conditions in paragraph 2.2.2 may be used.

2.2.4. The label referred to in paragraph 1.4 or a duplicate, must be positioned so that it can be easily read when the heater is installed in the vehicle.

2.2.5. Every reasonable precaution should be taken in positioning the heater to minimise the risk of injury and damage to personal property.

2.3. Fuel supply

2.3.1. The fuel filler must not be situated in the passenger compartment and must be provided with an effective cap to prevent fuel spillage

2.3.2. In the case of liquid fuel heaters, where a supply separate to that of the vehicle is provided, the type of fuel and its filler point must be clearly labelled

2.3.3. A notice, indicating that the heater must be shut down before refuelling, must be affixed to the fuelling point. In addition a suitable instruction must be included in the manufacturer's operating manual.

2.4. Exhaust system

2.4.1. The exhaust outlet must be located so as to prevent emissions from entering the vehicle through ventilators, heated air inlets or opening windows.

2.5. Combustion air inlet

2.5.1. The air for the combustion chamber of the heater must not be drawn from the passenger compartment of the vehicle.

2.5.2. The air inlet must be so positioned or guarded that blocking by rubbish or luggage is unlikely.

2.6. Heating air inlet

2.6.1. The heating air supply may be fresh or recirculated air and must be drawn from a clean area not likely to be contaminated by exhaust fumes emitted either by the propulsion engine, the combustion heater or any other vehicle source.

2.6.2. The inlet duct must be protected by mesh or other suitable means.

2.7. Heating air outlet

2.7.1. Any ducting used to route the hot air through the vehicle must be so positioned or protected that no injury or damage could be caused if it were to be touched.

2.7.2. The air outlet must be so positioned or guarded that blocking by rubbish or luggage is unlikely.

End of excerpt.

In multilingual versions the German language is binding.

Citroen Berlingo / Peugeot Partner

Information on Validity

This installation documentation applies to Citroen Berlingo / Peugeot Partner Petrol vehicles - for validity, see page 1 - from model year 2013 and later, assuming technical modifications to the vehicle do not affect installation, any liability claims excluded. Depending on the vehicle version and equipment, modifications may be necessary during installation with respect to these "installation instructions".

Vehicle and engine types, equipment variants and other specifications not listed in this installation documentation have not been tested. However, installation according to this installation documentation may be possible.

Technical Information

Special Tools

- Hose clamp pliers for auto-tightening hose clamps
- Hose clamp pliers for Clic hose clamps of type W
- Automatic wire stripper 0.2 - 6mm²
- Crimping pliers for cable lug / tab connector 0.5 - 6mm²
- Torque wrench for 2.0 - 10 Nm
- Hose clamping pliers
- Metric thread-setter kit
- Webasto Thermo Test Diagnosis with current software

Dimensions

- All dimensions in mm.

Tightening torque values

- Tightening torque values for 5x13 heater bolts and 5x11 heater stud bolts = 8Nm.
- Tightening torque values of 5x15 retaining plate of water connection piece bolts = 7Nm.
- Tighten other bolt connections in accordance with manufacturer's instructions or in accordance with state-of-the-art-technology.

Explanatory Notes on Document

You will find an identification mark on the outside top right corner of the page in question to provide you with a quick overview of the individual working steps.

Special features are highlighted using the following symbols:

Mechanical system



Electrical System



Coolant Circuit

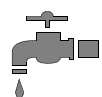

Combustion Air

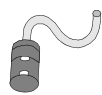

Fuel



Exhaust gas



Software



Special risk of injury or fatal accidents.



Specific risk of damage to components.



Specific risk of fire or explosion.



Reference to general installation instructions of the Webasto component or to vehicle specific documents of the manufacturer



Reference to a special technical feature.



The arrow in the vehicle icon indicates the position on the vehicle and the viewing angle.

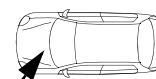

Citroen Berlingo / Peugeot Partner

Preliminary Work

Vehicle

- Open the fuel tank cap.
- Ventilate the fuel tank.
- Close the fuel tank cap again.
- Depressurise the cooling system.
- Disconnect and completely remove the battery with carrier.
- Remove the front left wheel well trim.
- Remove the air filter together with the intake hose.
- Remove the bracket of the air filter (original vehicle bolts will be reused).
- Remove the lower and left instrument panel trim on the driver's side.
- Detach fuel tank and lower back.
- Open the right-hand tank-fitting service lid.
- Remove the fuel-tank sending unit in accordance with the manufacturer's instructions.
- Remove the underride protection.

Heater

- Remove years that do not apply from the type and duplicate label.
- Attach the duplicate label (type label) in the appropriate place in the engine compartment.

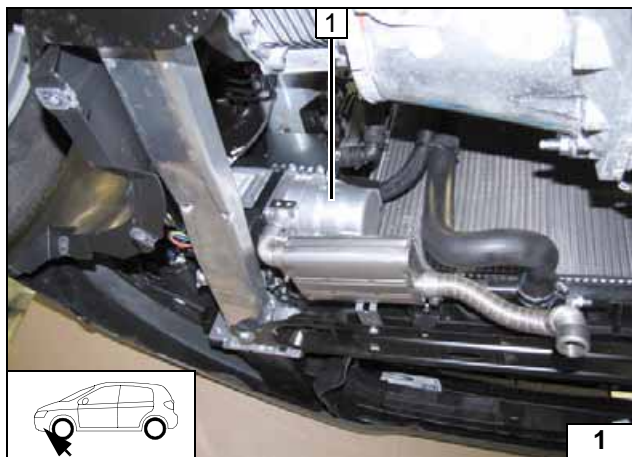

Heater Installation Location

1 Heater

Installation
location

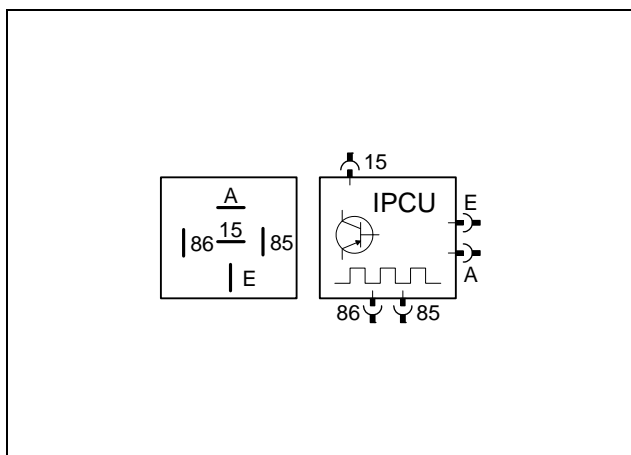
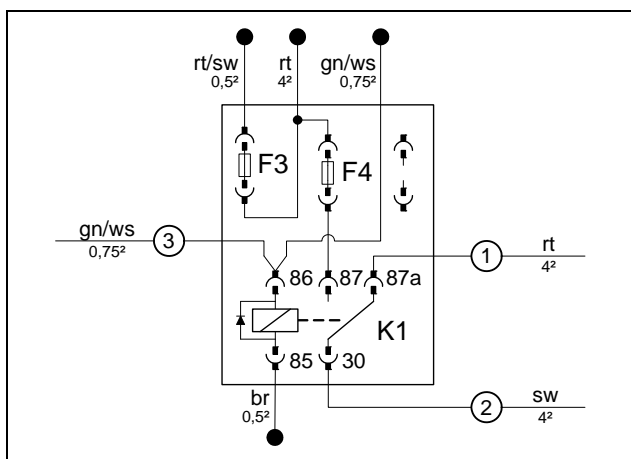
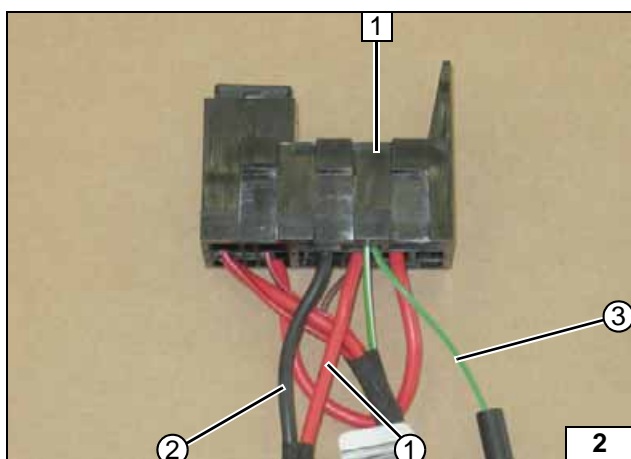
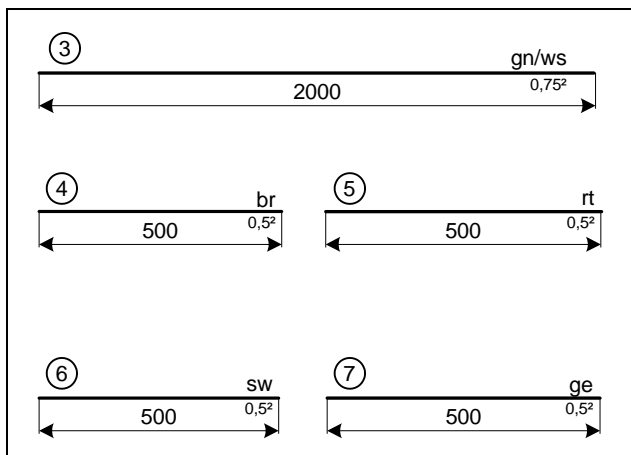

Preparing Electrical System

Wire sections retain their numbering throughout the entire document.



Assigning wires

- 1 Relay and fuse holder of passenger compartment
- ① Red (rt) 4² wire of K1/87a
- ② Black (sw) 4² wire of K1/30
- ③ Green/white (gn/ws) wire of K1/86

Preparing passenger compartment relay and fuse holder

Detach and remove contact of K1/86. Install wires with provided contacts onto socket of K1 relay. Insert 25A fuse F4. K1 relay will only be inserted after installation of relay and fuse holder. Pull green/white (gn/ws) wire ③ into protective sleeving.



Preparing passenger compartment relay and fuse holder

IPCU view on contact side.
The IPCU included in the kit must be programmed with the following settings:



- Duty cycle: 33%
- Frequency: 1000Hz
- Voltage: 5V
- Function: High side

Preparing IPCU

The settings must be checked during start-up of heater and adjusted if necessary.

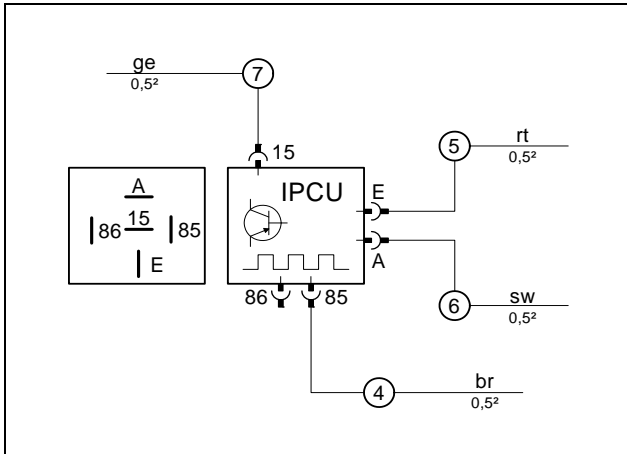

Connect lines to IPCU socket.



Premounting IPCU

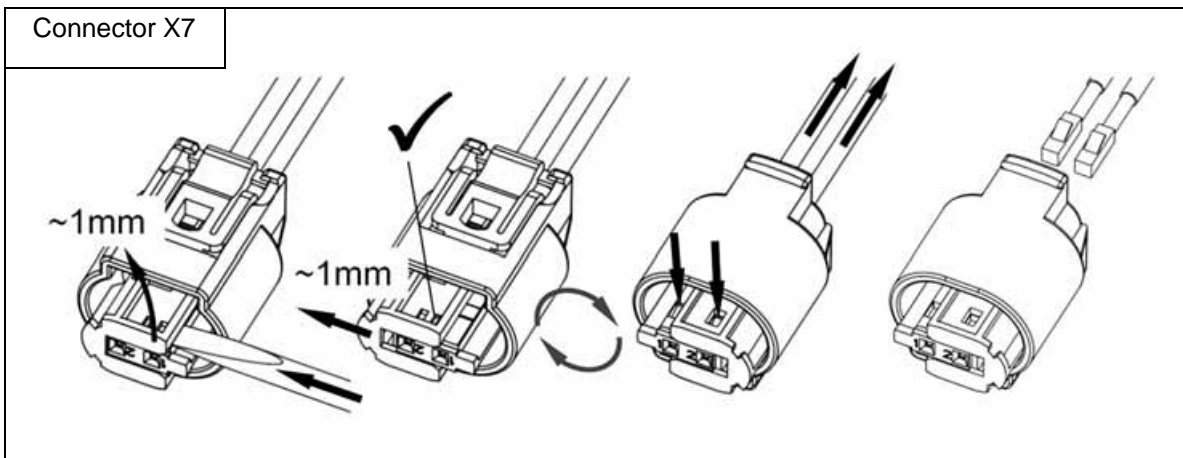

Dismantling connector of metering pump



Electrical System



Earth wire

- 1 Earth wire on original vehicle earth support point

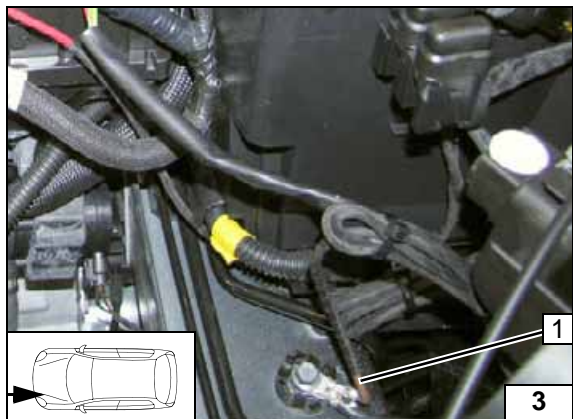

Positive wire

- 1 Positive wire on positive distributor

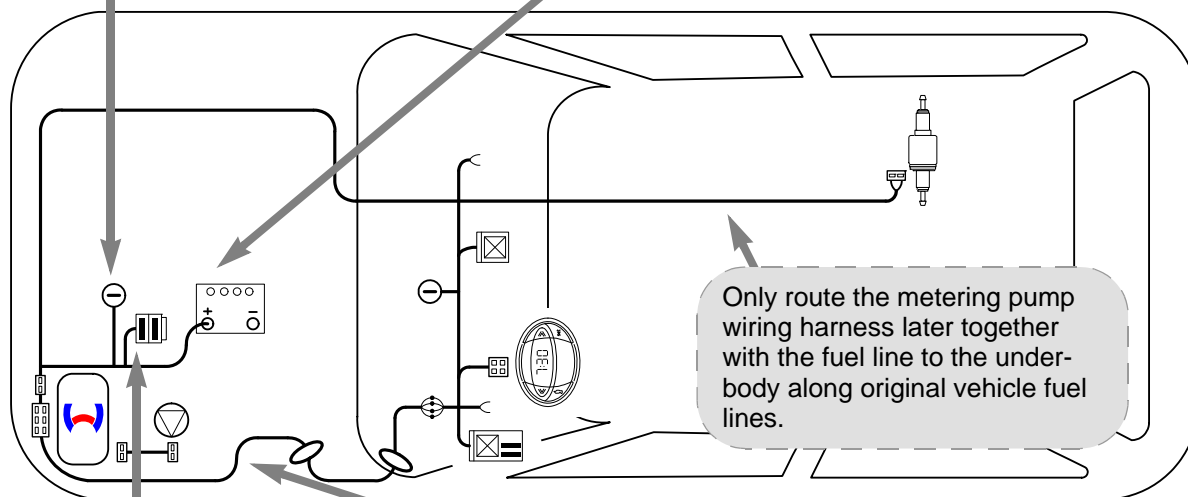
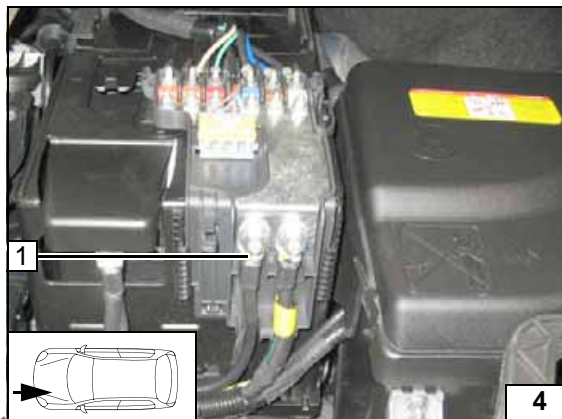

Wiring harness routing diagram

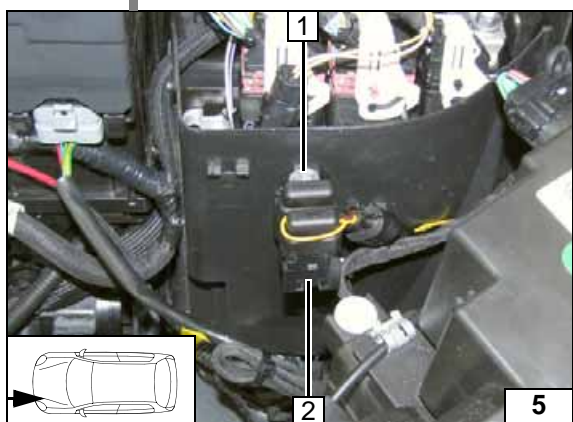

Fuse holder of engine compartment

- 1 5.5 mm dia. hole; M5x16 bolt, washer [2x], retaining plate of fuse holder, nut
- 2 F1-2 fuses

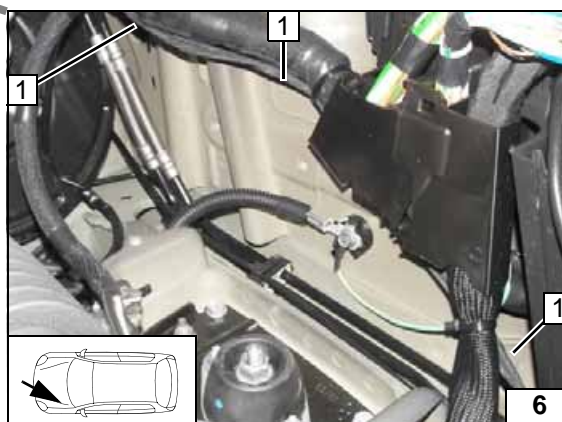

Wiring harness routing in engine compartment

- 1 Wiring harnesses of heater, heater controls

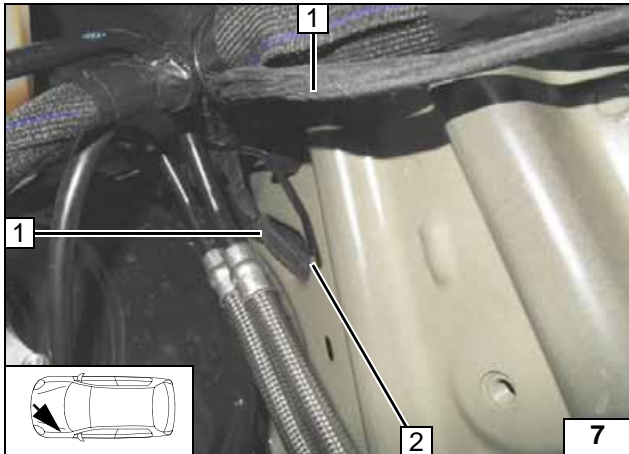

Route wiring harness of heater and heater control **1** into wheel well.

- 2** Wheel well pass through



Routing wiring harnesses

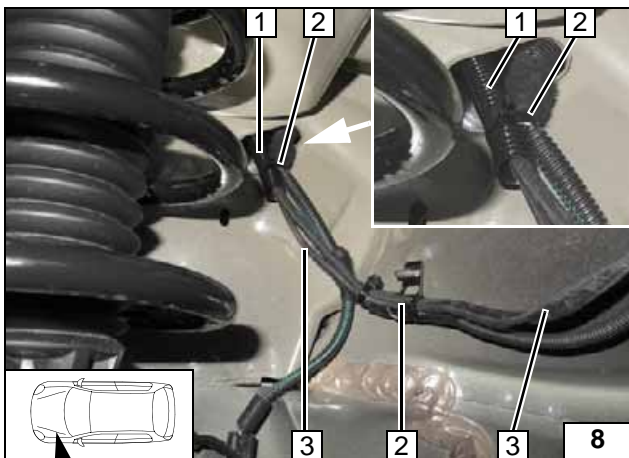

Route wiring harness of heater and heater control **3** along original vehicle wire to A-pillar and fasten.

- 1** 10 mm dia., 100mm long corrugated tube (cut lengthwise)
- 2** Cable tie



Routing wiring harnesses

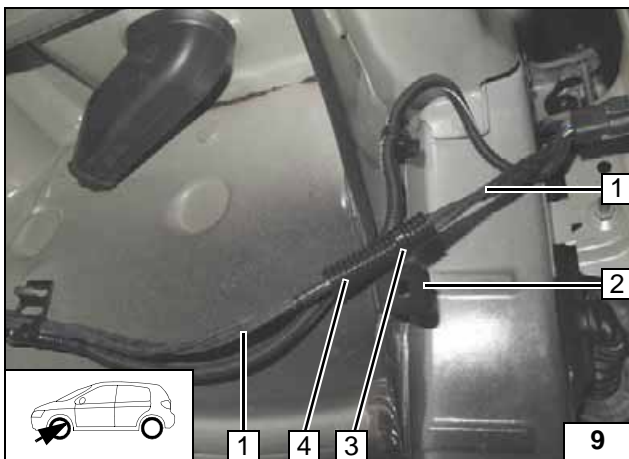

Route wiring harness of heater and heater control **1** along original vehicle wire to A-pillar and fasten.

- 2** Original vehicle tab
- 3** Cable tie
- 4** 10mm dia., 50mm long corrugated tube (cut lengthwise)



Routing wiring harnesses

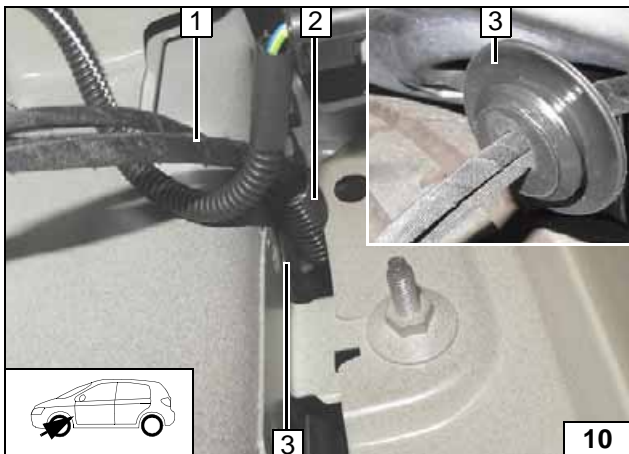

Remove original vehicle pass through **3**, punch through. Pull through wiring harnesses of heater and heater control **1**, lead into passenger compartment and replace the pass through.

- 2** 10mm dia., 50mm long corrugated tube (cut lengthwise)



Routing wiring harnesses



Fan Controller

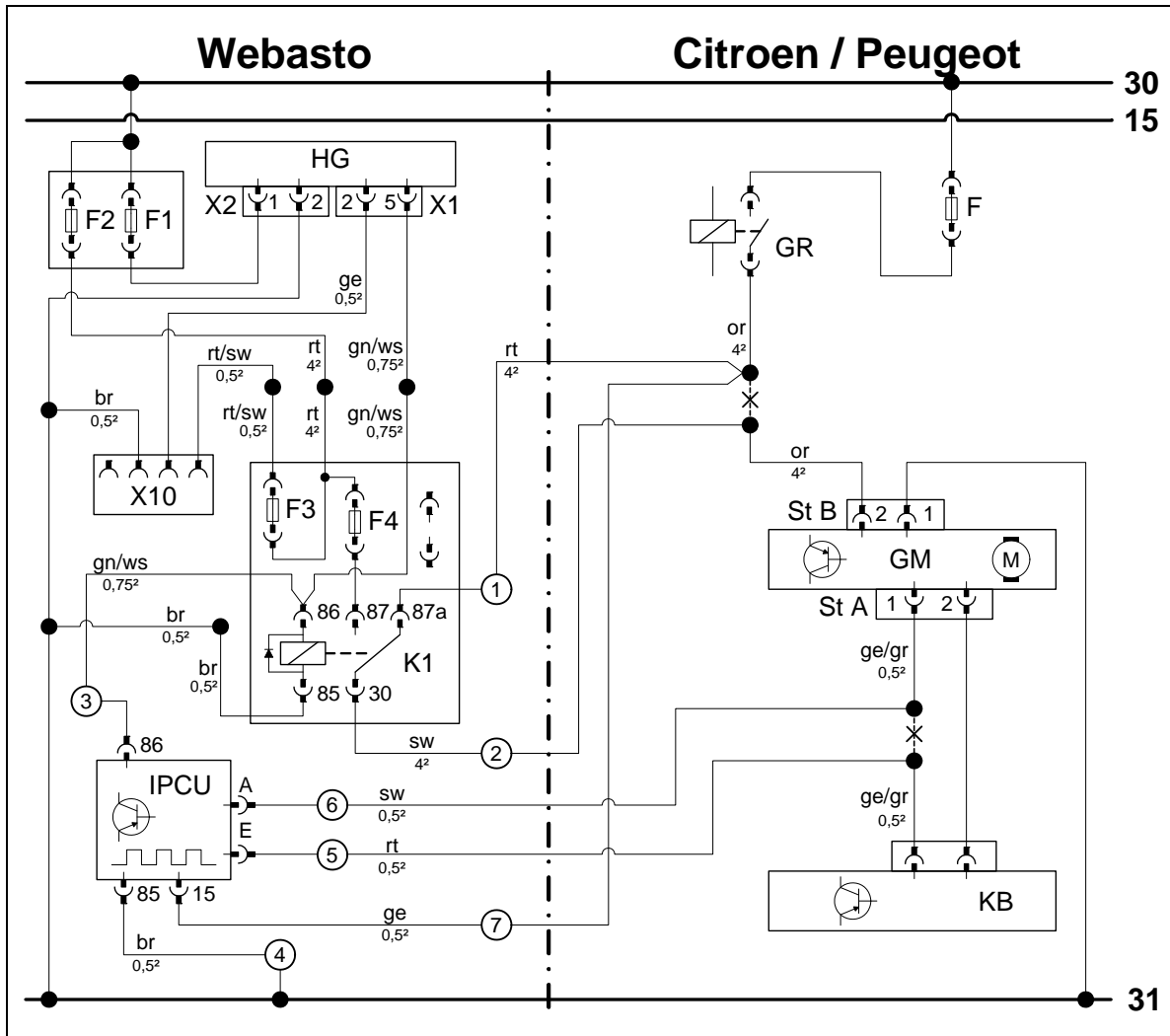

Wiring diagram

Webasto components		Vehicle components		Colours and symbols	
HG	TT-Evo heater	F	Fuse	rt	red
X1	6-pin heater connector	GR	Fan relay	sw	black
X2	2-pin heater connector	St B	2-pin connector GM	ge	yellow
X10	4-pin connector of heater control	GM	Fan module	gn	green
K1	Fan relay	St A	2-pin connector GM	or	orange
F1	20A fuse	KB	A/C control unit	ws	white
F2	30A fuse			br	brown
F3	1A fuse			gr	grey
F4	25A fuse				
IPCU	Pulse width modulator				
IPCU settings:					
Duty cycle: 33%					
Frequency: 1000Hz					
Voltage: 5V				X	Cutting point
Function: High side				Wiring colours may vary.	

Legend

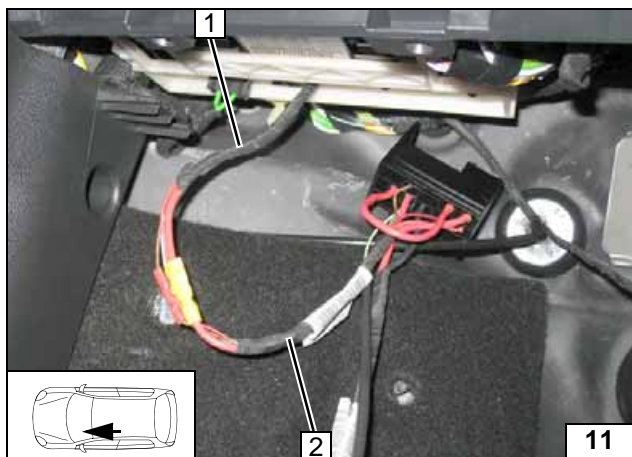

Connect wiring harness of passenger compartment relay and fuse holder 2 to wiring harness of heater 1 according to wiring diagram, in such a way that the wires of the same colour are connected to each other.



**Connect-
ing wiring
harnesses**

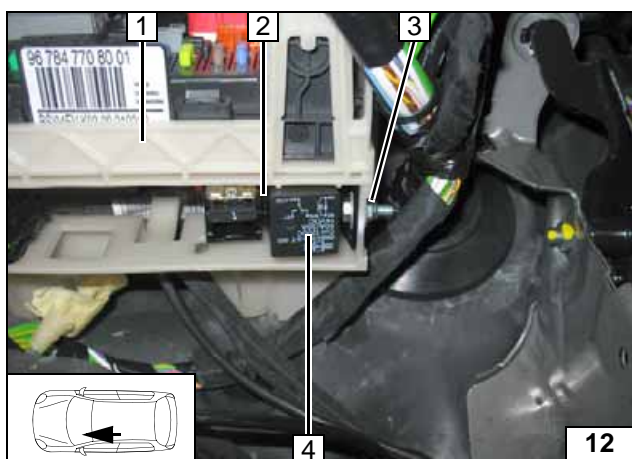

Tie back original vehicle relay with cable ties, if present.



- 1 Fuse and relay box of passenger compartment
- 2 Relay and fuse holder of passenger compartment
- 3 M5x16 bolt, large diameter washer [2x], nut
- 4 K1 relay mounted

**Mounting
passenger
compartment
relay and fuse
holder**

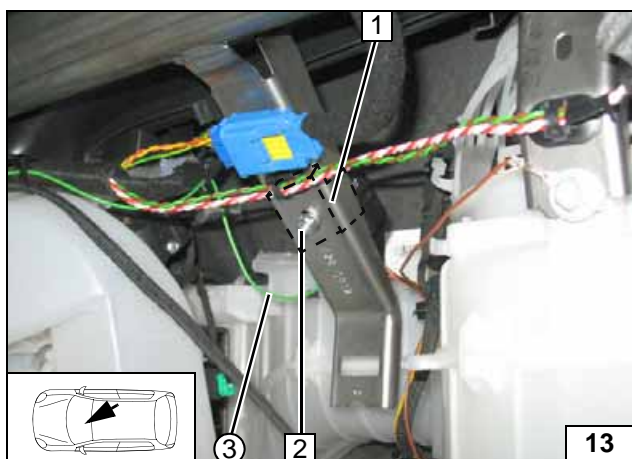

Before installation, insert green/white (gn/ws) wire ③ from K1/86 in socket IPCU/86.



- 1 Socket of IPCU covered (installed behind original vehicle strut)
- 2 M5x16 bolt, large diameter washer, flanged nut

**Installing
IPCU sock-
et**

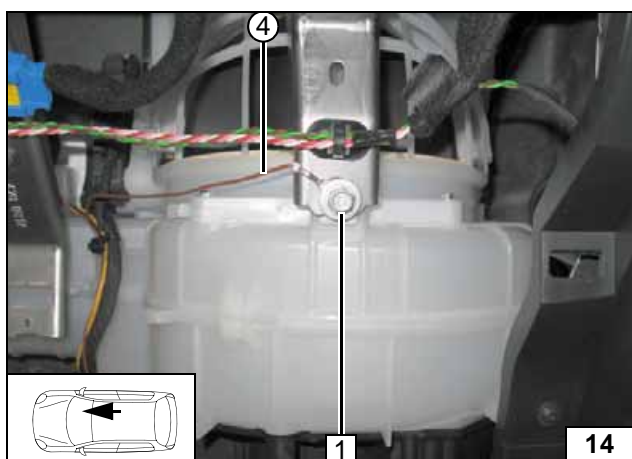

- 1 Original vehicle bolt
- ④ Brown (br) wire of IPCU/85, cable lug

**Earth con-
nection of
IPCU**

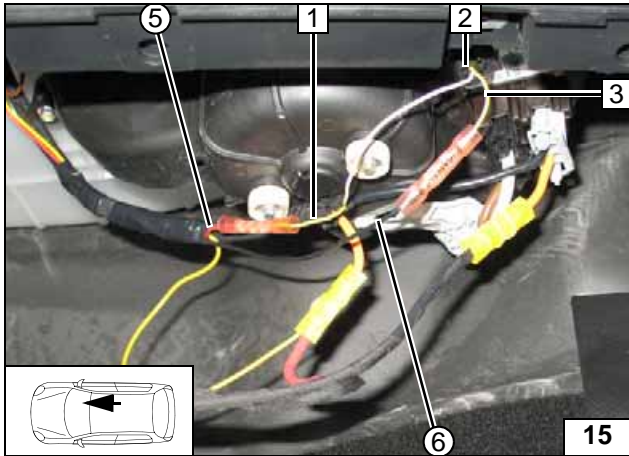

Fan controller is controlled on 2-pin connector A 2 of fan module.
Produce connections as shown in wiring diagram.

- 1 Yellow/grey (ge/gr) wire of A/C control panel
- 3 Yellow/grey (ge/gr) wire of connector A, Pin 1
- ⑤ Red (rt) wire from IPCU/E
- ⑥ Black (sw) wire from IPCU/A

**Connect-
ing fan con-
troller**

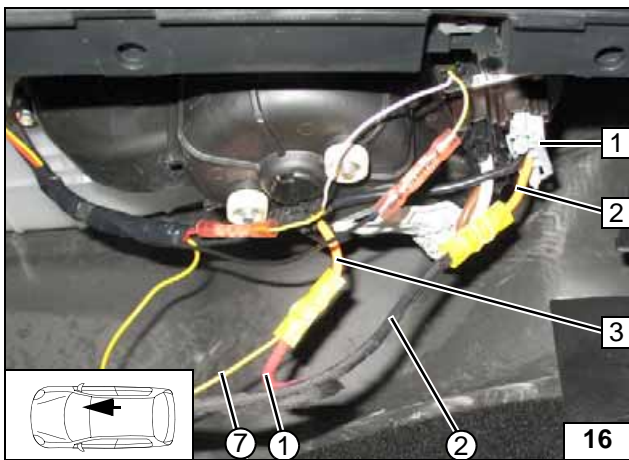

Fan motor is controlled on 2-pin connector B 1 of fan module.
Produce connections as shown in wiring diagram.

- 2 Orange (or) wire of connector B, pin 2
- 3 Orange (or) wire of GR
- ① Red (rt) wire of K1/87a
- ② Black (sw) wire from K1/30
- ⑦ Yellow (ge) wire of IPCU/15

**Connect-
ing fan mo-
tor**



Digital Timer

- 1 Digital timer



Installing digital timer



Remote Option (Telestart)

Fasten receiver 1 with double-sided adhesive tape.



Installing receiver

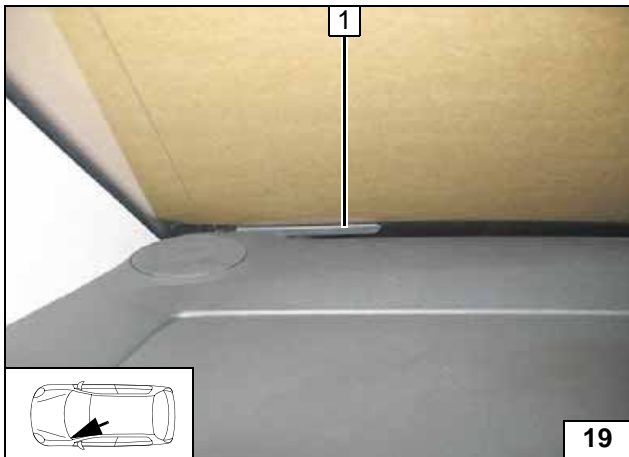

- 1 Antenna

Installing antenna

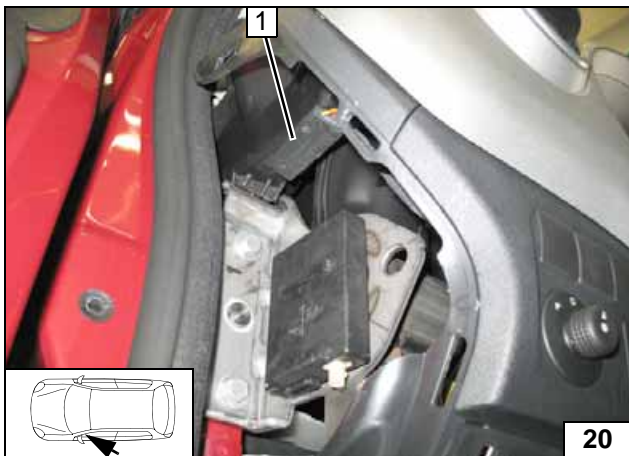

Temperature sensor for HTM100 only

- 1 Fasten temperature sensor with adhesive tape



Installing temperature sensor



Remote Option (Thermocall TC3)

Fasten receiver 1 with double-sided adhesive tape.

Installing receiver

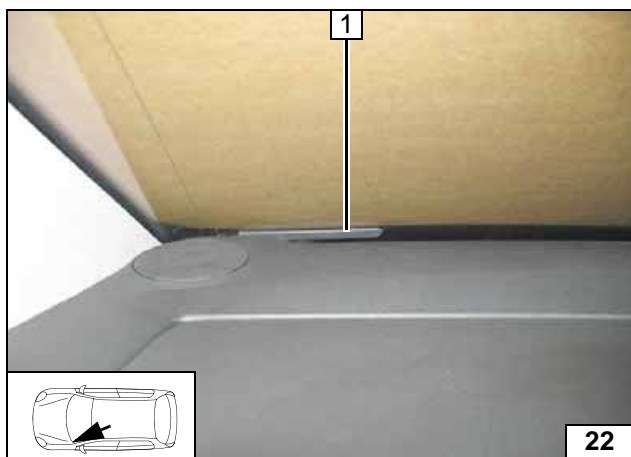

1 Antenna

Installing antenna

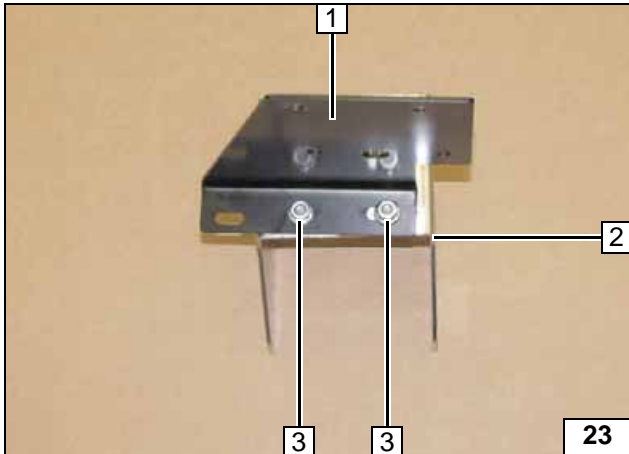

Preparing Installation Location

Insert one 5 mm shim each between retaining plate 1 and bracket 2 at position 3.

- 3 M6x16 bolt, 5mm shim, flanged nut [2x each]



Premounting bracket

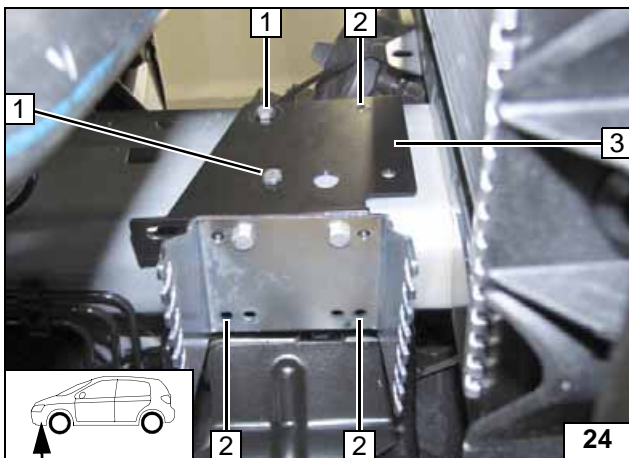

- 1 M6x20 bolt, existing threaded hole [2x]
- 2 Copy hole pattern [3x]
- 3 Install retaining plate loosely

Copying hole pattern

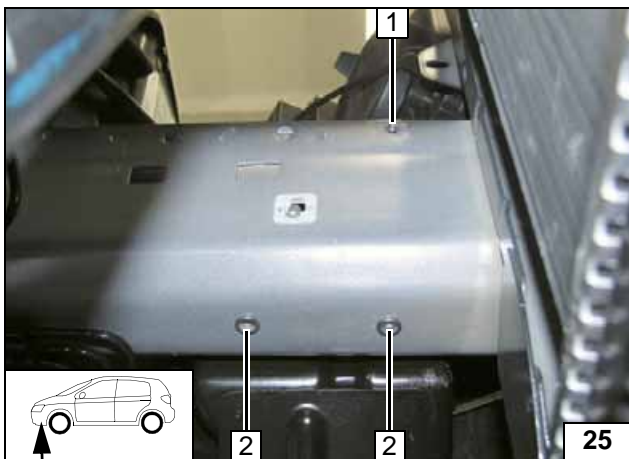

Remove retaining plate with bracket.

- 1 7 mm dia. hole
- 2 9.1mm dia. hole; rivet nut [2x each]

Installing rivet nuts

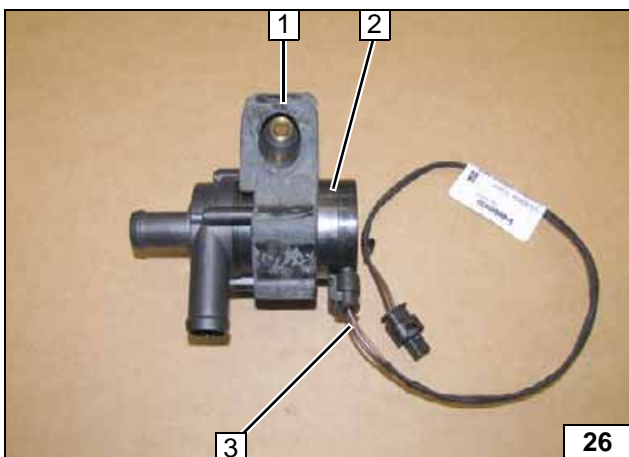

- 1 Circulating pump mounting
- 2 Circulating pump
- 3 Wiring harness of circulating pump

Premounting circulating pump

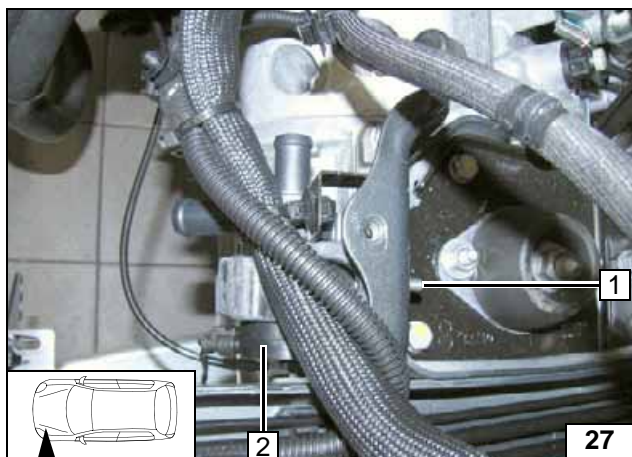

Remove original vehicle bolt at position 1 and discard.

- 1 M6x25 bolt, existing threaded hole
- 2 Circulating pump



Mounting circulating pump

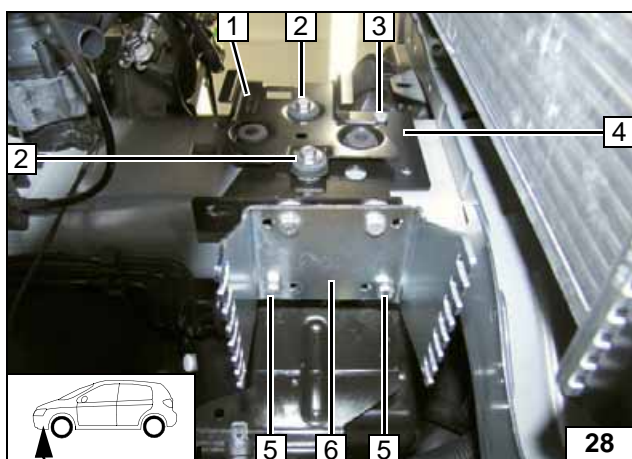

Insert one 20 mm shim each between bracket 6 and frame side member at position 5 [2x].

- 1 Bracket of air filter
- 2 Original vehicle bolt [2x] bracket of air filter
- 3 M6x16 bolt, flanged nut
- 4 Retaining plate
- 5 M6x40 bolt, spring lockwasher, 20mm shim [2x]



Installing bracket

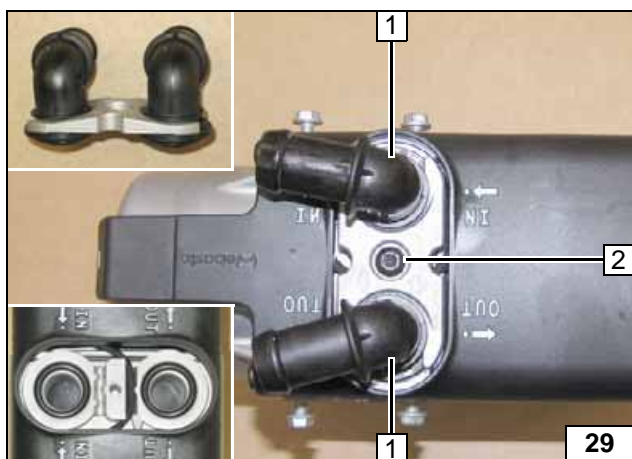

Preparing Heater

- 1 Water connection piece, sealing ring [2x each]
- 2 5x15 self-tapping bolt, retaining plate of water connection pieces



Installing water connection pieces

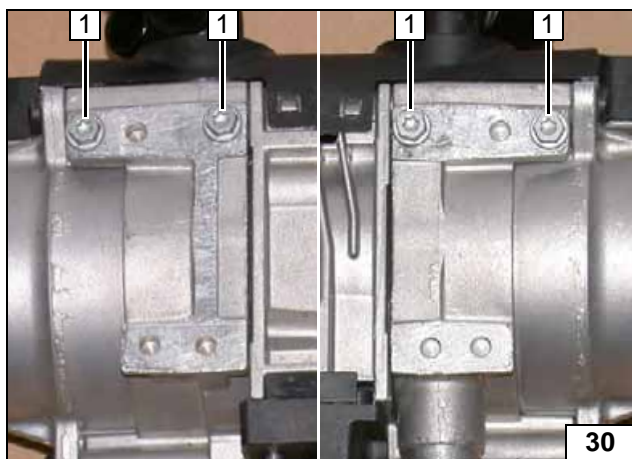

Screw 5x13 self-tapping bolts 1 [4x] into existing holes by a maximum of 3 thread turns.



Premounting bolts loosely

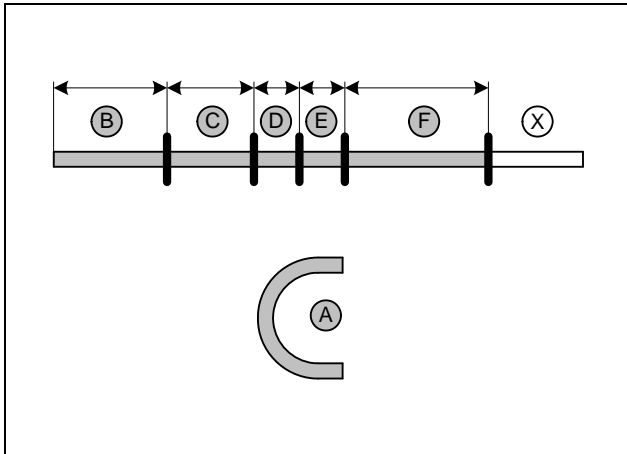

Discard section **X**.

Hose **A** = 18mm dia., 180° moulded hose

- B** = 350
- C** = 170
- D** = 60
- E** = 60
- F** = 670



Cutting hoses to length

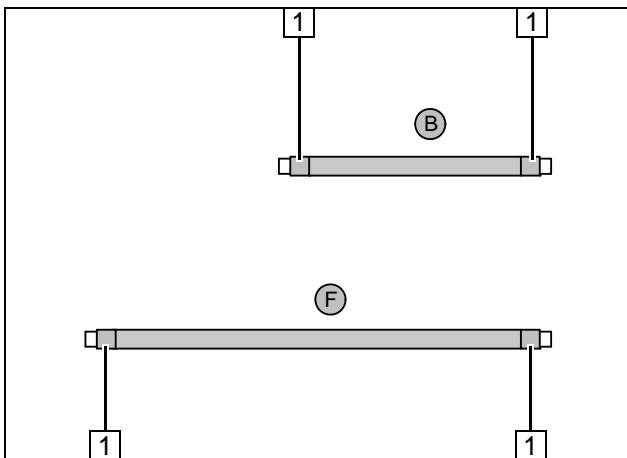

Push braided protection hoses onto hose **B** and **F** and cut to length.
Cut heat shrink plastic tubing to size.



- 1** 50 mm long heat shrink plastic tubing [4x]

Preparing hoses

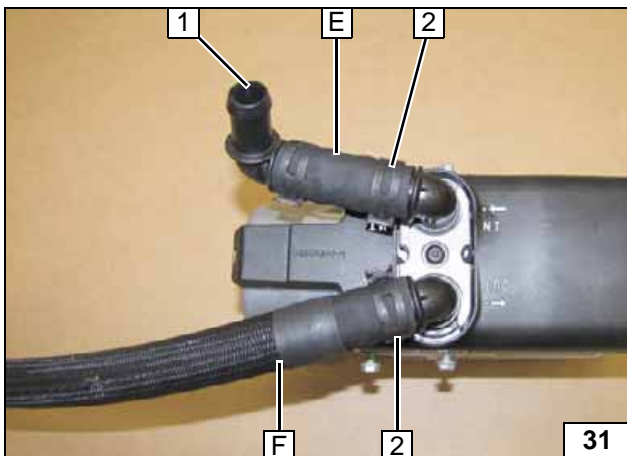

- 1** 90°, 18x18mm connecting pipe, 25mm dia. spring clip
- 2** 25mm dia. spring clip [2x]

Premounting hose

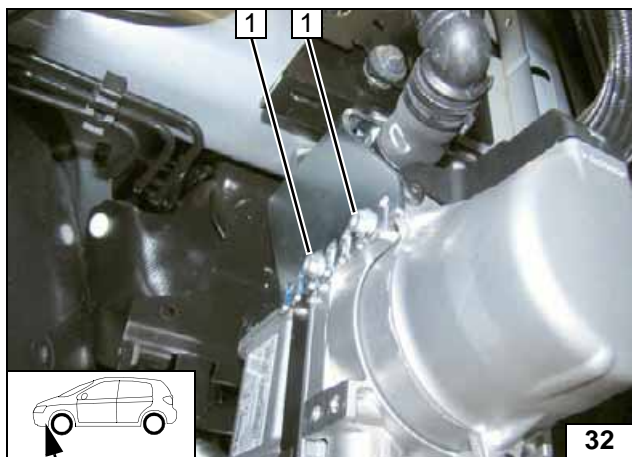

Installing Heater

- 1 Tighten 5x13 self-tapping bolt [2x]

Installing heater

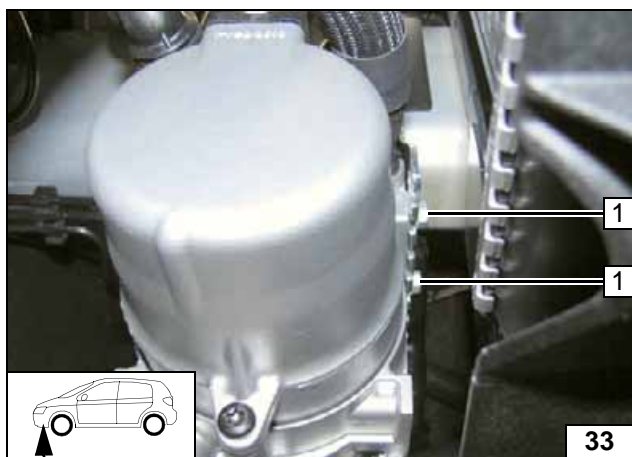

- 1 Tighten 5x13 self-tapping bolt [2x]

Installing heater

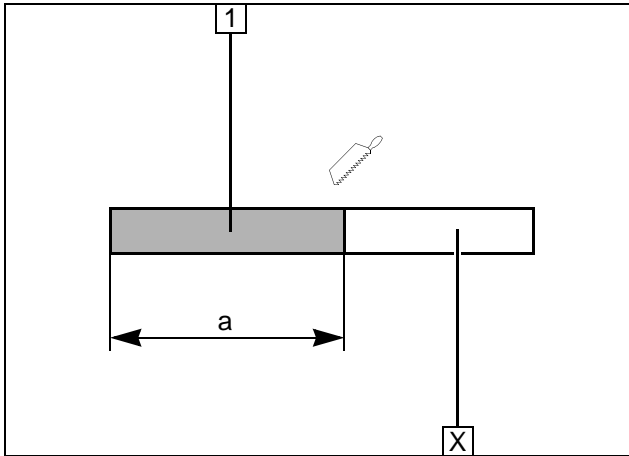
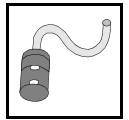

Combustion Air

Discard section X.

- 1 Combustion air pipe
a = 260

Cutting combustion air pipe to length

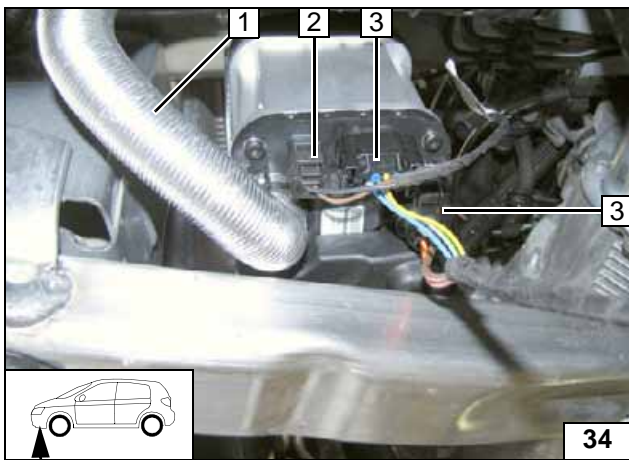

- 1 Combustion air pipe
- 2 Wiring harness of circulating pump
- 3 Wiring harness of heater [2x]

Installing combustion air pipe/wiring harnesses

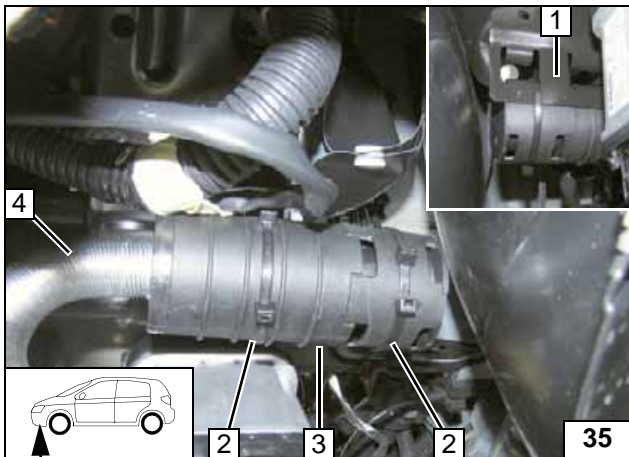

- 1 ABS bracket
- 2 Cable tie [2x each]
- 3 Silencer
- 4 Combustion air pipe



Installing combustion air pipe / silencer





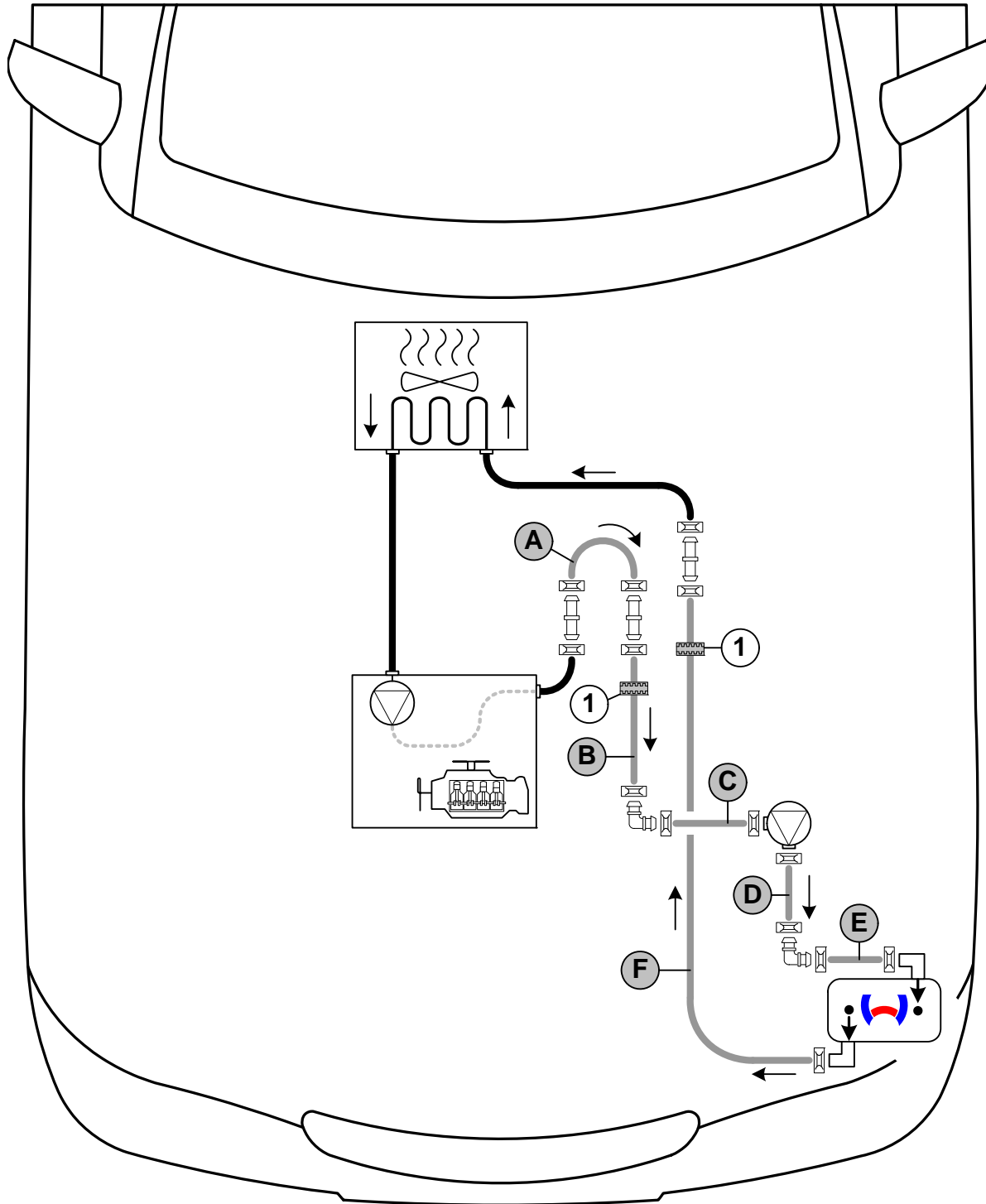

Coolant Circuit

WARNING!

Any coolant running off should be collected in an appropriate container. Route hoses so that they are kink-free. Unless specified otherwise, always fasten using cable ties. Position clamps so that other hoses cannot be damaged. When installing the hoses, the heater must be filled with coolant. The connection should be "inline" based on the following diagram:



Hose routing diagram

All spring clips  = 25 mm dia.
 1 = Black (sw) rubber isolator  [2x].
 All connecting pipes  and  = 18x18 mm dia.



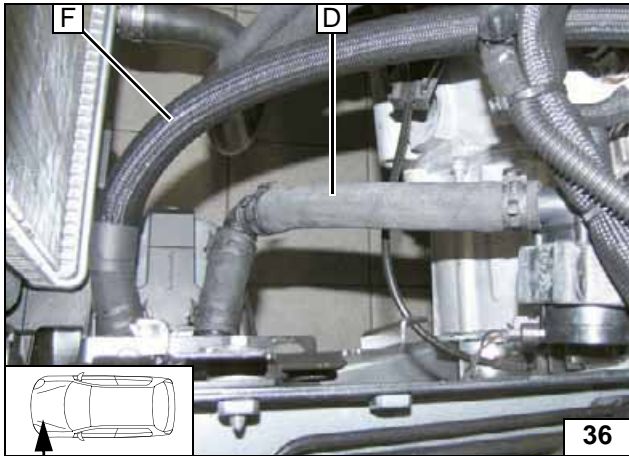

Connect-
ing circu-
lating
pump

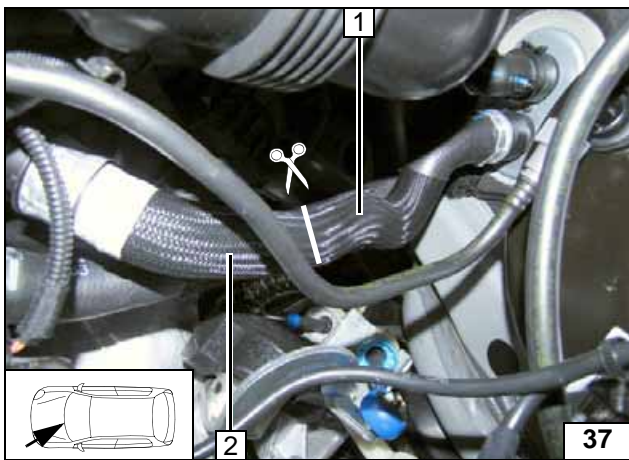

Cut off hose on engine outlet/heat exchanger inlet at marking. Remove braided protective hose from both hose sections.



- 1 Hose section of heat exchanger inlet
- 2 Hose section of engine outlet

Cutting
point

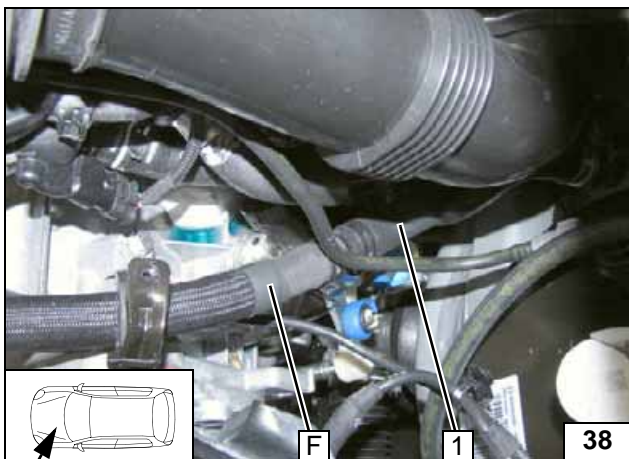

- 1 Hose of heat exchanger inlet

Connect-
ing heat ex-
changer
inlet

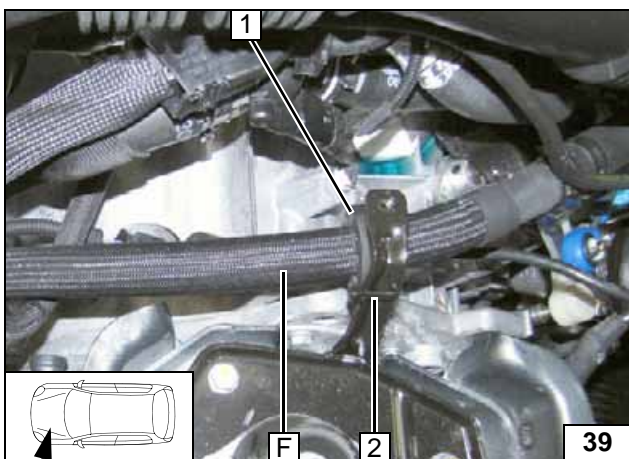

- 1 Slide on black (sw) rubber isolator and align
- 2 Cable tie

Routing in
engine com-
part-
ment

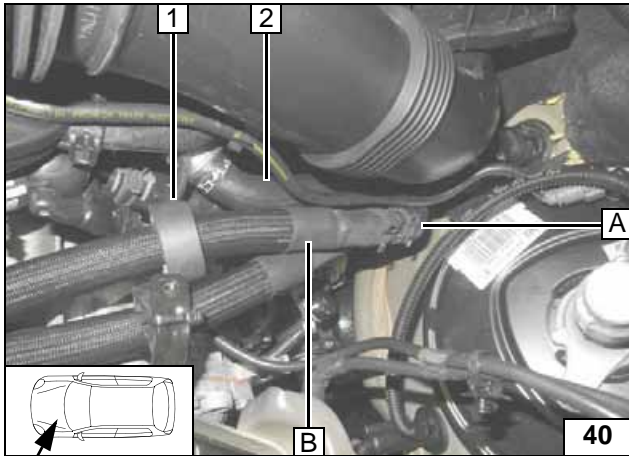

- 1 Slide on black (sw) rubber isolator
- 2 Hose of engine outlet

Connect-
ing engine
outlet

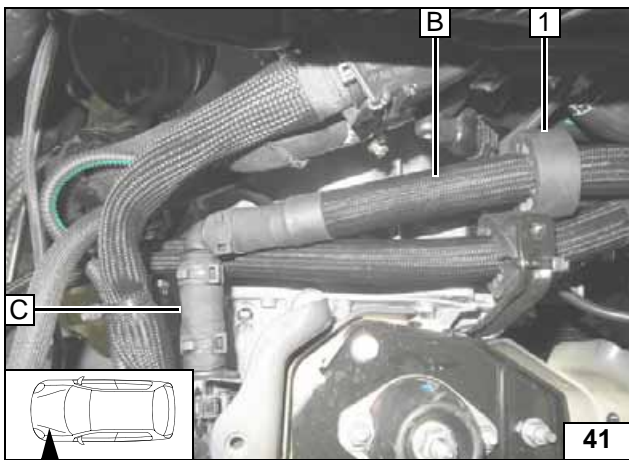

- 1 Position black (sw) rubber isolator

Connect-
ing circu-
lating
pump

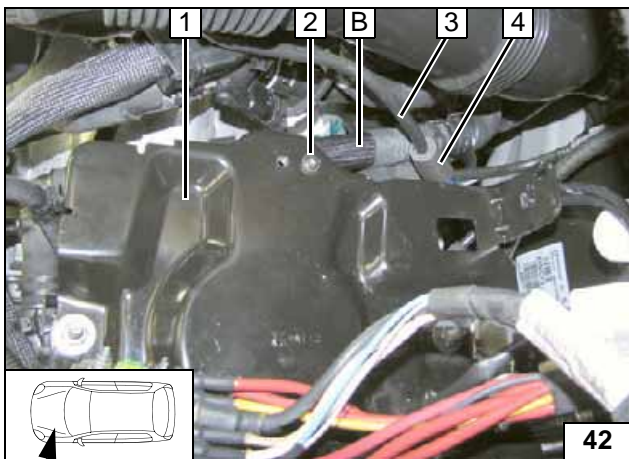

Shorten original vehicle bolt **2** by 5mm.
Wind vacuum line **3** with rub protection **4**.
Align hoses. Ensure sufficient distance from
neighbouring components.

- 1 Battery carrier



Installing
battery car-
rier



Fuel

CAUTION!

Open the vehicle's fuel tank cap, ventilate the tank and then re-close the tank lock.

Catch any fuel running off in an appropriate container.

Install fuel line and metering pump wiring harness so that they are protected against stone impact. Unless specified otherwise, always fasten using cable ties.

Mount the fuel line and wiring harness with rub protection on sharp edges.

WARNING!

The fuel line and wiring harness are routed to the metering pump as shown in the wiring harness routing diagram.

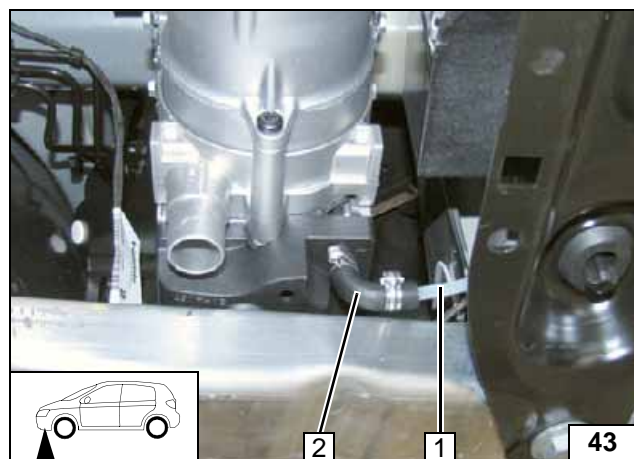

- 1 Fuel line
- 2 90° moulded hose, 10mm dia. clamp [2x]

**Connect-
ing Heater**

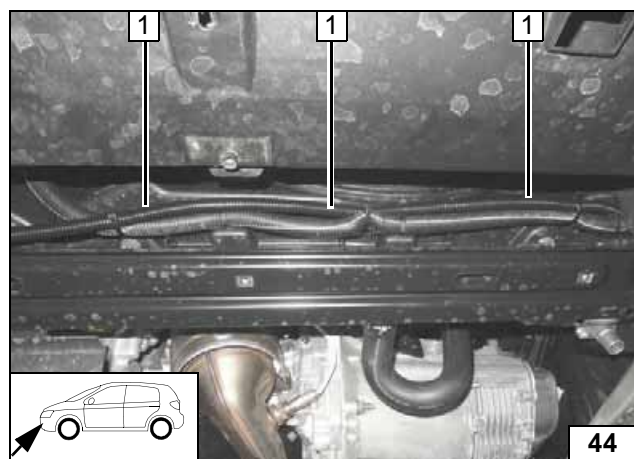

Route fuel line and wiring harness of metering pump into 2100mm corrugated tube 1 to the right vehicle side.



**Routing
lines**

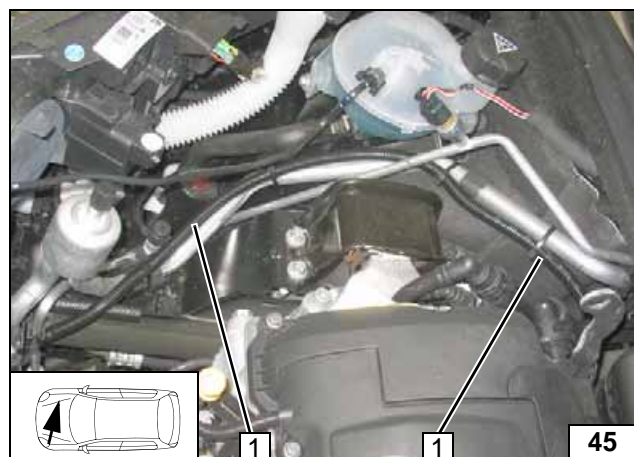

Route fuel line and wiring harness of metering pump into corrugated tube 1 along the A/C line to the firewall.



**Routing
lines**

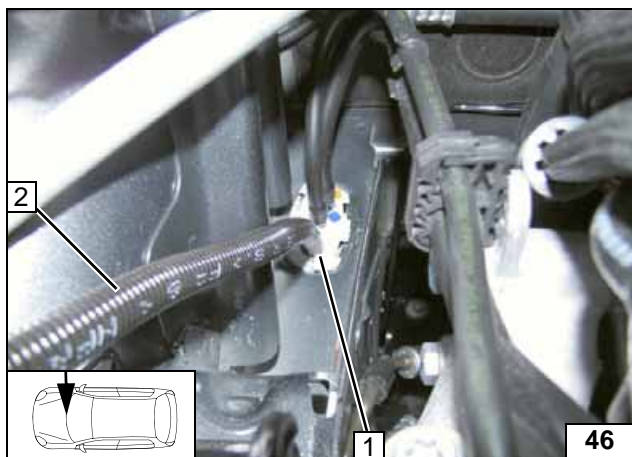

Route fuel line and wiring harness of metering pump in original vehicle line duct to the underbody.



- 1 Original vehicle pass through
- 2 Fuel line and wiring harness of metering pump in corrugated tube

Routing lines

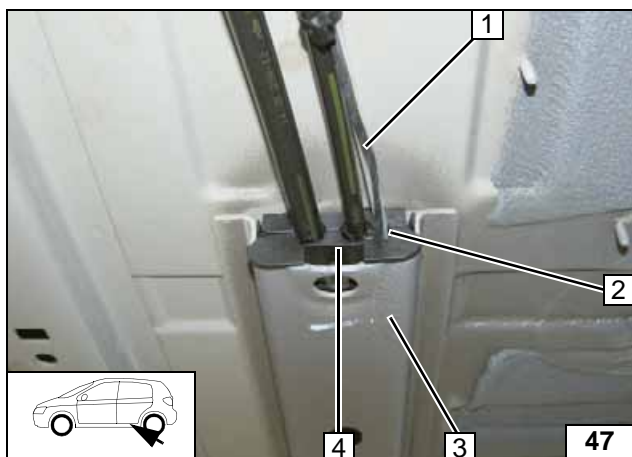

8mm dia. hole at position 2 in original vehicle sealing 4!



- 1 Fuel line, wiring harness of metering pump
- 3 Original vehicle line duct

Routing lines

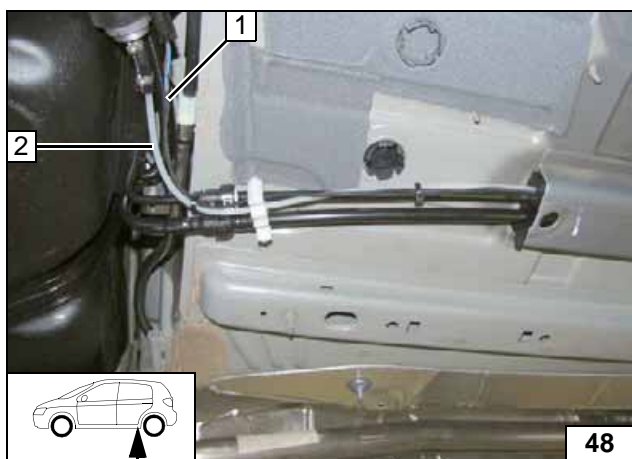

- 1 Wiring harness of metering pump
- 2 Fuel line

Routing lines

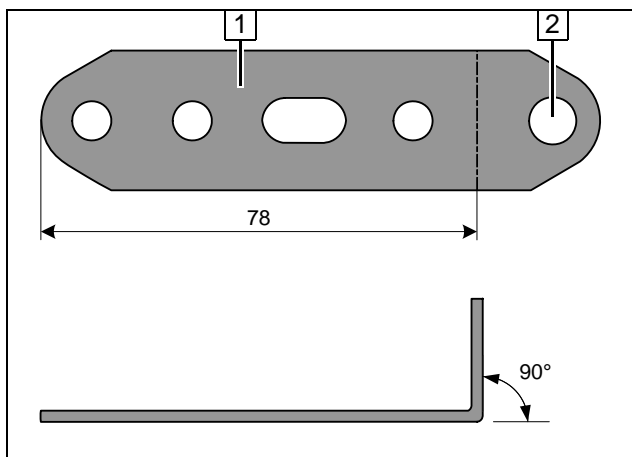

- 1 Perforated bracket
- 2 Drill out 9 mm dia. hole

Preparing perforated bracket

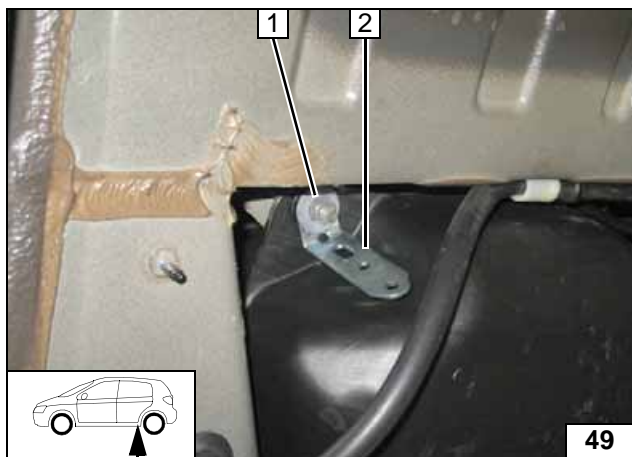

- 1 Perforated bracket
- 2 Original vehicle bolt

Mounting
metering
pump

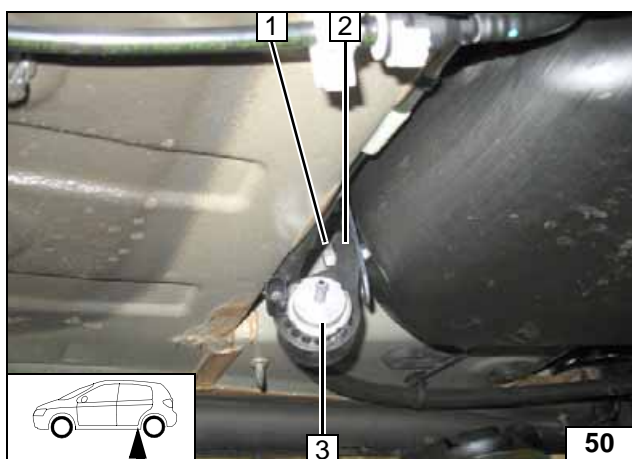

- 1 M6x25 bolt, flanged nut
- 2 Mounting of metering pump
- 3 Metering pump

Mounting
metering
pump

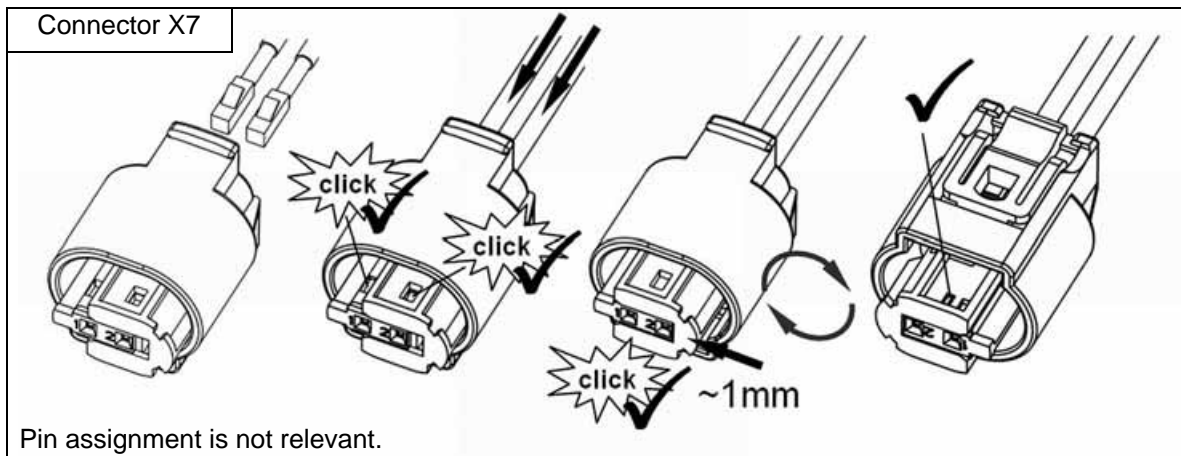

Completing
connector of
metering
pump

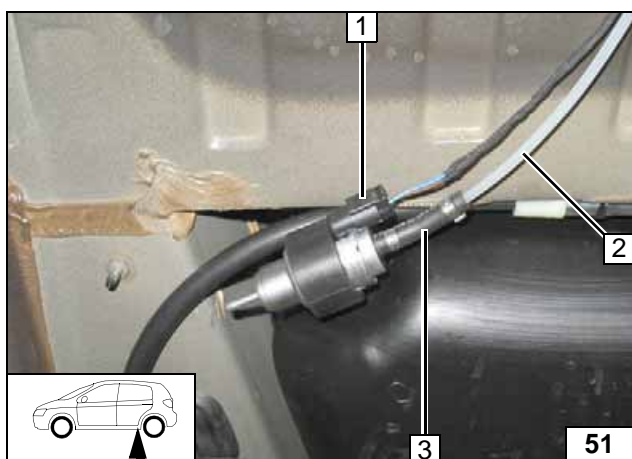

- 1 Wiring harness of metering pump, connector mounted
- 2 Fuel line of heater
- 3 Hose section, 10mm dia.clamp [2x]

Connecting
metering
pump

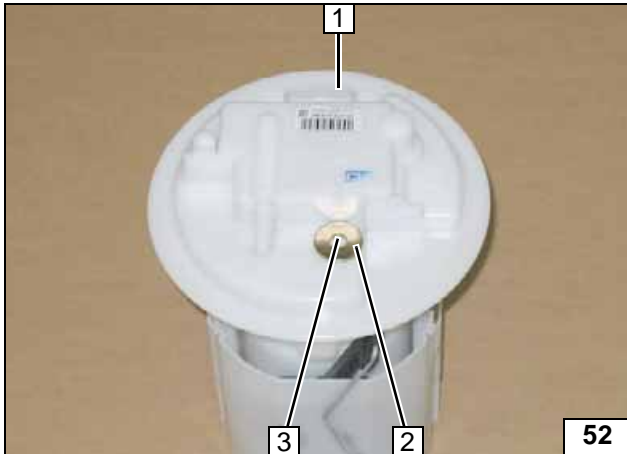

In accordance with manufacturer's instructions:
Detach fuel tank and lower back.
Remove fuel-tank sending unit 1.

- 2 Washer with outer dia. $d_a = 21.6\text{mm}$
- 3 Copy hole pattern, 6mm dia. hole



Fuel extraction

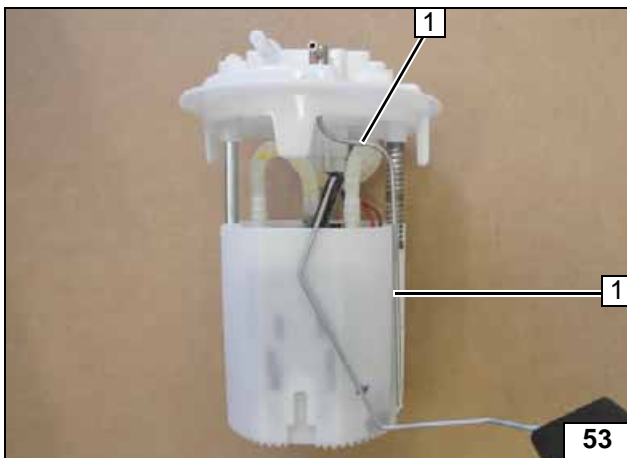

Shape fuel standpipe 1 as shown in the template and cut it to length.



Mounting fuel stand-pipe

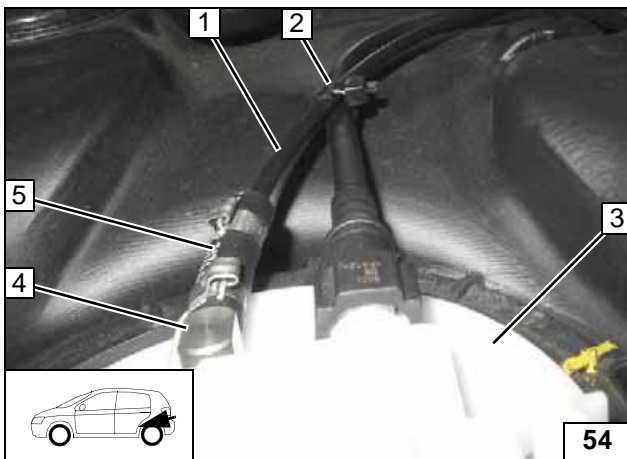

Install fuel-tank sending unit 3 in accordance with the manufacturer's instructions.
Route fuel line 1 to metering pump along original vehicle fuel line and fasten.
Install fuel tank.

- 2 Cable tie
- 4 Fuel standpipe
- 5 Hose section, 10mm dia.clamp [2x]



Connect-ing fuel line

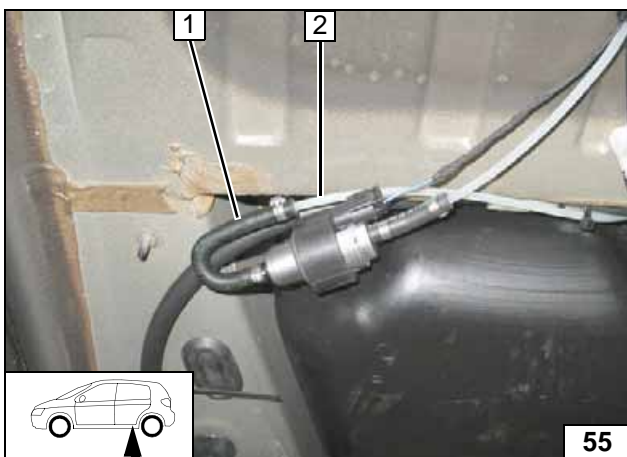

Check the position of the components; adjust if necessary. Check that they have freedom of movement.

- 1 180° moulded hose, 10mm dia. clamp [2x]
- 2 Fuel line



Connect-ing meter-ing pump

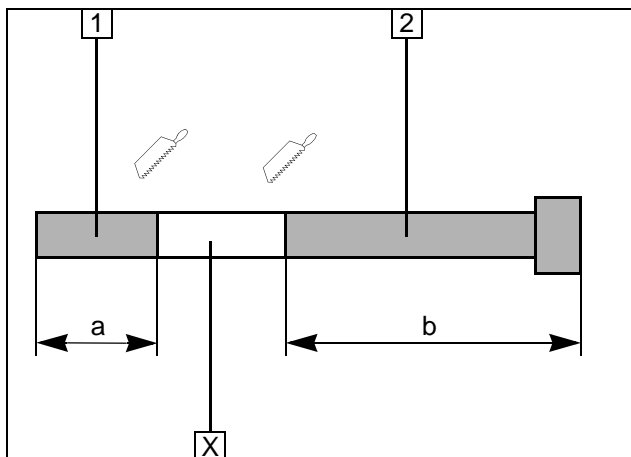
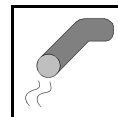

Exhaust Gas

Discard section X.

- 1 Exhaust pipe
a = 70
- 2 Exhaust end section
b = 220

Preparing exhaust pipe

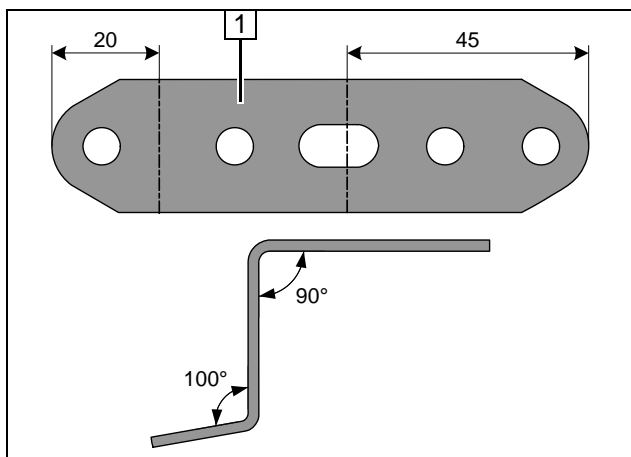

- 1 Perforated bracket

Angling down perforated bracket

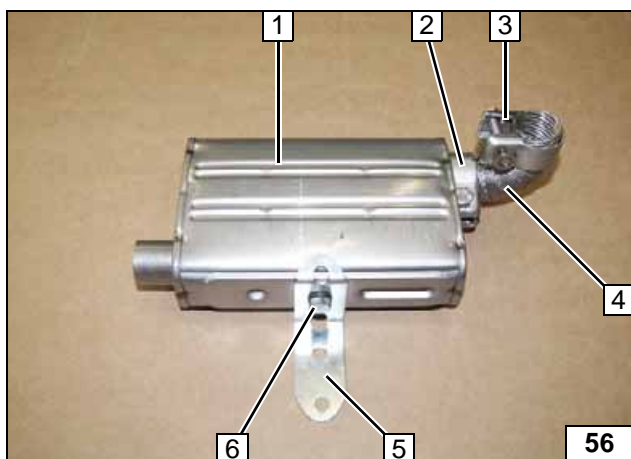

- 1 Silencer
- 2 Hose clamp
- 3 Premount hose clamp
- 4 Exhaust pipe
- 5 Perforated bracket
- 6 M6x16 bolt, spring lockwasher

Premounting silencer

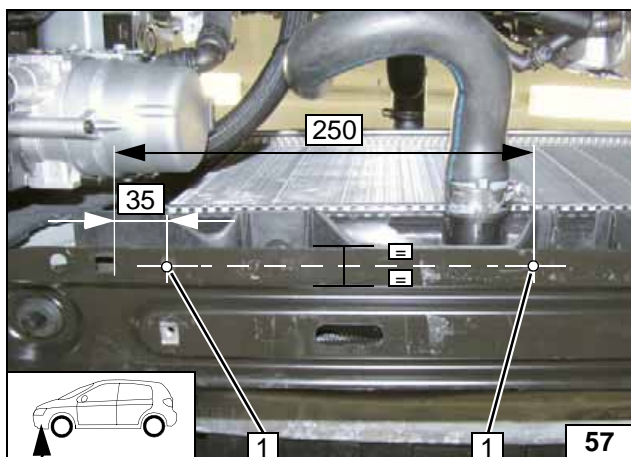

- 1 7mm dia. hole [2x]

Holes in cross member

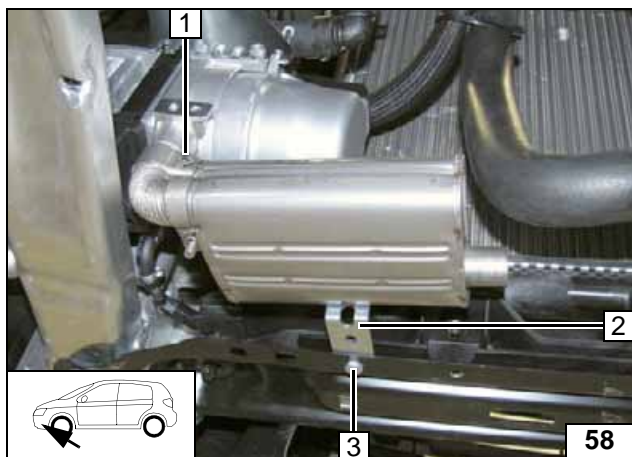
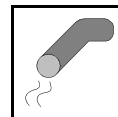

- 1 Tighten hose clamp
- 2 Perforated bracket
- 3 M6x12 bolt, flanged nut

**Mounting
silencer**

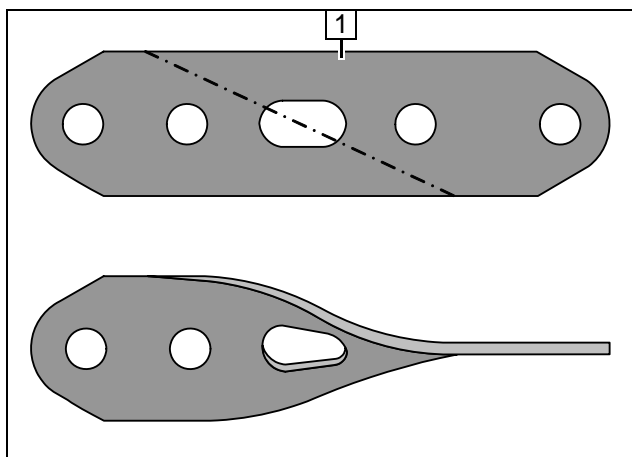

- 1 Twist 90° perforated bracket in longitudinal axis

**Preparing
perforated
bracket**

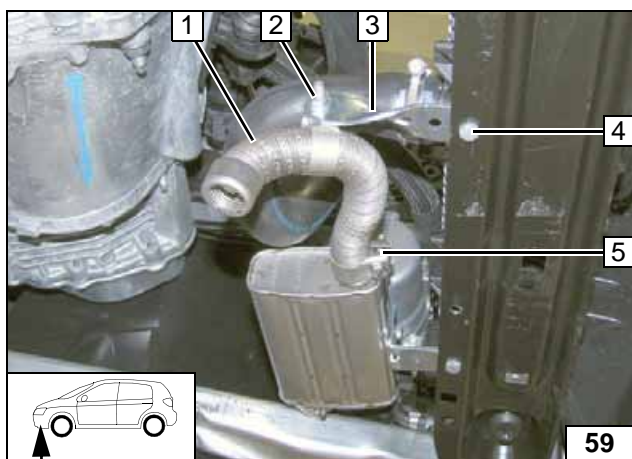

- 1 Exhaust end section
- 2 M6x20 bolt, p-clamp, flanged nut
- 3 Perforated bracket
- 4 M6x12 bolt, flanged nut
- 5 Hose clamp

**Installing
exhaust
end section**

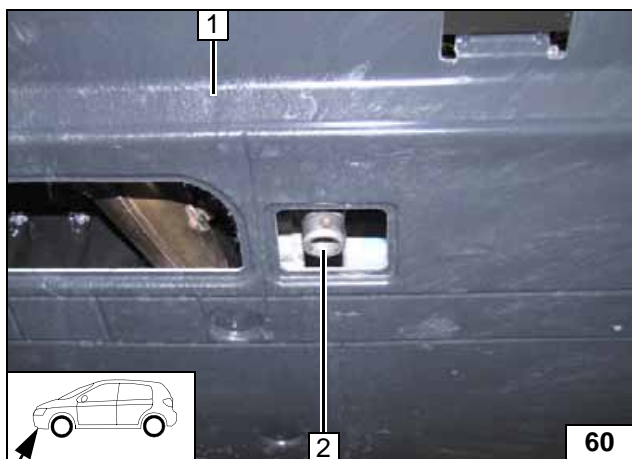

Install underride protection 1 (if existing). Ensure sufficient distance from silencer; correct if necessary. Align exhaust end section 2 centrally in the recess of underride protection 1.



**Aligning
exhaust
end section**



Final Work

WARNING!

Mount removed parts in reverse order. Check all hoses, clamps and all electrical connections for firm seating. Insulate all loose wires and tie back.

Only use manufacturer-approved coolant. Spray the heater components with anti-corrosion wax (Tectyl 100K, Order No. 111329).



- **Connect the battery.**
- **Fill and bleed the coolant circuit according to the vehicle manufacturer's specifications.**
- **Adjust digital timer, teach telestart transmitter.**
- **Make settings on A/C control panel according to the "Operating Instructions for End Customer".**
- **Place the "Switch off parking heater before refuelling" caution label in the area of the filler neck.**
- **For initial startup and function check, please see installation instructions.**



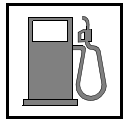

Template for Fuel Standpipe

Top view

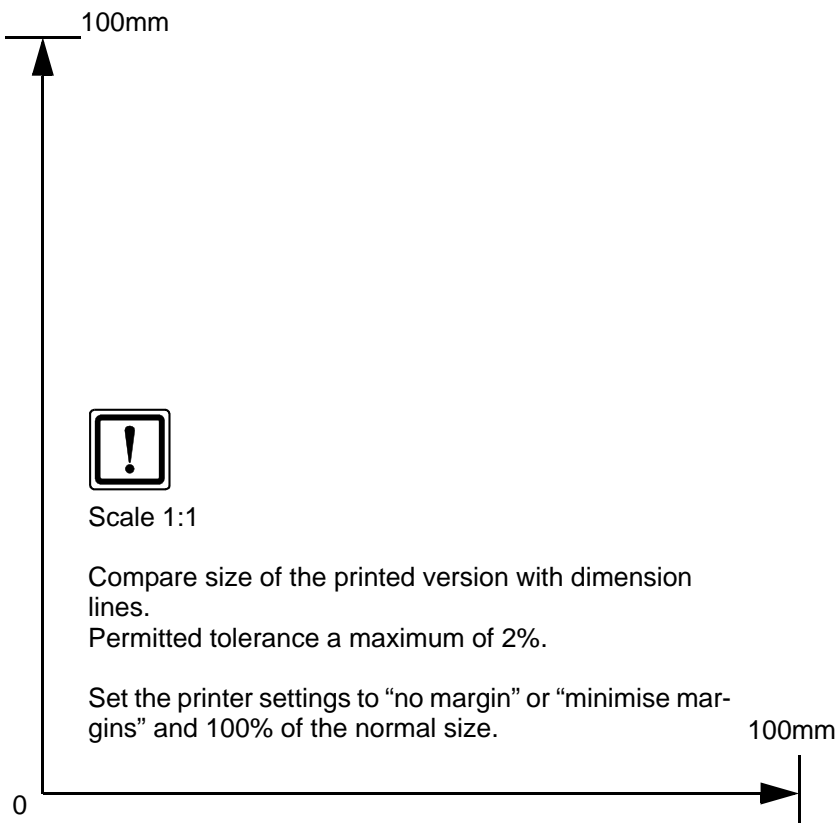
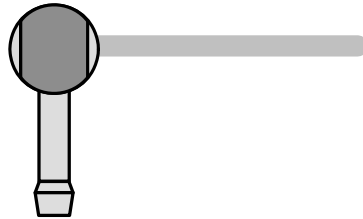

Operating Instructions for End Customer

Please remove page and add to the vehicle operating instructions.

Note:

We recommend matching the heating time to the driving time.

Heating time = driving time

Example:

For a driving time of approx. 20 min. (in one direction), we recommend not exceeding a switch-on time of 20 min.

Passenger compartment monitoring, if installed, must be deactivated in addition to the vehicle settings for the heating operation.

For instructions on deactivation, please refer to the operating instructions of the vehicle.

Before parking the vehicle, make the following settings:

No specific settings necessary.



61



A/C control panel

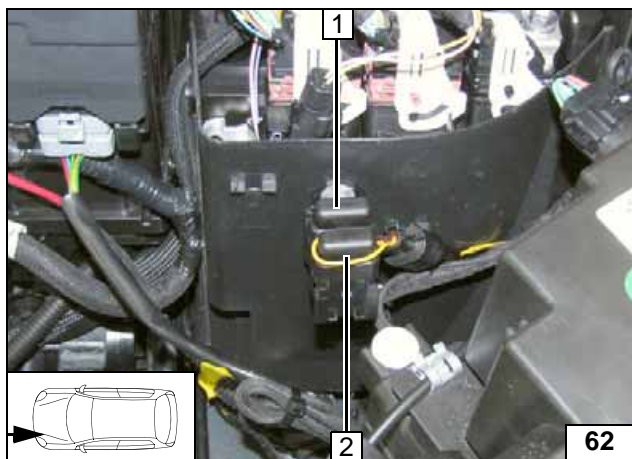

62

- 1 30A passenger compartment main fuse F2
- 2 20A heater fuse F1

Fuses of engine compartment

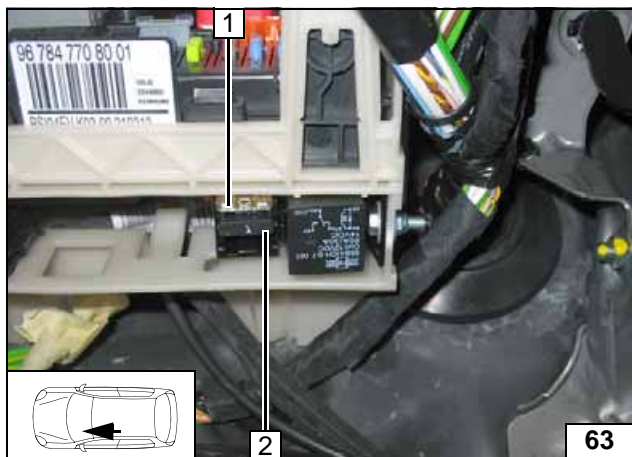

63

- 1 25A fan fuse F4
- 2 1A fuse of heater control F3

Fuses of passenger compartment

