

K Installation Documentation

for Thermo Top Evo water heater

Audi Q5

Left-hand drive vehicle

| Manufacturer | Model | Type | Model year | EG-BE-No. / ABE | | |
|--------------|--------|-------------------|-------------------|-----------------------|--------------------------------|-------------|
| Audi | Q5 | FY | from 2017 | e1* 2007/46* 1550*... | | |
| Motorisation | Fuel | Emission standard | Transmission type | Output[kW] | Displacement[cm ³] | Engine code |
| 2.0D | Diesel | Euro 6 | SG | 110 | 1968 | DEUA |
| 2.0D | Diesel | Euro 6 | AG | 120 | 1968 | DETB |
| 2.0D | Diesel | Euro 6 | AG | 140 | 1999 | DETA |
| 3.0D | Diesel | Euro 6 | AG | 210 | 2967 | DCPC |

| Validity | Equipment variants | Model |
|-------------------------------|-----------------------------------|-------|
| | | Q5 |
| Verified equipment variants | 1 zone automatic air-conditioning | x |
| | 3 zone automatic air-conditioning | x |
| | LED main headlights | x |
| | LED daytime running lights | x |
| | Xenon headlights | x |
| | Automatic Start-Stop system | x |
| | Start button | x |
| | Headlight washer system | x |
| Unverified equipment variants | 24L Ad Blue tank | x |
| | Halogen main headlights | x |
| | Dynamic cornering light | x |
| | Front fog lights | x |
| | Alarm system | x |

| Total installation time | Note |
|-------------------------|------|
| 10.0 hours | |

Contents

| | | | | | |
|-----------|--|-----------|-----------|---|-----------|
| 1 | List of abbreviations | 3 | 14 | Electrical system of passenger compartment | 45 |
| 2 | Installation notes | 4 | 14.1 | Installation instructions for passenger compartment | 45 |
| 2.1 | Information on Validity | 4 | 14.2 | Electrical System Preparation | 48 |
| 2.2 | Components used | 4 | 14.3 | Wiring diagram | 50 |
| 2.3 | Information on Total Installation Time | 4 | 14.4 | Fan controller | 52 |
| 2.4 | Installation recommendations | 4 | 15 | Electrical system of control element | 54 |
| 3 | About this document | 5 | 15.1 | MultiControl CAR option | 54 |
| 3.1 | Purpose of the document | 5 | 15.2 | Telestart option | 54 |
| 3.2 | Warranty and liability | 5 | 15.3 | ThermoCall option | 55 |
| 3.3 | Safety | 5 | 16 | Final Work | 56 |
| 3.4 | Using this document | 6 | 17 | Operating instructions for 1-zone automatic air-conditioning | 59 |
| 4 | Technical Information | 7 | 17.1 | A/C control panel settings | 59 |
| 5 | Preparing measures | 8 | 17.2 | Installation location of fuses | 59 |
| 5.1 | Vehicle preparation | 8 | 18 | Operating instructions for 3-zone automatic air-conditioning | 61 |
| 5.2 | Heater preparation | 8 | 18.1 | A/C control panel settings | 61 |
| 6 | Installation overview | 9 | 18.2 | Installation location of fuses | 61 |
| 7 | Electrical system of engine compartment | 10 | | | |
| 8 | Mechanical system | 13 | | | |
| 8.1 | Installation location preparation | 13 | | | |
| 8.2 | Premounting heater | 14 | | | |
| 8.3 | Heater installation | 16 | | | |
| 9 | Fuel | 18 | | | |
| 10 | Combustion air | 25 | | | |
| 11 | Coolant for 2.0 D vehicles | 26 | | | |
| 11.1 | Hose routing diagram | 26 | | | |
| 11.2 | Coolant circuit installation | 27 | | | |
| 12 | Coolant for 3.0 D vehicles | 35 | | | |
| 12.1 | Hose routing diagram | 35 | | | |
| 12.2 | Coolant circuit installation | 36 | | | |
| 12.2.1 | Connection in coolant reservoir | 36 | | | |
| 12.2.2 | Connection in engine compartment | 37 | | | |
| 13 | Exhaust | 41 | | | |

1 List of abbreviations

| | |
|------|--|
| AG | Automatic transmission |
| ASH | Spacer bracket |
| DP | Fuel pump |
| EFIX | Exhaust end fastener |
| Fig. | Figure |
| HG | Heater |
| MCC | MultiControl (control element) |
| RSH | Relay and fuse holder of passenger compartment |
| SG | Manual transmission |
| SH2 | Engine compartment fuse holder for F1/F2 |
| UP | Coolant pump |
| Veh. | Vehicle |

2 Installation notes

2.1 Information on Validity

This installation documentation applies to vehicles listed on page 1, assuming technical modifications to the vehicle do not affect installation, any liability claims excluded. Depending on the vehicle version and equipment, modifications may be necessary during installation with respect to this installation documentation. Vehicle and engine types, equipment variants and other specifications not listed in this installation documentation have not been tested. However, installation according to this installation documentation may be possible.

2.2 Components used

| Designation | Order number |
|--|-------------------------------|
| Basic delivery scope of Thermo Top Evo in accordance with price list | In accordance with price list |
| Installation kit for Audi Q5 2016 Diesel | 1325710B |
| In case of Telestart, control element, as well as indicator lamp in consultation with end customer | In accordance with price list |

2.3 Information on Total Installation Time

The total installation time includes the time needed for mounting and demounting the vehicle-specific components, the heater specific installation time and all other times required for the system integration and initial start-up of the heater.

The total installation time may vary for vehicle equipment other than provided.

2.4 Installation recommendations

Arrange for the vehicle to be delivered with the tank only about $\frac{1}{4}$ full.

For the MultiControl CAR option, the recommended installation locations for the Telestart or ThermoCall push button should be confirmed with the end customer.

Depending on the space required and the vehicle manufacturer's instructions, we recommend the use of a vehicle battery with a higher electrical capacity.

3 About this document

3.1 Purpose of the document

This installation documentation is part of the product and contains information for the correct vehicle specific installation of the:

| |
|-----------------------|
| Thermo Top Evo heater |
|-----------------------|

3.2 Warranty and liability

Webasto shall assume no liability for defects, damage and injuries resulting from a failure to observe the installation, repair and operating instructions of the information contained in them.

This liability exclusion particularly applies to improper installations and repairs by untrained persons or in the case of a failure to use genuine spare parts.

The liability due to culpable disregard to life, limb or health and due to damage or injuries caused by a wilful or reckless breach of duty remain unaffected, as does the obligatory product liability.

Installation should be carried out according to the general, standard rules of technology. Unless specified otherwise, fasten hoses, lines and wiring harnesses to original vehicle lines and wiring harnesses using cable ties. Insulate loose wire ends and tie back. Connectors on electronic components must audibly snap into place during assembly.

Spray unfinished body areas, e.g. drilled holes, with anti-corrosion wax (Tectyl 100K).

Observe the instructions and guidelines of the respective vehicle manufacturer for demounting and mounting vehicle specific components.

The initial start-up is to be executed with the Webasto Thermo Test Diagnosis.

When installing a programmable control module (e.g. a PWM Gateway), the corresponding settings must be checked or adjusted.

3.2.1 Statutory regulations governing installation

The Thermo Top Evo heater has been type-tested and approved in accordance with ECE-R 10 (EMC) and ECE-R 122 (heater). The regulations of these guidelines are binding in the scope of the Directive 70/156/EEC and/or 2007/46/EC (for new vehicle models from 29/04/2009) and should also be observed in countries in which there are no special regulations.

The heater is licensed in accordance with paragraph 19, section 3, No. 2b of the StVZO (German Road Traffic Licensing Authority).

3.3 Safety

Qualifications of installation personnel

The installation personnel must have the following qualifications:

- Successful completion of Webasto training
- Corresponding qualification for working on technical systems

Regulations and legal requirements

The regulations from the heater's general installation and operating instructions must be observed.

3.3.1 Safety information on installation

Danger posed by live parts

- ▶ Prior to installation, disconnect the vehicle from the voltage supply.
- ▶ Make sure the electrical system is earthed correctly.
- ▶ Always comply with legal requirements.
- ▶ Observe data on type label.

Danger of fire and leaking toxic gases due to improper installation

- ▶ Vehicle parts in the vicinity of the heater must be protected against excessive heating by the following measures:
 - ⇒ Maintain minimum safety distances.
 - ⇒ Ensure adequate ventilation.
 - ⇒ Use fire-resistant materials or heat shields.

Danger due to sharp edges

- Lacerations
- Short circuit due to electrical wire damage
- ▶ Fit protectors on sharp edges.

3.4 Using this document

Before installing and operating the heater, read this installation documentation, the installation instructions of the heater, the operating instructions and supplementary sheets provided.

3.4.1 Explanatory Notes on the Document

There is an identification mark near the respective work step to allow you to quickly allocate the other applicable documents to the Webasto components to be installed:

| | |
|---|--|
| Generally valid Webasto documentation | |
| Vehicle-specific installation documentation | |
| Webasto Comfort A/C control | |
| Webasto Standard A/C control | |
| Tank extracting device (e.g. FuelFix) | |
| Exhaust end fastener (EFIX) | |
| Combustion air intake silencer | |
| Spacer bracket (ASH) | |

3.4.2 Use of symbols



DANGER

Type and source of the risk

Consequences: Failure to follow the instructions can result in death

► Actions to protect yourself against risks.



WARNING

Type and source of the risk

Consequences: Failure to follow the instructions can lead to serious or even fatal injuries

► Actions to protect yourself against risks.



CAUTION

Type and source of the risk

Consequences: Failure to follow the instructions can lead to minor injuries

► Actions to protect yourself against risks.



Type and source of the risk

Consequences: Failure to follow the instructions can lead to material damage

► Actions to protect yourself against risks.



Reference to the vehicle manufacturer's specific documents.



a note on a special technical feature

3.4.3 Work step identification marks

The ongoing work step is indicated on the outside top corner of the page:

| | | | |
|-------------------|-------------------|--------------|----------|
| Mechanical system | Electrical System | High-voltage | Coolant |
| | | | |
| Combustion air | Fuel | Exhaust gas | Software |
| | | | |

3.4.4 Orientation aid

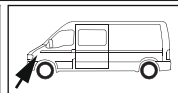
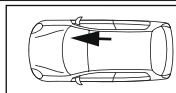

The arrow indicates the position on the vehicle and the viewing angle

3.4.5 Use of highlighting

| Highlight | Explanation |
|---|---|
| ► | Necessary action |
| ⇒ | Result of an action |
| 1 / 12 / a1 / A | Position numbers for the image descriptions |
| 1 / 12 | Position numbers for the image descriptions for electrical wires and wiring harnesses and coolant hose sections |

4 Technical Information

Dimension specifications

- All dimensions specified in mm

Tightening torque specifications

- Tightening torque values of 5x13 heater bolts and 5x11 heater stud bolts = 8Nm
- Tightening torque values of 5x15 retaining plate of water connection piece bolts = 7Nm
- 5x12 bolt tightening torque of 2-part heater bracket = 6Nm
- Tighten other bolt connections in accordance with manufacturer's instructions or in accordance with state-of-the-art-technology

Specified temperature for fabric heat shrink plastic tubing

- Shrink temperature max. 230°C

Necessary special tools

- Hose clamp pliers for self-clamping hose clamps
- Hose clamp pliers for Clic hose clamps of type W
- Hose clamping pliers
- Hose cutter
- Automatic wire stripper 0.2 - 6 mm²
- Crimping pliers for cable lugs 0.5 – 10 mm²
- Crimping pliers for tab connector 0.14 – 6 mm²
- Crimping pliers for connector 0.25 – 6 mm²
- Torque wrench for 2.0 - 10 Nm
- Deep-hole marker
- Metric thread-setter kit
- Webasto Thermo Test Diagnosis with current software

5 Preparing measures

5.1 Vehicle preparation



Further information can be found in the vehicle manufacturer's technical documentation.

- ▶ Open the fuel tank cap
- ▶ Ventilate the fuel tank
- ▶ Close the fuel tank cap again
- ▶ Depressurise the cooling system
- ▶ Disconnect the battery (located under the spare wheel in the boot)
- ▶ Remove the cover between the bumper and the radiator carrier
- ▶ Remove the air filter together with the intake hose
- ▶ Remove the windscreen wipers
- ▶ Remove the coolant reservoir cap
- ▶ Remove the strut brace on the right
- ▶ Remove the right front wheel
- ▶ Remove the right-hand wheel well trim
- ▶ Remove the underride protection on the right (3x)
- ▶ Remove the lower engine cover (3x)
- ▶ Remove the A/C control panel
- ▶ Remove the instrument panel trim on the left and right
- ▶ Remove the lower instrument panel trim on the left
- ▶ Split bench seat: remove the right rear seat (attached with bolts)
- ▶ Remove the full-width bench seat (attached with clips)
- ▶ Open the tank-fitting service lid on the right

Carry out the following work only during the corresponding installation sequence:



DANGER

Risk of fire and explosion due to leaking fuel and escaping fuel vapours.

- ▶ Detach the tank fitting

5.2 Heater preparation



Observe the general installation instructions of the heater.

- ▶ Remove years that do not apply from the type and duplicate label.
- ▶ Attach the duplicate label (type label) in the appropriate place in the engine compartment.

6 Installation overview

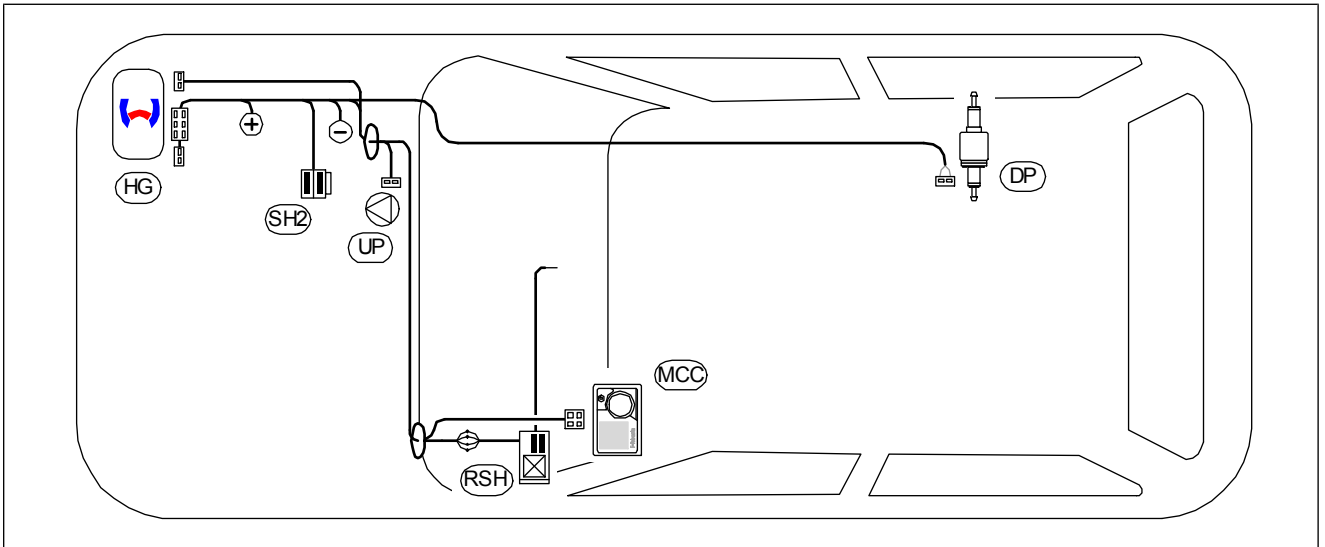
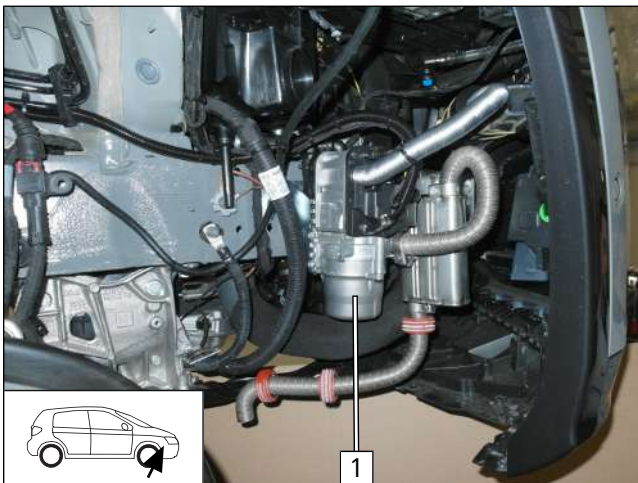

Fig. 1

Legend to installation overview

| Abbreviation | Component |
|--------------|--|
| DP | Fuel pump |
| HG | Heater |
| MCC | MultiControl CAR |
| SH2 | Engine compartment fuse holder |
| RSH | Relay and fuse holder of passenger compartment |
| UP | Coolant pump |

Heater installation location



1 Heater

Fig. 2



7 Electrical system of engine compartment

Premounting fuse holder

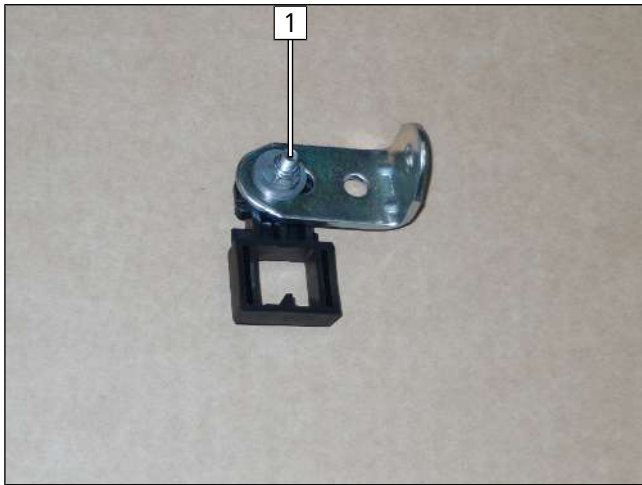

Fig. 3

- 1 M5x16 bolt, large diameter washer, fuse holder, angle bracket, large diameter washer, nut

Installing large diameter washer

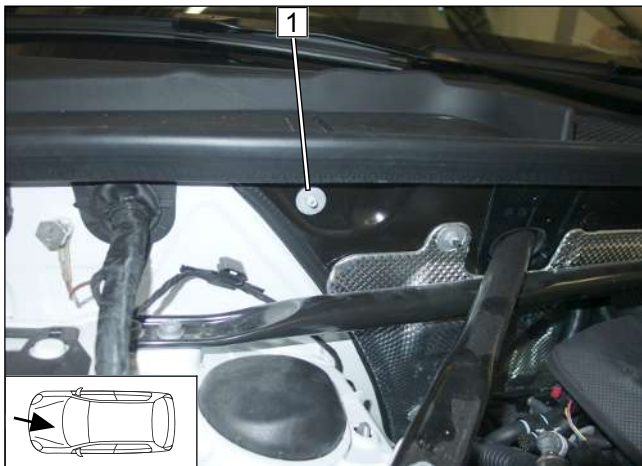

Fig. 4

- Position 21.6mm dia. large diameter washer 1 onto original veh. stud bolt.

Mounting fuses F1 and F2

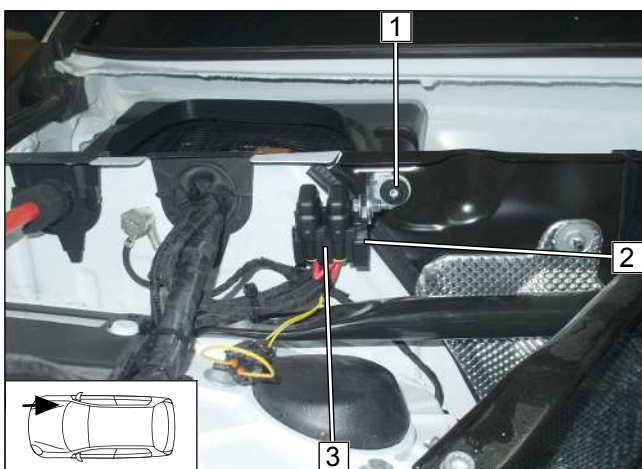

Fig. 5

- 1 Original vehicle stud bolt and plastic nut
- 2 Premounted retaining plate
- 3 Fuse F1: 20A and F2: 30A



Installing positive wire on positive support point

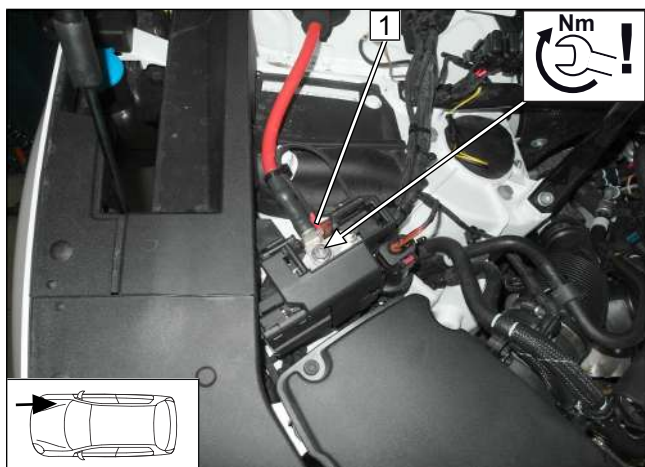

Fig. 6



DANGER

Fire hazard due to insufficient tightening torque

- Observe tightening torque

- 1** Red (rt) positive wire

Earth connection

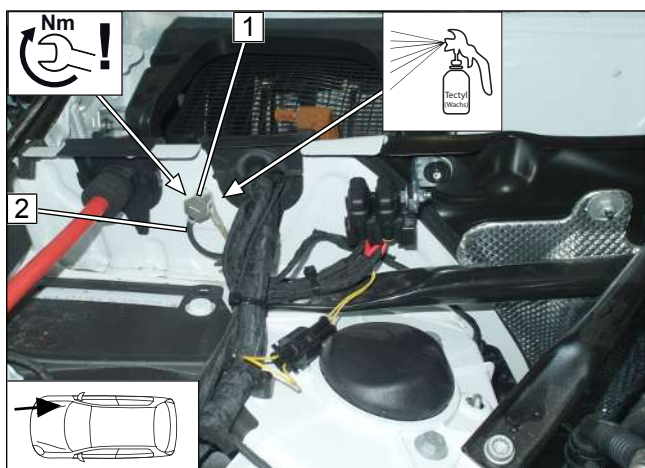

Fig. 7



DANGER

Fire hazard due to insufficient tightening torque

- Observe tightening torque

- 1** Original vehicle earth point

- 2** Brown (br) earth wire

Wiring harness routing in coolant reservoir and to driver's side



Fig. 8



Danger of damage to wiring harnesses

- Ensure sufficient distance from windscreen wiper linkage

- Route wiring harness **1** (heater, coolant pump and control element) through protective rubber plug **3** in the coolant reservoir to the driver's side.
- Position coolant pump wiring harness connector **2** as shown.



Passenger compartment wiring harness pass through

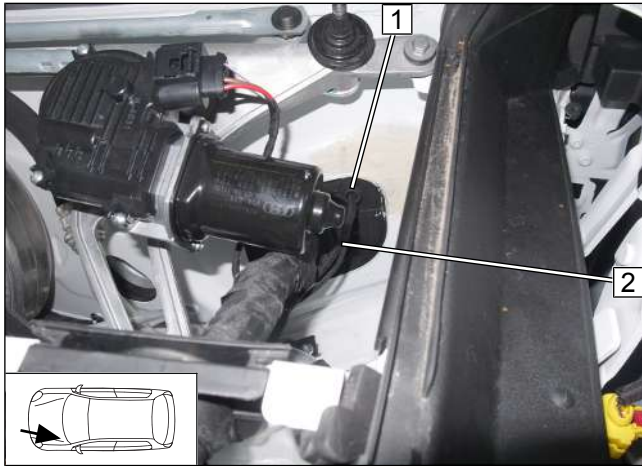

- 1** Protective rubber plug
- 2** Heater and control element wiring harness

Fig. 9



8 Mechanical system

8.1 Installation location preparation

Cutting off tab

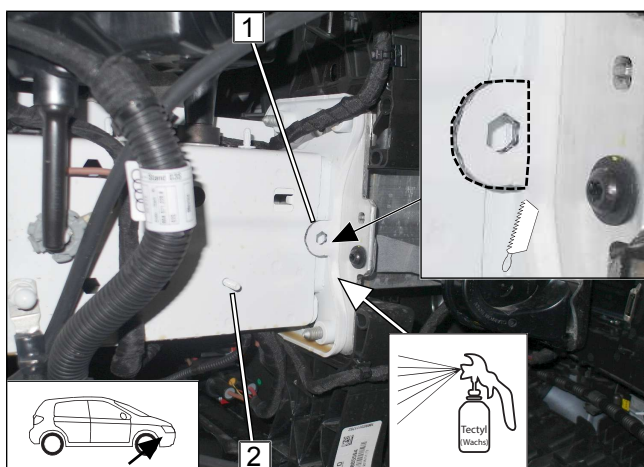

Fig. 10

- ▶ Cut off tab at position **1** as shown.
- 2** Shorten original vehicle stud bolt by 5mm for the subsequent assembly of the heater bracket

Copying hole pattern

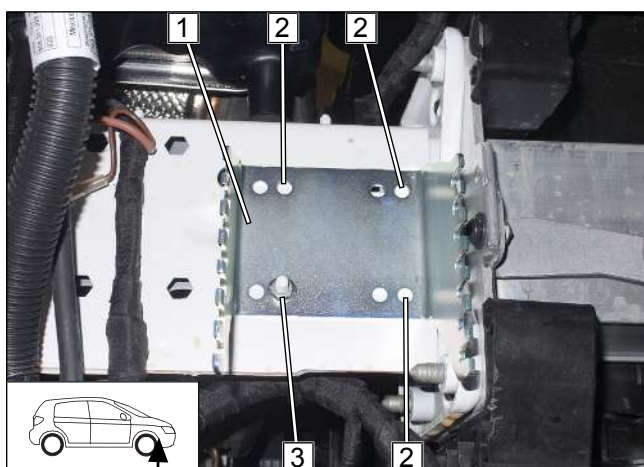

Fig. 11

- ▶ Align bracket **1** horizontally as shown.
- 2** Hole pattern
- 3** Original vehicle stud bolt, M6 flanged nut

Installing rivet nuts

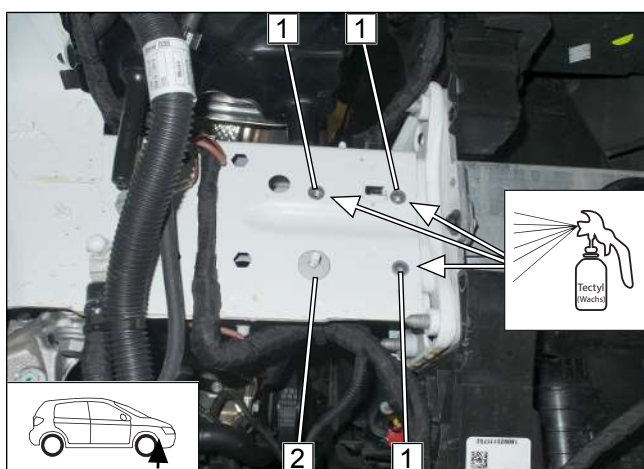

Fig. 12

- 1** 9mm dia. hole, rivet nut
- 2** Pre-mount 21.6mm dia. large diameter washer



Mounting bracket

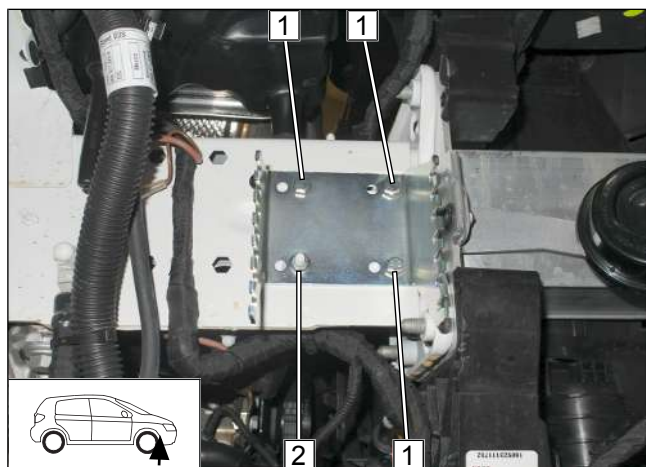

Fig. 13

- 1 M6x20 bolt, spring lockwasher
- 2 M6 flanged nut

8.2 Premounting heater

Installing water connection piece

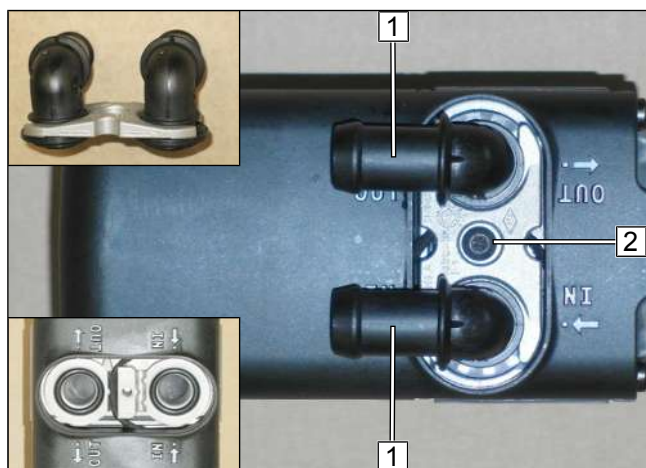

Fig. 14



Observe the general installation instructions of the heater.

- 1 Water connection piece, sealing ring
- 2 5x15 self-tapping bolt, retaining plate of water connection piece

Cutting hoses to length

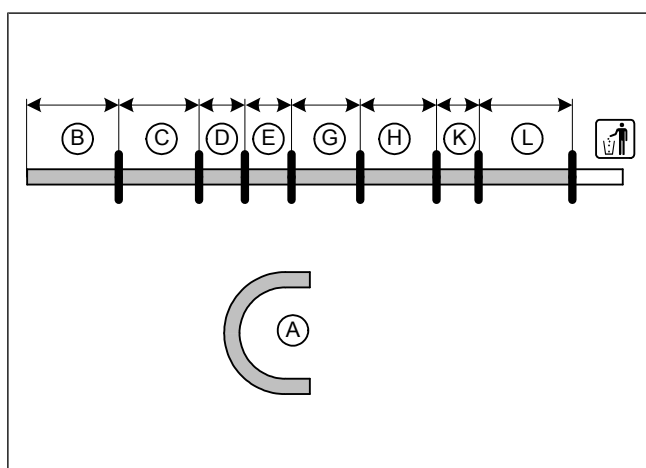

Fig. 15

| | 2.0 D | 3.0 D |
|---|-----------------|-------|
| A | 180°, 18mm dia. | - |
| B | 130 | 110 |
| C | 110 | 110 |
| D | 80 | - |
| E | 80 | - |
| G | 110 | - |
| H | 110 | - |
| K | 90 | - |
| L | 290 | - |



Premounting hoses

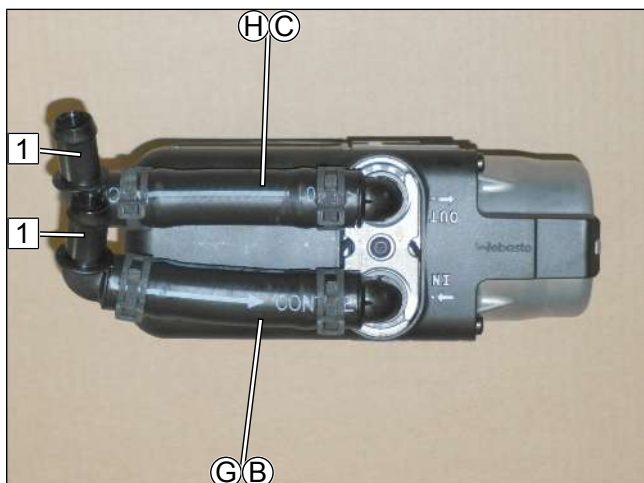

Fig. 16



H / G for 2.0 D
B / C for 3.0 D



All spring clips, 25mm dia.

1 18x18 / 90° connecting pipe

Premounting bolts

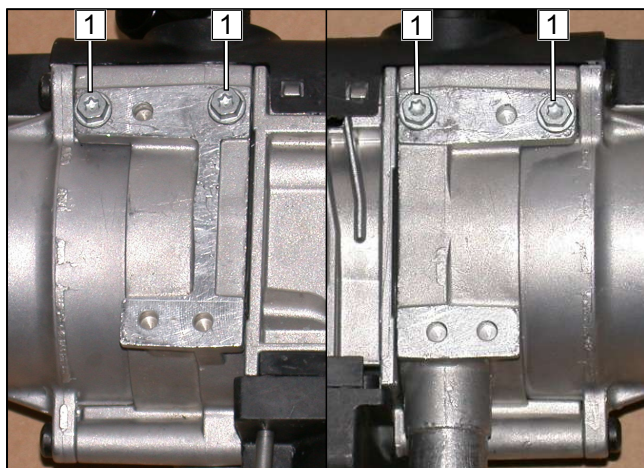

Fig. 17

► Screw 5x13 self-tapping bolt **1** in available holes by a max. of 3 thread turns.

Bending angle bracket

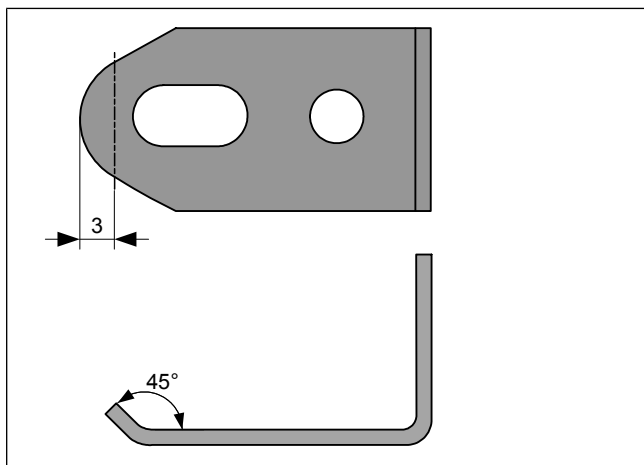

Fig. 18



Installing angle bracket



Fig. 19

- 1 5x13 self-tapping bolt
- 2 Angle bracket

8.3 Heater installation

Mounting heater

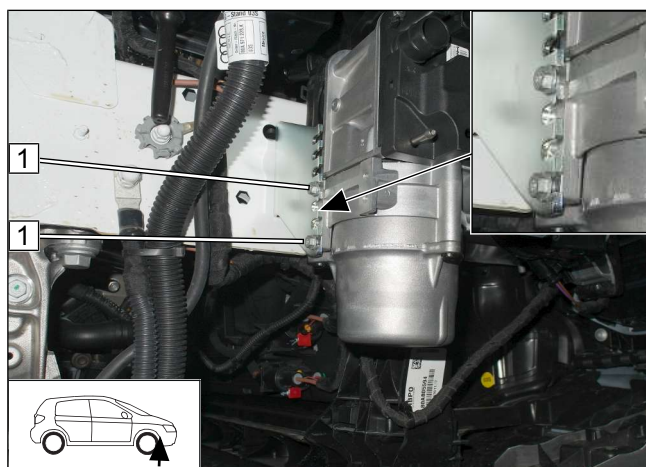



Fig. 20

 Observe the general installation instructions of the heater.

- Tighten 5x13 self-tapping bolt 1.

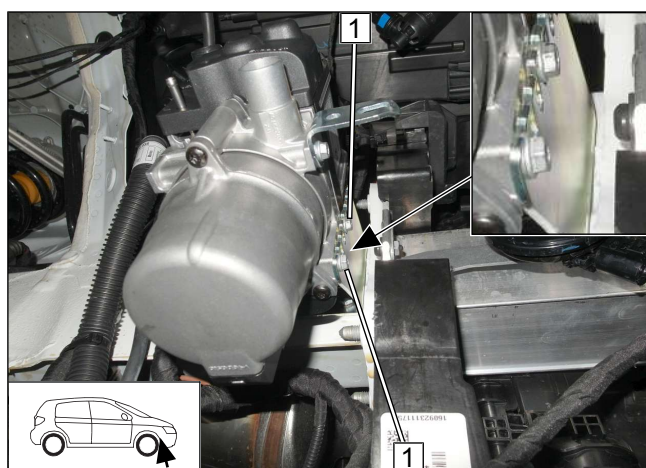



Fig. 21

 Observe the general installation instructions of the heater.

- Tighten 5x13 self-tapping bolt 1.



Mounting wiring harnesses

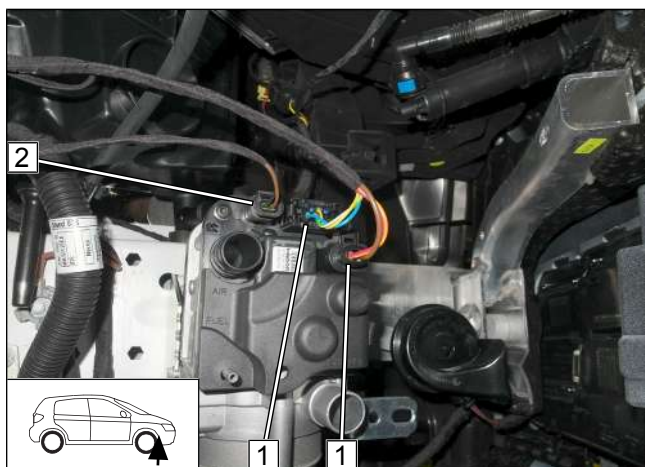

- 1 Heater wiring harness connector
- 2 Coolant pump wiring harness connector

Fig. 22



9 Fuel



DANGER

Risk of fire and explosion due to leaking fuel and escaping fuel vapours.

The Incorrect installation of the fuel extractor can cause damage and fire.

- ▶ Avoid electrostatic discharges and open fire.
- ▶ When working on the fuel system, ensure sufficient ventilation and bleeding.
- ▶ Open the fuel tank cap of the vehicle.
- ▶ Ventilate the fuel tank
- ▶ Re-close the tank lock.
- ▶ Catch any fuel running off with an appropriate container.



Danger of damage to components

- ▶ Install fuel line and fuel pump wiring harness so that they are protected against stone impact.
- ▶ Provide rub protection for fuel line and wiring harness in areas where there are sharp edges.

Dismantling fuel pump connector

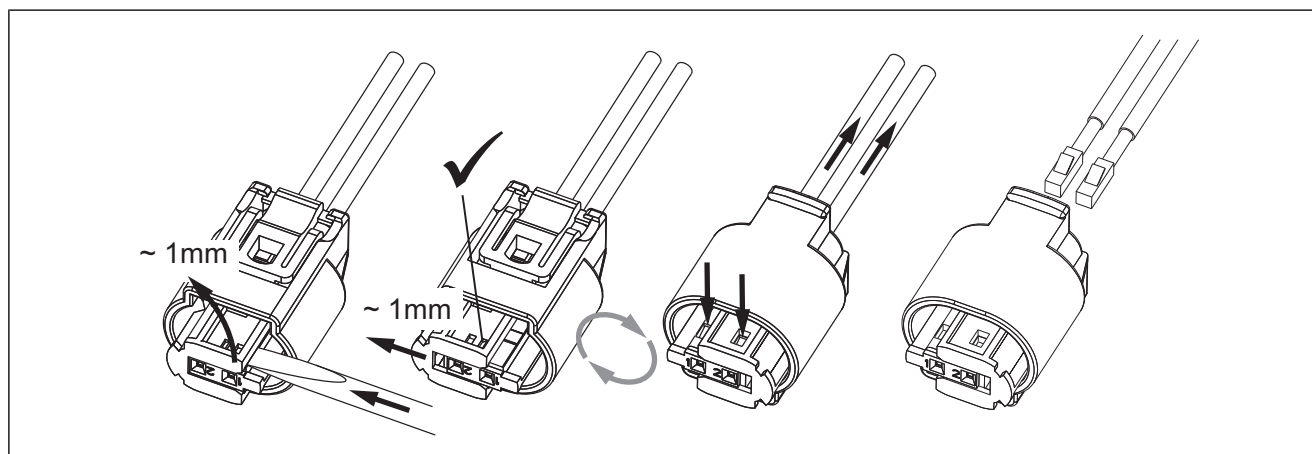
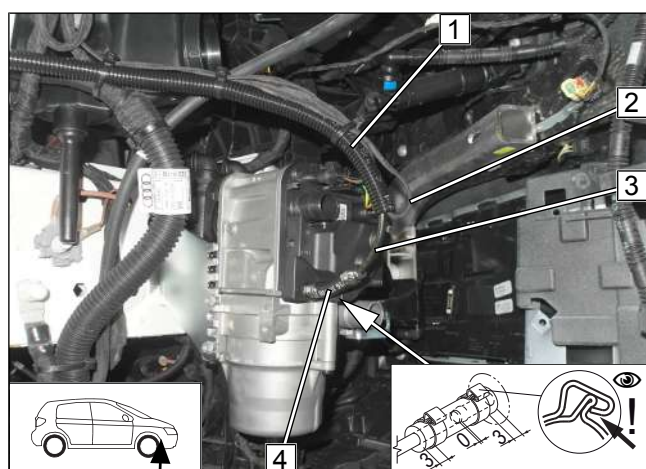

Fig. 23

Connection to heater



- 1 Fuel line and fuel pump wiring harness in 10mm dia. corrugated tube
- 2 Fuel pump wiring harness
- 3 Fuel line
- 4 Hose section, 10mm dia. clamp [2x]

Fig. 24



Routing in wheel well

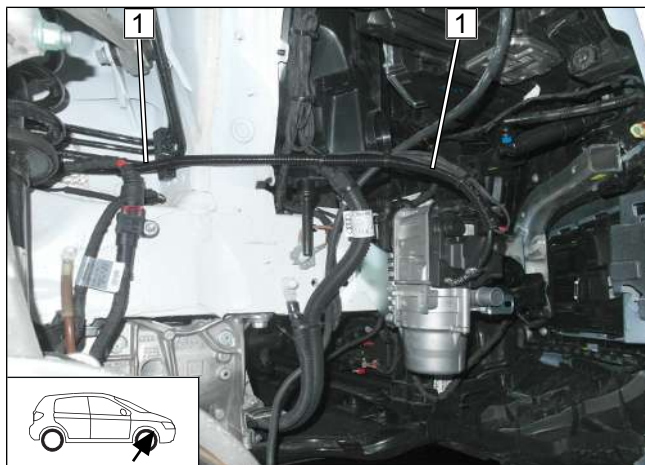

Fig. 25

- 1 Fuel line and fuel pump wiring harness in corrugated tube

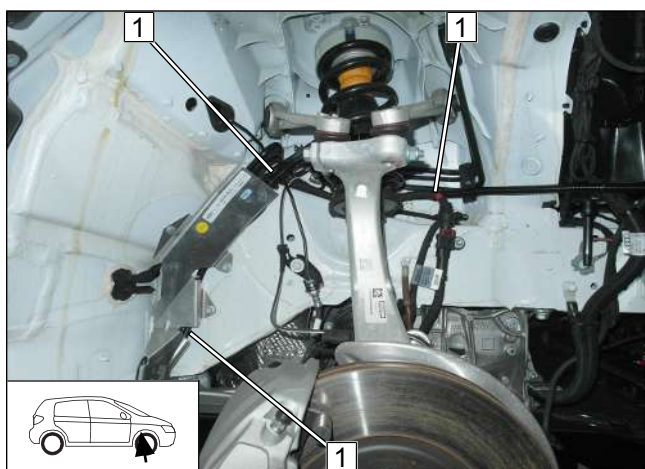

Fig. 26

- Route fuel line and fuel pump wiring harness in corrugated tube 1 to the underbody.

Routing on underbody

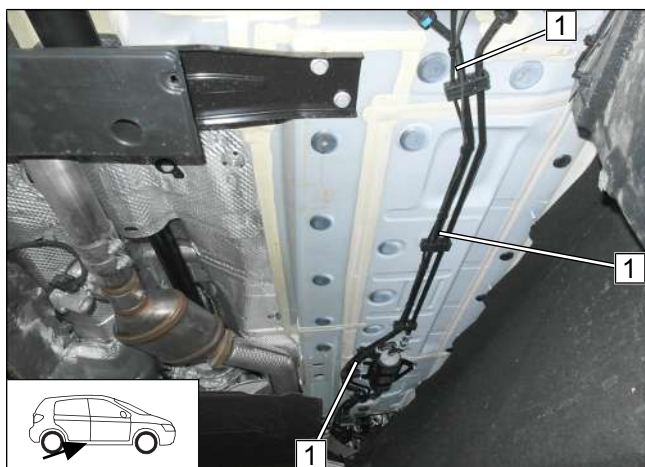

Fig. 27

- Route fuel line and fuel pump wiring harness 1 on the underbody along the original vehicle fuel line to the installation location of the fuel pump.



Preparing perforated bracket

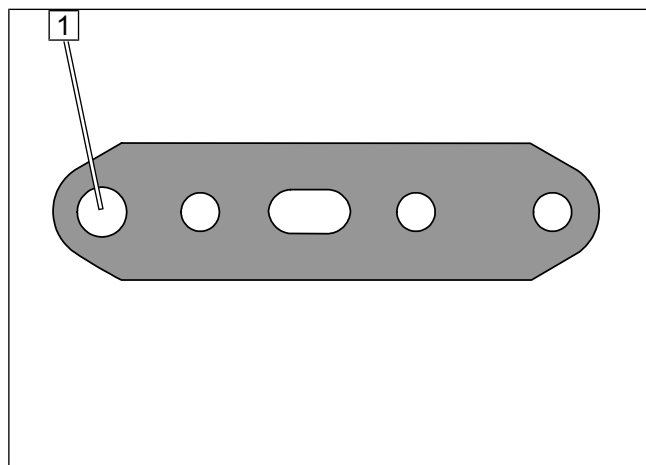

Fig. 28

- 1 Enlarge hole to 10mm dia.

Premounting fuel pump

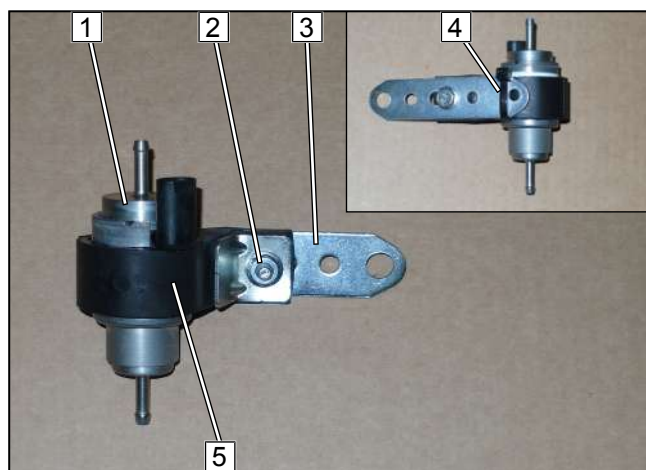

Fig. 29

- 1 Fuel pump
- 2 M6x25 bolt, support angle bracket, flanged nut
- 3 Perforated bracket
- 4 Cable tie, passed through mount of fuel pump
- 5 Fuel pump mount

Mounting fuel pump

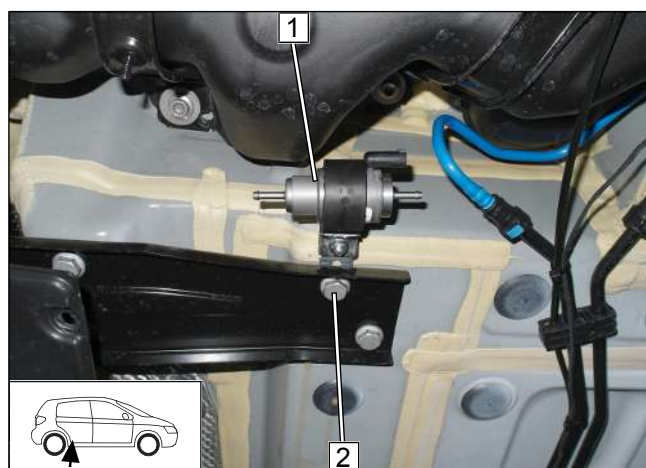

Fig. 30

- 1 Premounted fuel pump
- 2 Original vehicle bolt



Mounting fuel pump connector

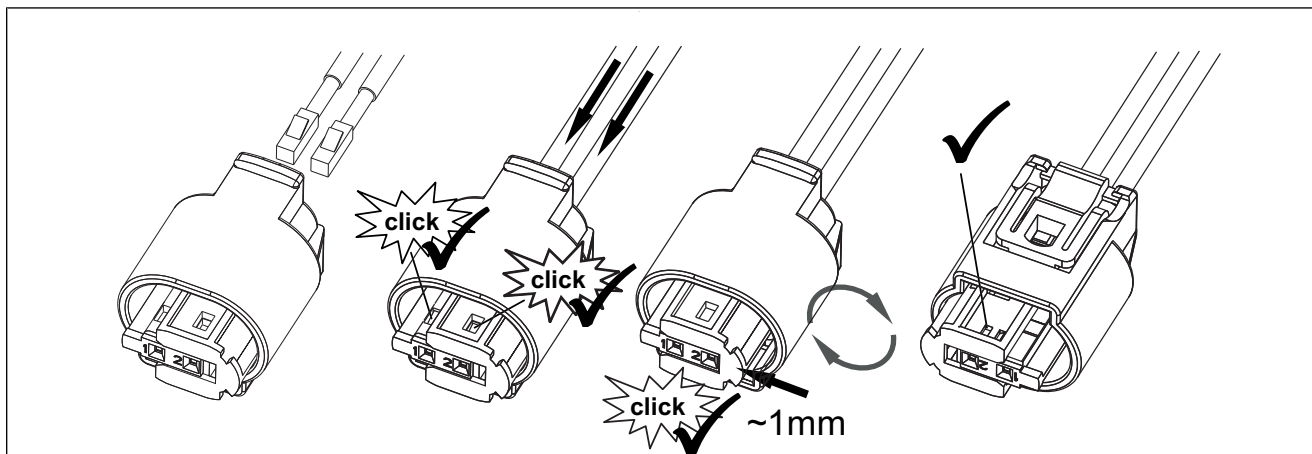
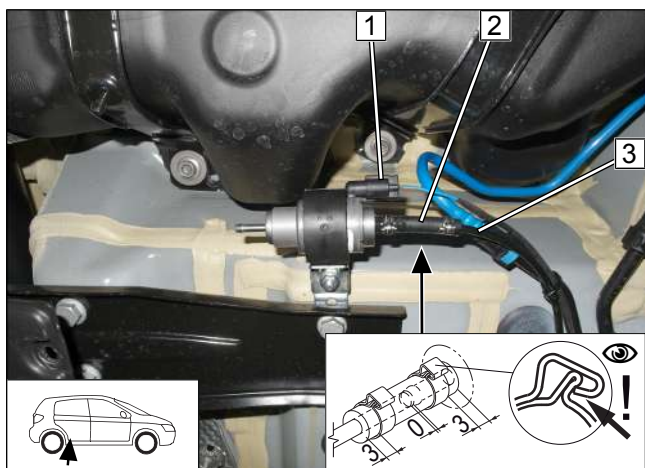

Fig. 31

Fuel pump connection



- 1 Fuel pump wiring harness, connector X7 mounted
- 2 Hose section, 10mm dia. clamp [2x]
- 3 Heater fuel line

Fig. 32

Shortening standpipe

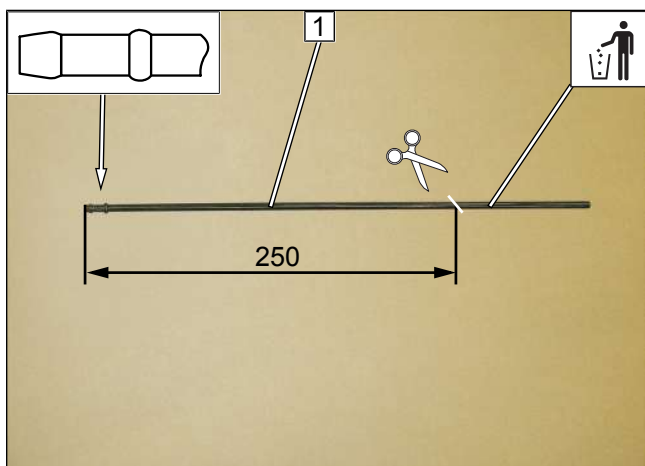

- 1 Standpipe

Fig. 33



Premounting standpipe

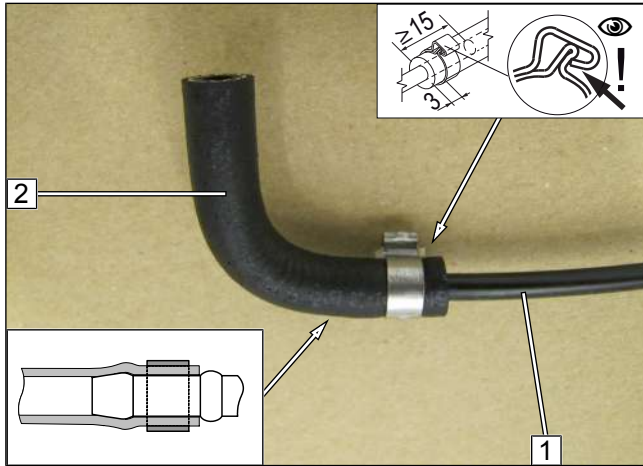

Fig. 34

- 1 Standpipe
- 2 Moulded hose, 10mm dia. clamp

Removing full-width bench seat

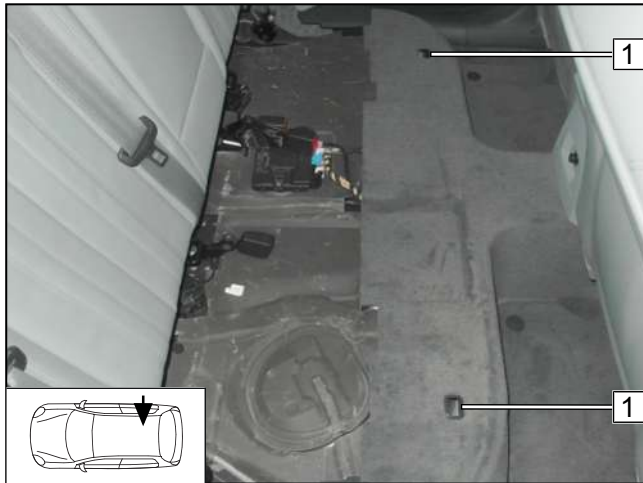

Fig. 35

Version 1

► View of full-width bench seat when removed (attached with clips)

- 1 Bench seat fastening point

Removing rear bench seat on the right

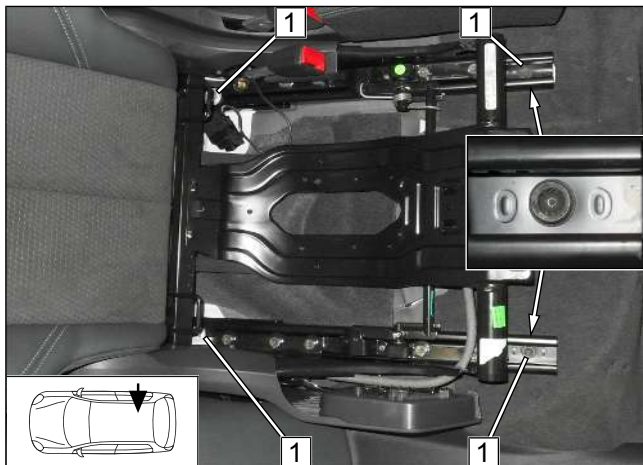

Fig. 36

Version 2

► Remove original vehicle bolts 1 as shown.



Exposing tank fitting

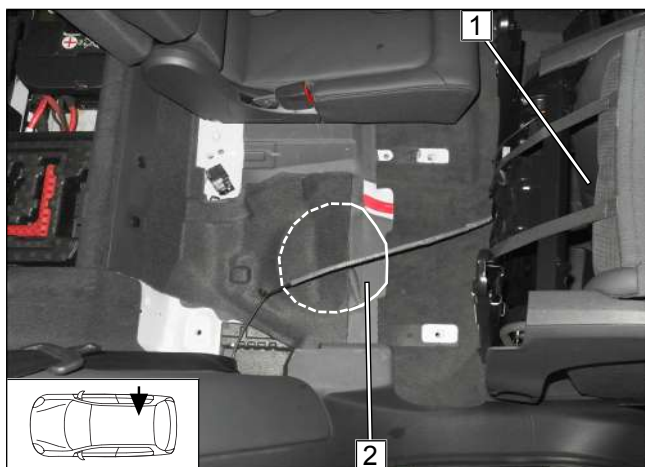

Fig. 37



Figure shows vehicle with split bench seat.

- ▶ Fold down bench seat **1**.
- ▶ Fold back insulation **2** covering the tank fitting.

Adapting tank fitting connection piece

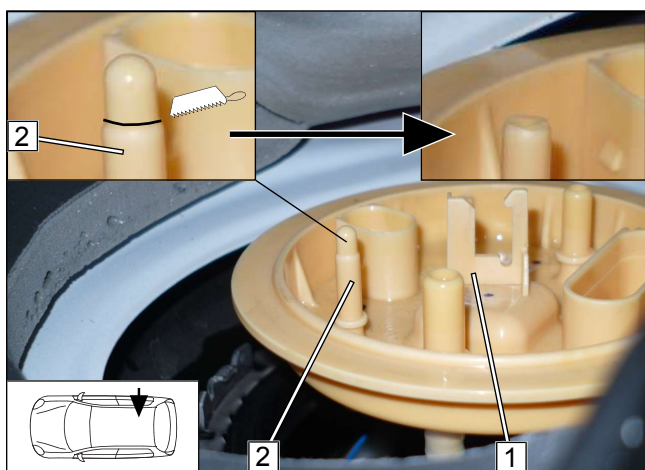

Fig. 38



Further information can be found in the vehicle manufacturer's technical documentation.

- ▶ Detach tank fitting **1**.
- ▶ If there is a cap on connection piece **2**, then cut it carefully as shown.
If there is no cap on connection piece **2**, then drill out the hole to 2.5mm dia.

Installing standpipe

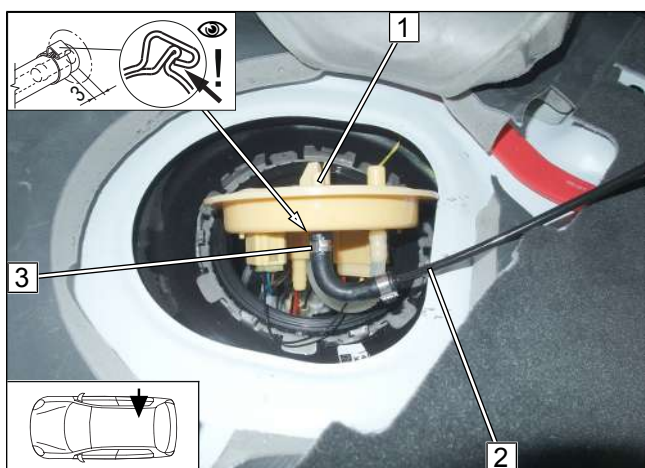

Fig. 39

- 1** Connection piece for tank extracting device
- 2** Premounted standpipe
- 3** 10mm dia. clamp



Inserting standpipe

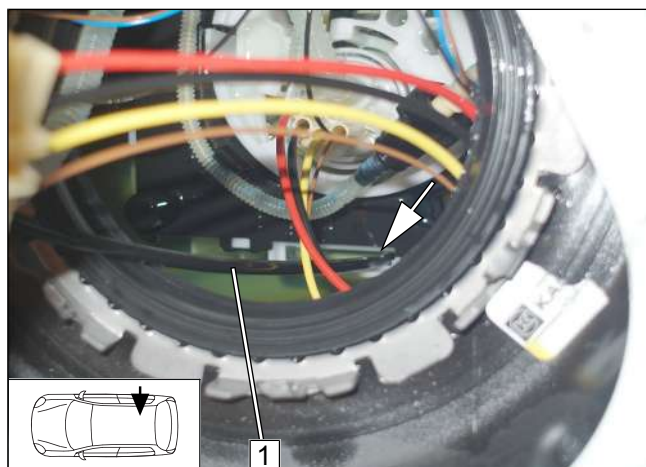

Fig. 40

► Insert standpipe **1** as shown.

Installing coupling piece

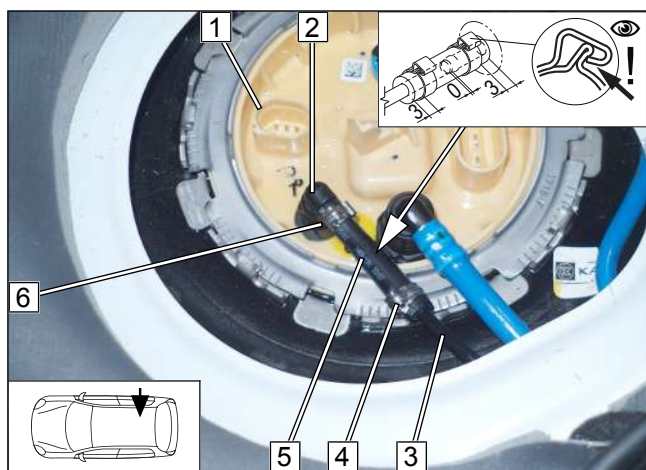



Fig. 41

 Further information can be found in the vehicle manufacturer's technical documentation.

► Install tank fitting **1**.

- 2** Coupling piece
- 3** Fuel line of tank extracting device
- 4** 10mm dia. clamp
- 5** 3.5 mm moulded hose x 4.5 mm dia.; 3.5 mm dia. side on tank extracting device
- 6** 8mm dia. clamp

Fuel pump connection

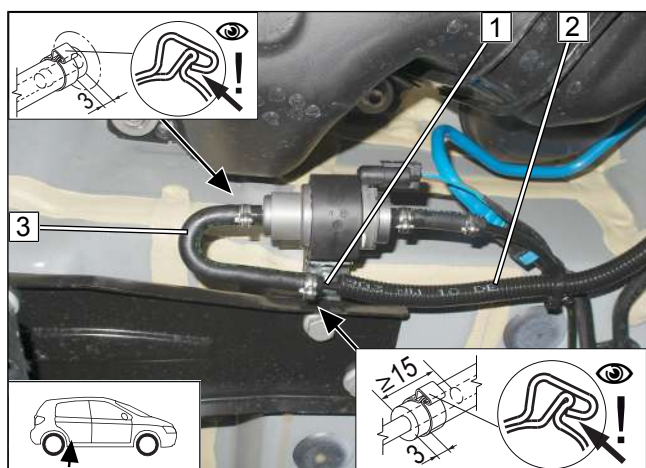



Fig. 42

 **Danger of damage to components**
Attach corrugated tube to original vehicle lines using cable ties.

► Draw fuel line of tank extracting device **1** into 10mm dia. corrugated tube **2**.

- 3** 180° moulded hose, 10mm dia. clamp [2x]



10 Combustion air

Installing combustion air intake silencer

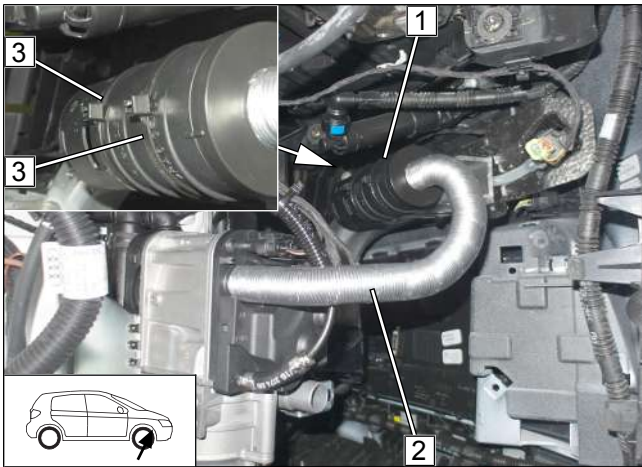

Fig. 43



Observe the installation instructions of the combustion air intake silencer.

► Attach combustion air intake silencer **1** to carrier using cable tie **3** [2x].

2 Combustion air pipe



11.2 Coolant circuit installation

Cutting hoses to length

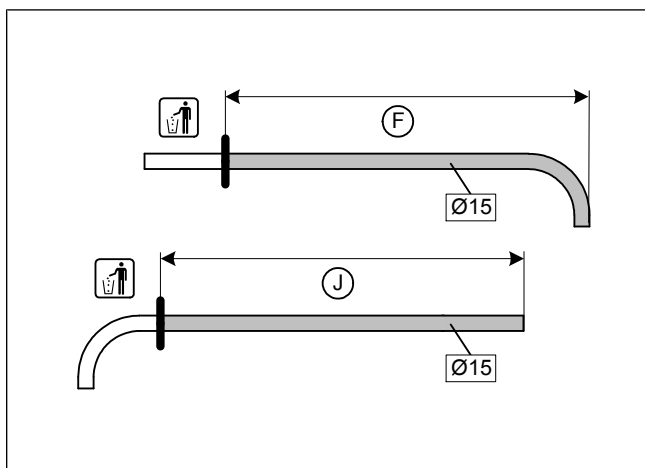

Fig. 45

► Hoses **F** and **J** = 90° moulded hose

| | |
|----------|-----|
| F | 690 |
| J | 750 |

Preparing hoses **F** and **J**

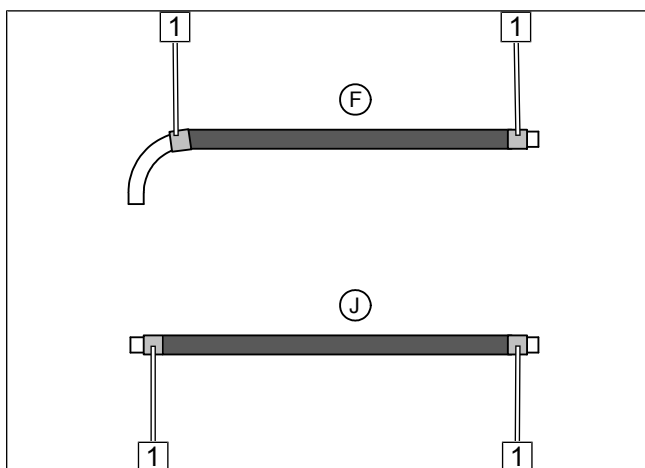

Fig. 46

► Slide on and cut to length braided protection hoses.

- 1 Cut heat shrink plastic tubing to length, 50mm long

Dismantling pass through

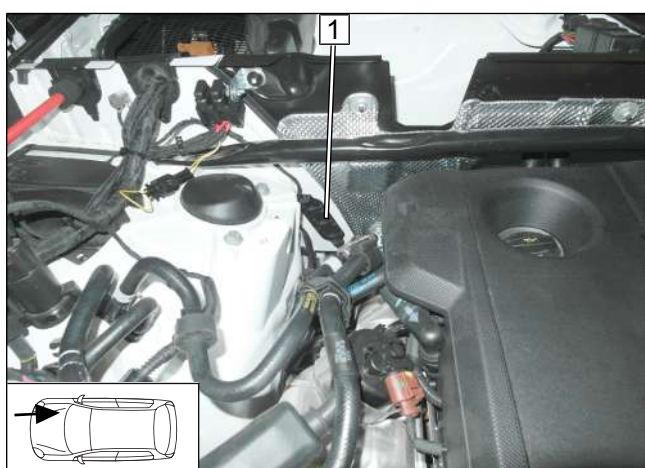

Fig. 47

- 1 Pass through



Adapting pass through

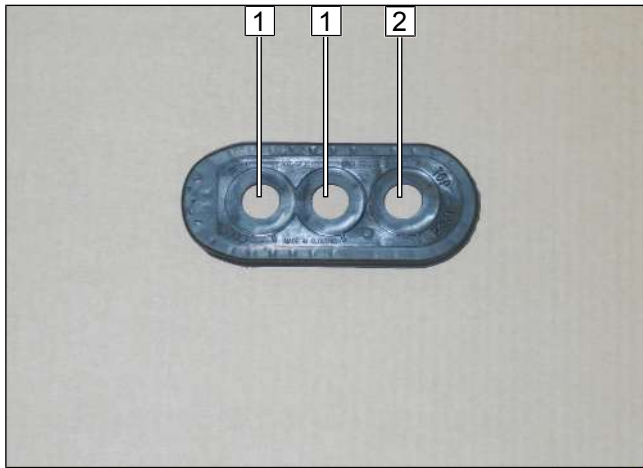

Fig. 48

- 1 18mm dia. hole
- 2 Original vehicle hole, if present

Premounting hoses **F** and **J**

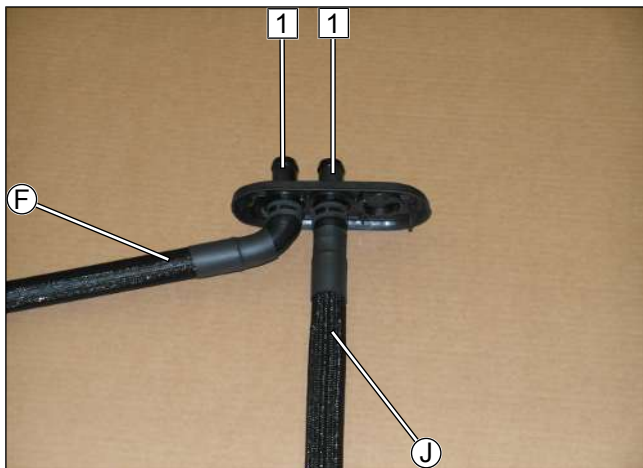

Fig. 49

- All spring clips 22mm dia.
- 1 15/18 connecting pipe

Installing edge protection and edge clip cable tie

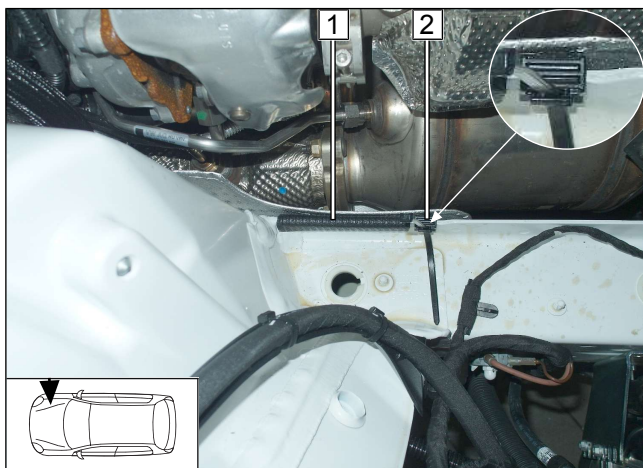

Fig. 50

- 1 80mm lg. edge protection
- 2 Edge clip cable tie



Install pass through with hoses **F** and **J**

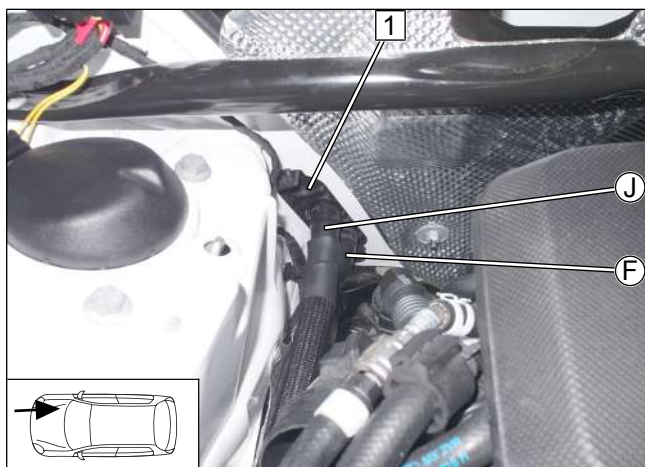

Fig. 51

► Route hose **F** behind the heat guard plate to the heater.

1 Pass through

Cutting heat protection hose to length

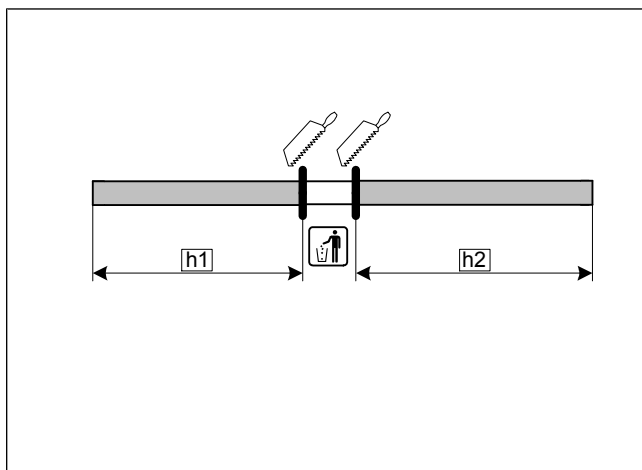

Fig. 52

h1 150

h2 250

Route and connect hose **F**

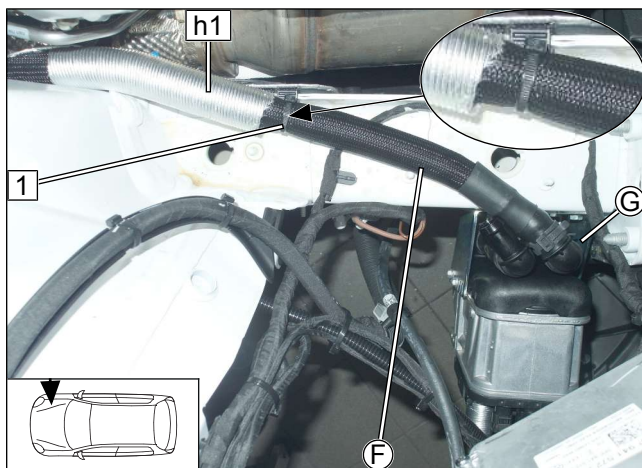

Fig. 53

► Install and align heat protection hose **h1**.

1 Tighten edge clip cable tie



Preparing bracket

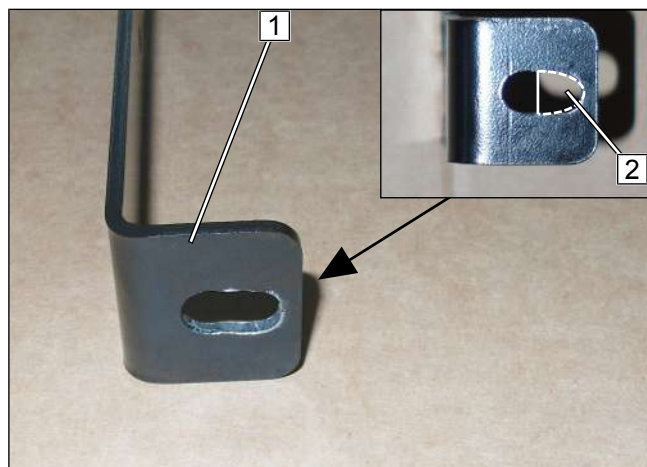

Fig. 54

- ▶ Adapt oblong hole **2** in bracket **1** as shown (e.g. by using a file).

Routing hose J

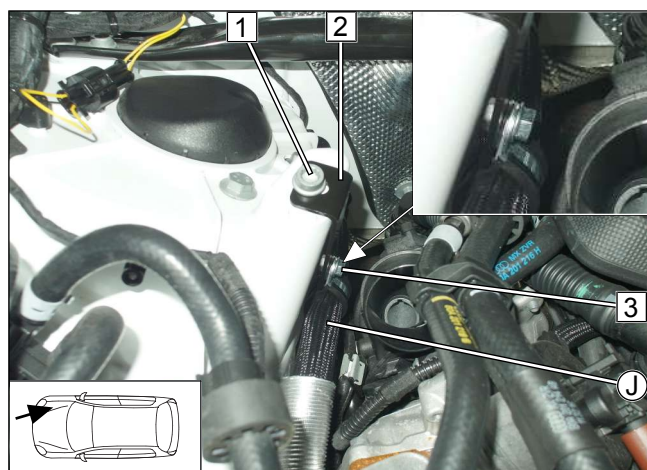

Fig. 55

- 1** Mount original vehicle bolt loosely
- 2** Bracket
- 3** M6x12 bolt, 25mm dia. rubber-coated p-clamp, M6 flanged nut

Connecting hose J

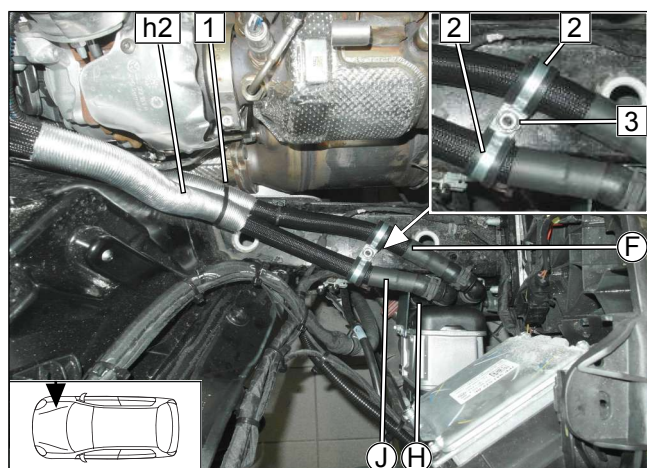

Fig. 56

- ▶ Mount and align heat protection hose **h2**.
- 1** Cable tie
- 2** 25mm dia. rubber-coated p-clamp
- 3** Original vehicle stud bolt, flanged nut



Installing coolant pump

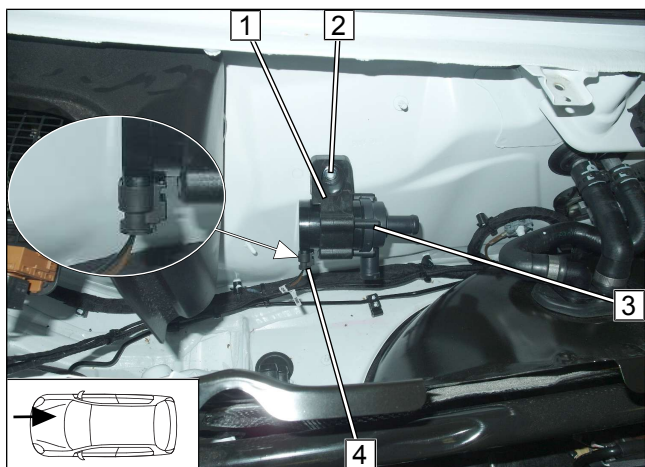

Fig. 57

- 1 Coolant pump mount
- 2 Original vehicle stud bolt, flanged nut
- 3 Coolant pump
- 4 Coolant pump wiring harness connector

Premounting hoses

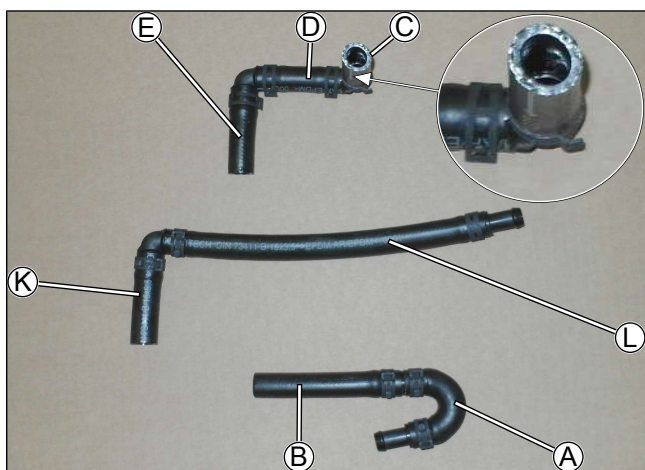

Fig. 58

Cutting point



Fig. 59

► Cut engine outlet / heat exchanger inlet hose at the marking.

- 1 Heat exchanger inlet hose section
- 2 Engine outlet hose section



Connecting coolant pump

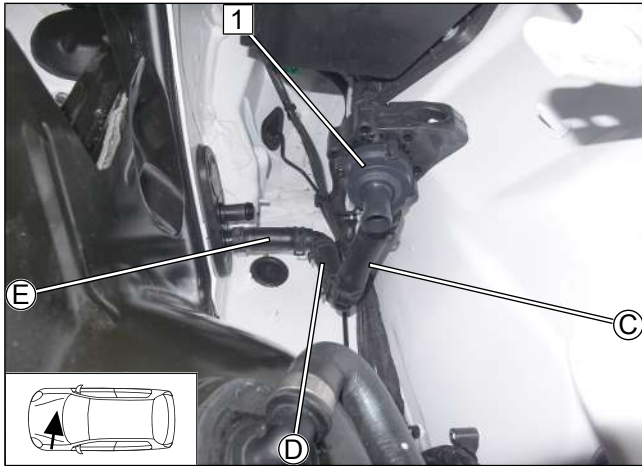

Fig. 60

1 Coolant pump

Connecting heat exchanger inlet

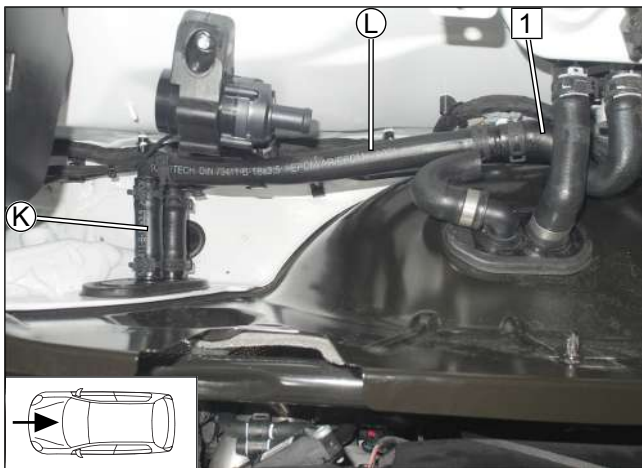

Fig. 61

1 Heat exchanger inlet hose section

Installing hose bracket



Fig. 62

1 Hose bracket



Connecting engine outlet

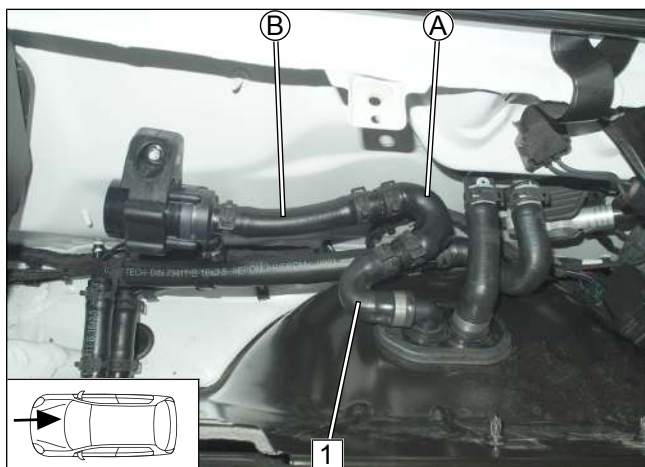

Fig. 63

- 1 Engine outlet hose section

Installing hose bracket

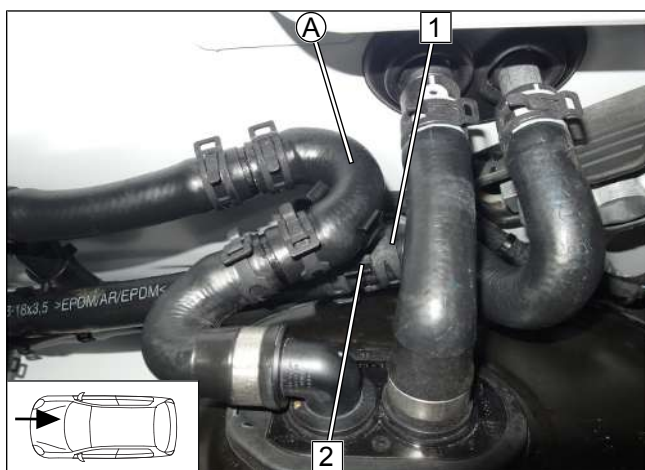

Fig. 64

- 1 Heat exchanger inlet hose section
- 2 Hose bracket

Installing fuse and relay box



Fig. 65



Danger of damage to components
► Ensure sufficient distance from neighbouring components, correct if necessary.

- 1 Fuse and relay box



Checking distance

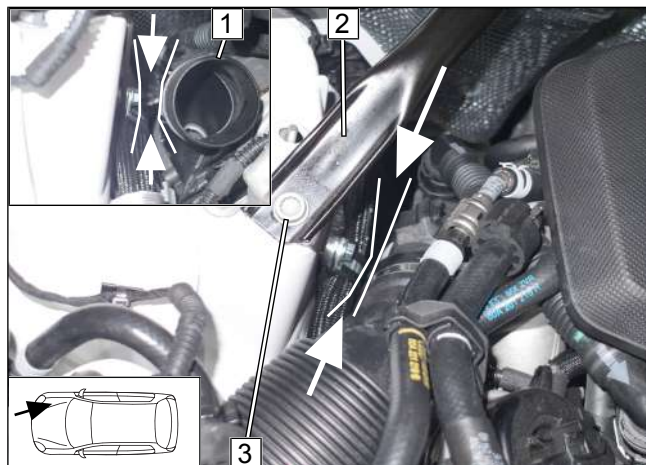

Fig. 66



Ensure sufficient distance from neighbouring components, correct if necessary.



- Mount strut brace **2** and tighten original vehicle bolt **3**.

1 Engine intake hose



12 Coolant for 3.0 D vehicles

12.1 Hose routing diagram

'Inline' coolant circuit

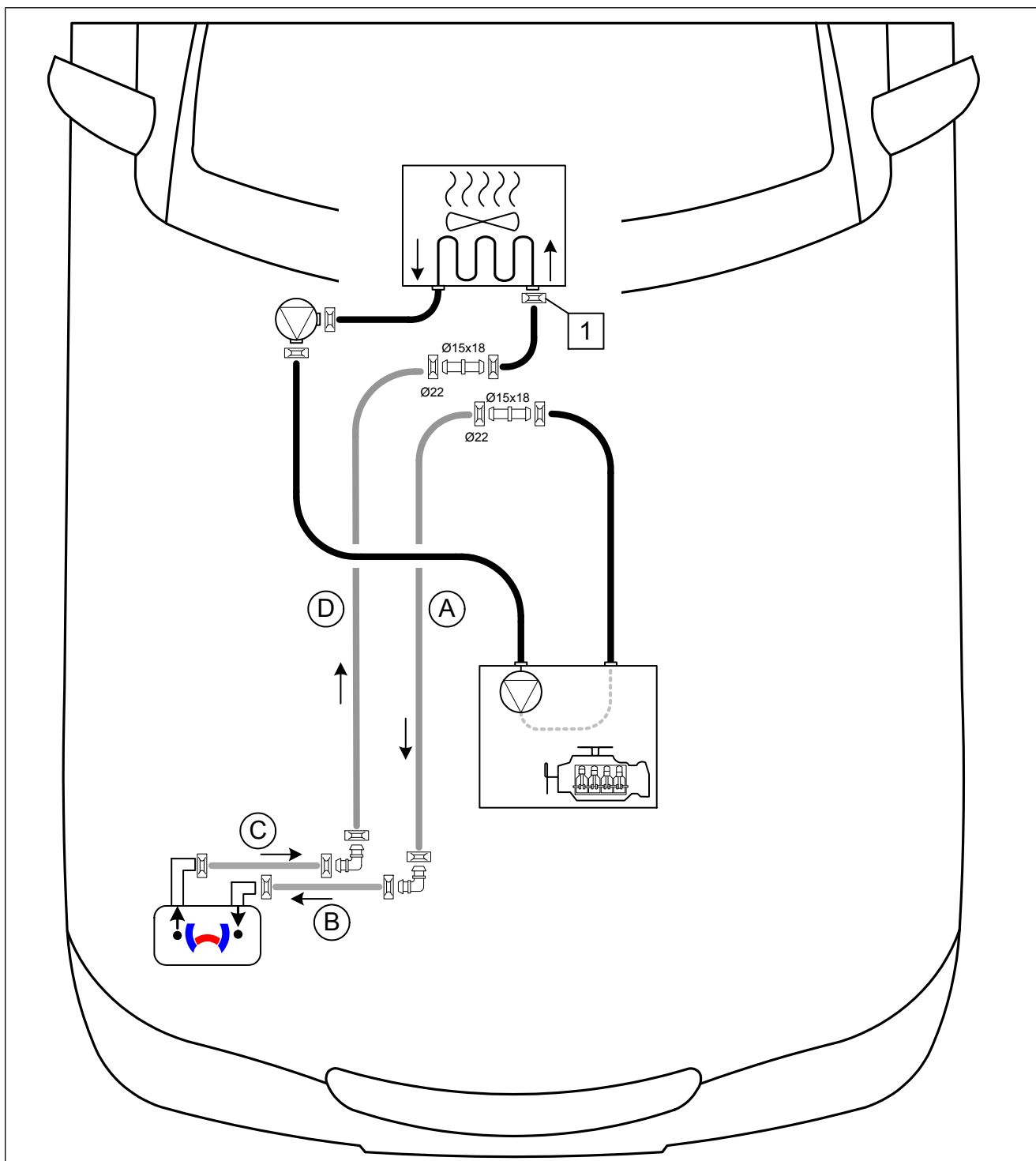

Fig. 67

All spring clips without a specific designation  = 25mm dia.

All connecting pipes without a specific designation  = 18x18mm dia.

1 Original vehicle spring clip



12.2 Coolant circuit installation

12.2.1 Connection in coolant reservoir

Installing coolant pump

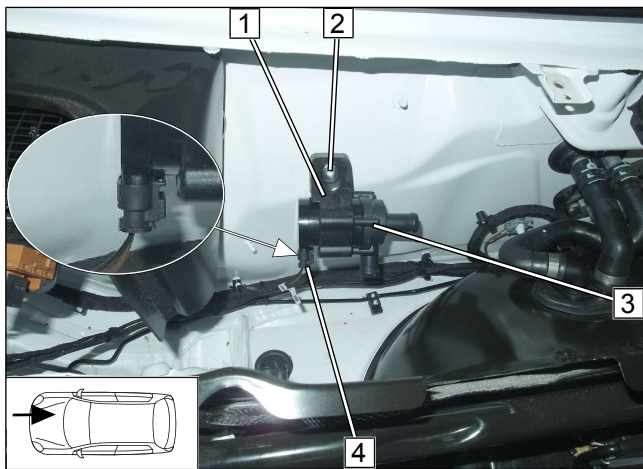

Fig. 68

- 1 Coolant pump mount
- 2 Original vehicle stud bolt, flanged nut
- 3 Coolant pump
- 4 Coolant pump wiring harness connector

Removing heat shrink plastic tubing

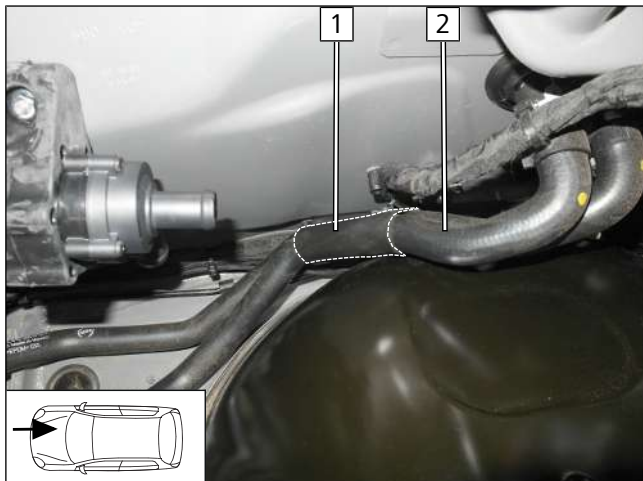

Fig. 69

- 1 Heat shrink plastic tubing
- 2 Heat exchanger outlet / engine inlet hose

Cutting point

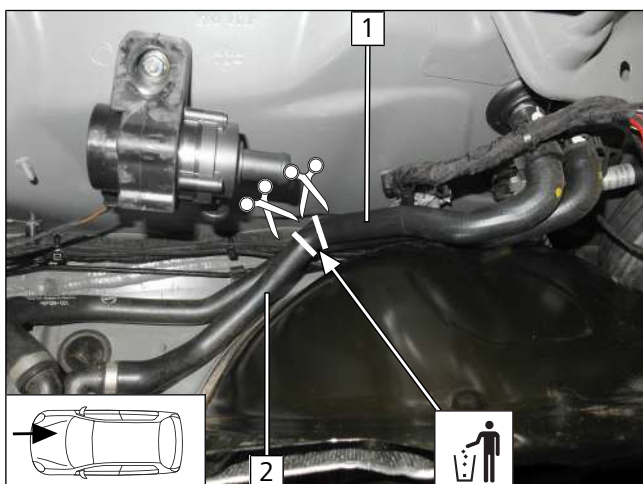

Fig. 70

► Cut heat exchanger outlet / engine inlet hose at the marking.

- 1 Heat exchanger outlet hose section
- 2 Engine inlet hose section



Connecting coolant pump

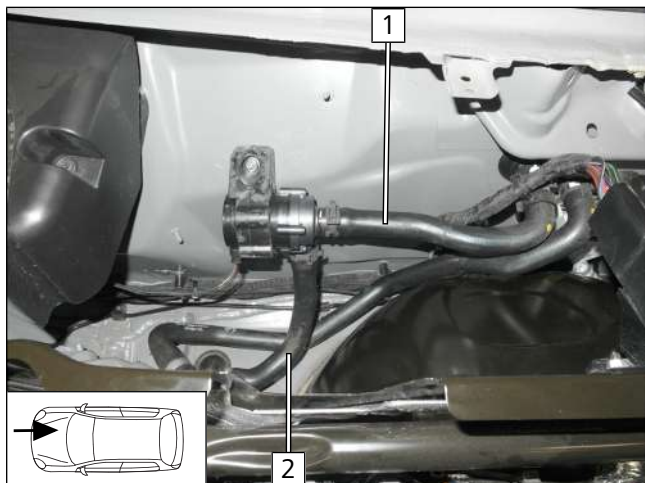

Fig. 71

- 1 Heat exchanger outlet hose section
- 2 Engine inlet hose section

12.2.2 Connection in engine compartment

Cutting hoses to length

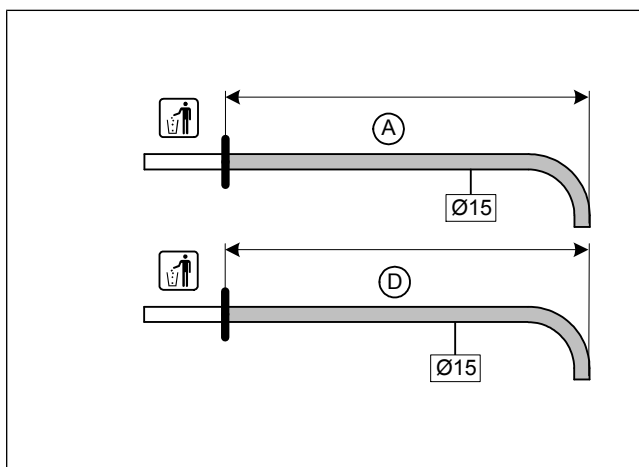

Fig. 72

► Hoses **A** and **D** = 90° moulded hose

| | |
|----------|-----|
| A | 710 |
| D | 640 |

Preparing hoses **A** and **D**

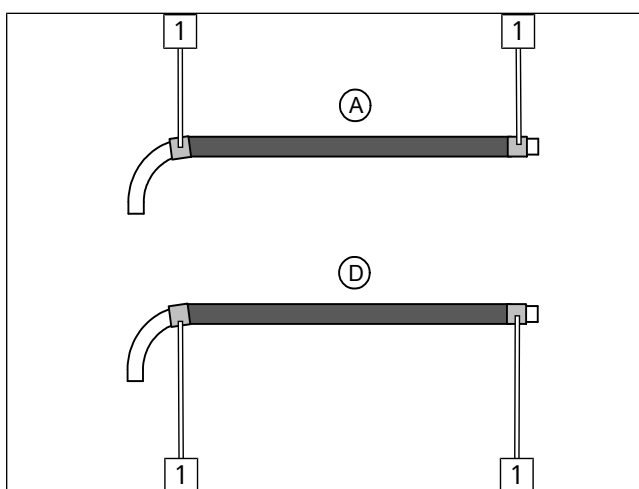

Fig. 73

► Slide on and cut to length braided protection hoses.

- 1 Cut heat shrink plastic tubing to length, 50mm long



Cutting point

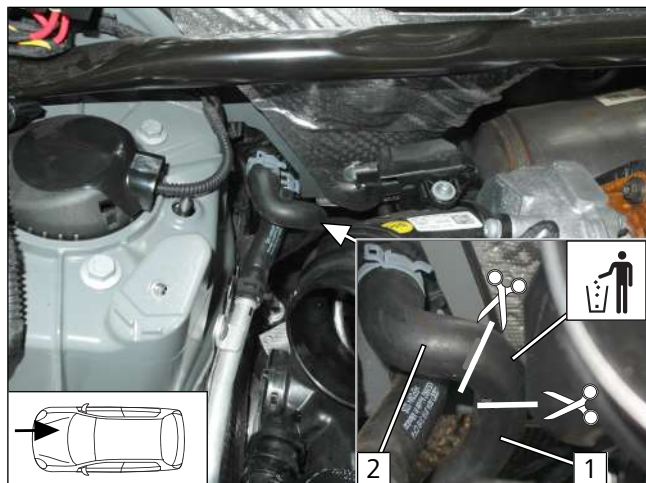

Fig. 74

► Cut heat exchanger inlet / engine outlet hose at the marking.

- 1 Engine outlet hose section
- 2 Dismantle heat exchanger inlet hose section, spring clip will be reused

Mounting connecting pipe onto engine outlet hose section

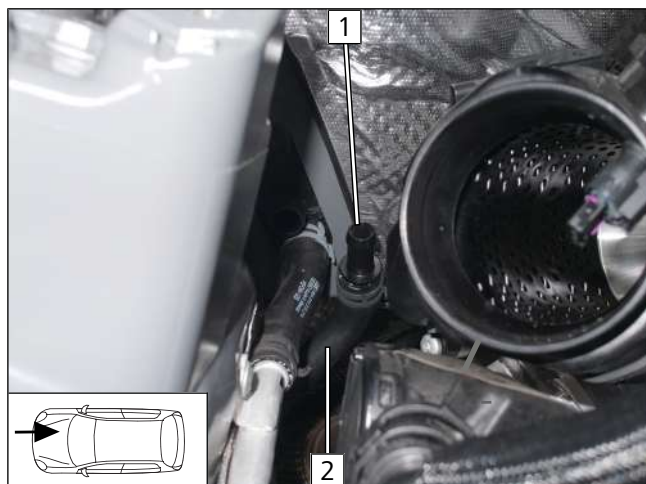

Fig. 75

- 1 15x18mm dia. connecting pipe
- 2 Engine outlet hose section

Mounting hose A

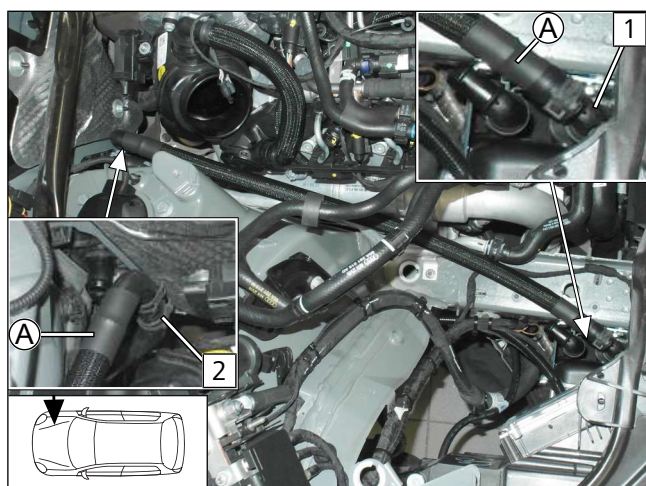

Fig. 76

- 1 Connection to hose B
- 2 Engine outlet hose section



Premounting hose **D**

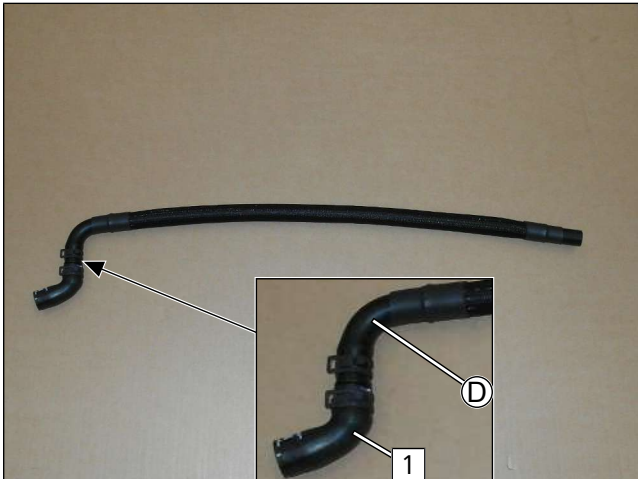

Fig. 77

- 1 Heat exchanger inlet hose section

Mounting hose **D**

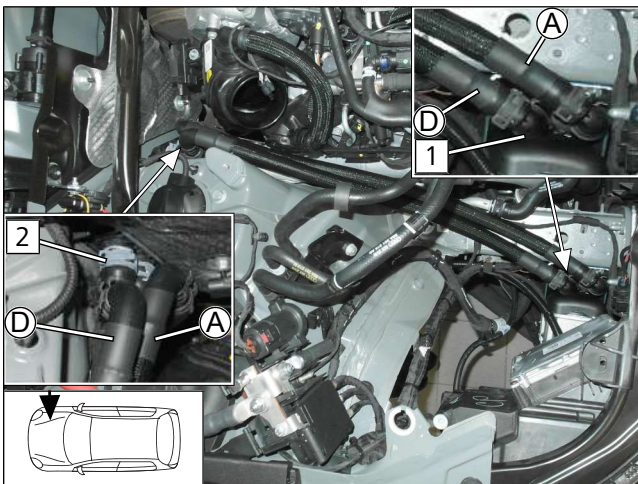

Fig. 78

- 1 Connection to hose **C**
- 2 Heat exchanger inlet connection piece, original vehicle spring clip

Preparing bracket

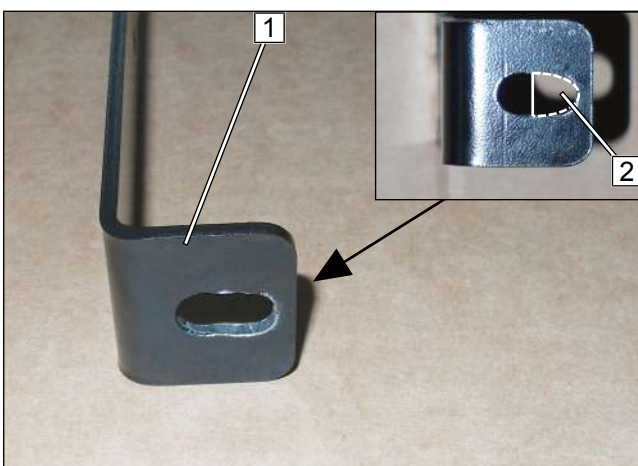

Fig. 79

- Adapt oblong hole **2** in bracket **1** as shown (e.g. by using a file).



Fasten hoses **D** and **A**

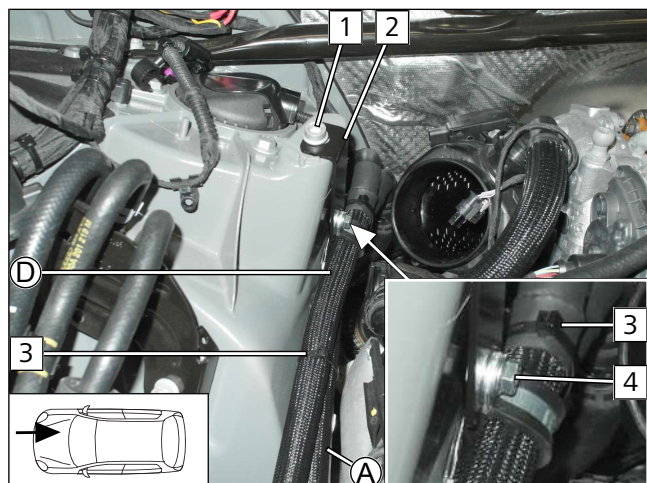

Fig. 80

- 1 Mount original vehicle bolt loosely
- 2 Bracket
- 3 Cable tie
- 4 M6x12 bolt, 25mm dia. rubber-coated p-clamp, flanged nut

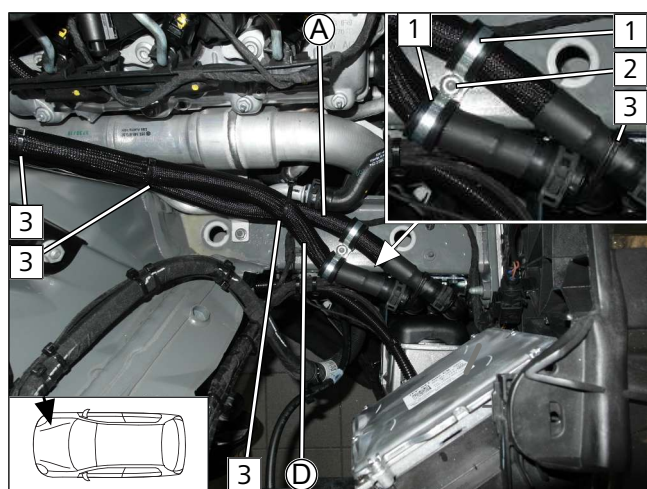

Fig. 81

- 1 25mm dia. rubber-coated p-clamp
- 2 Original vehicle stud bolt, flanged nut
- 3 Cable tie

Checking distance

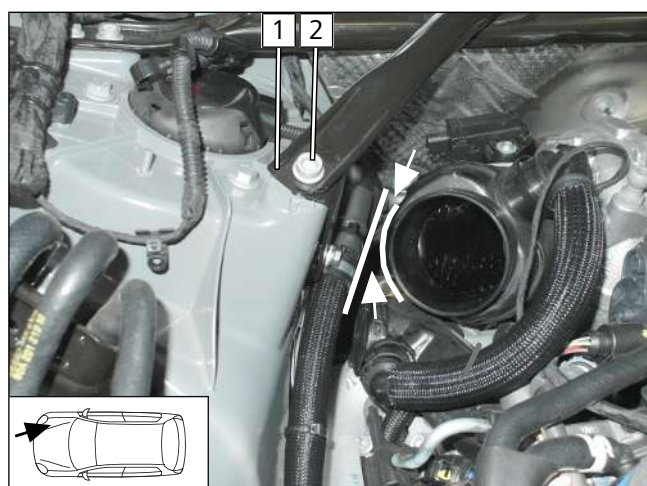

Fig. 82



Ensure sufficient distance from neighbouring components, correct if necessary.



- Mount strut brace **1** and tighten original vehicle bolt **2**.



13 Exhaust

Preparing exhaust pipe

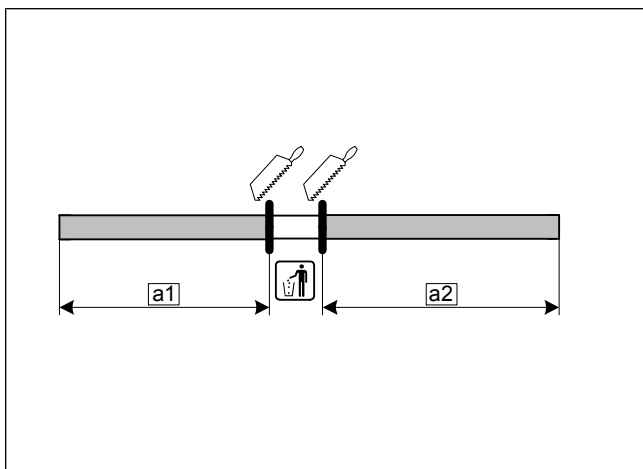

a1 300

a2 390

Fig. 83

Mounting exhaust silencer

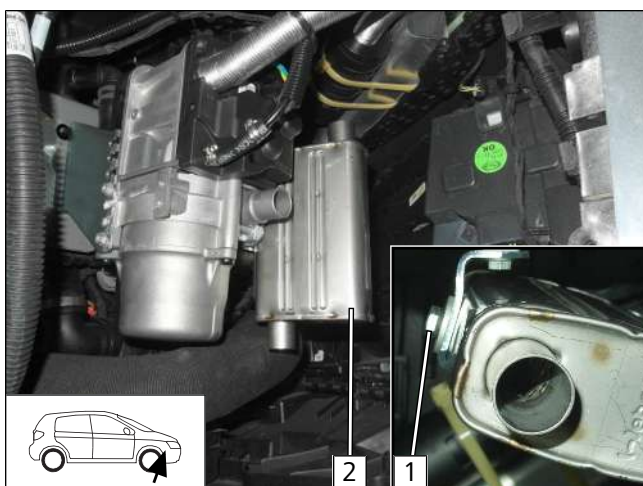

1 M6x16 bolt, spring lockwasher, large diameter washer

2 Exhaust silencer

Fig. 84

Mounting exhaust pipe **a1**

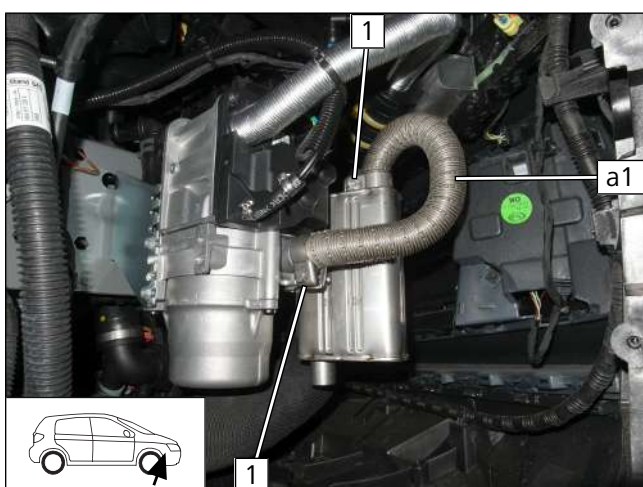

1 Hose clamp

Fig. 85



Mounting exhaust pipe **a2** and ASH

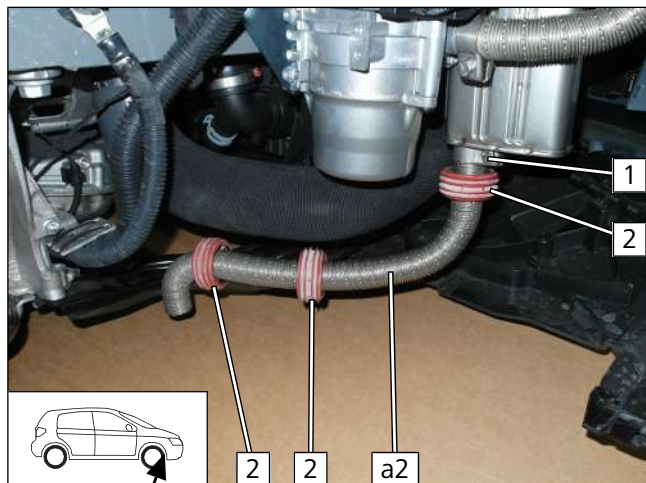

Fig. 86

- 1** Hose clamp
- 2** ASH

Removing cap from underride protection

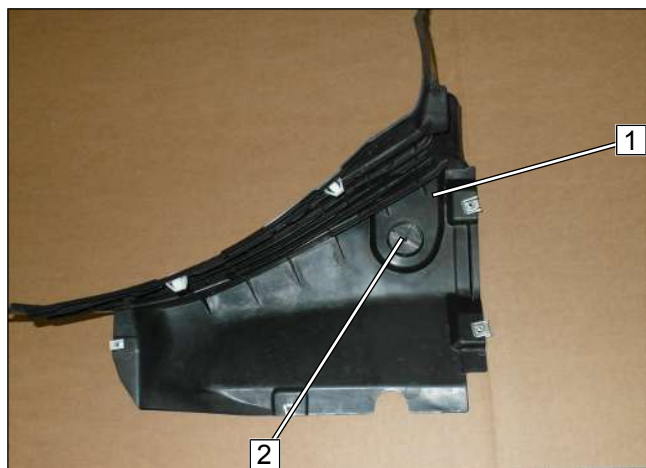

Fig. 87



Observe the EFIX installation instructions.

► Work step E1

- 1** Front right underride protection
- 2** Cap

Copying hole pattern

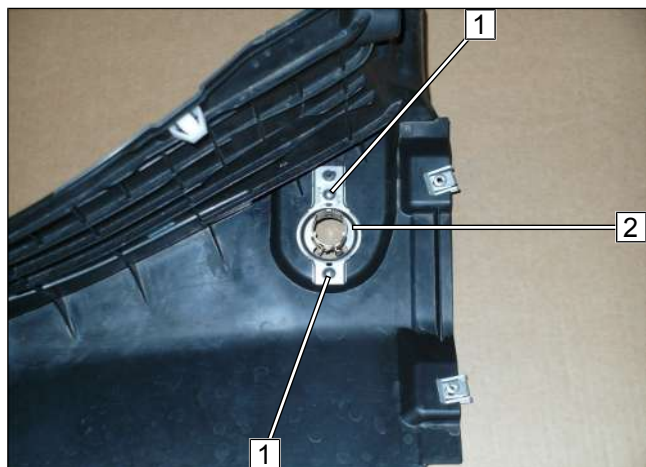

Fig. 88

► Work step E3

► Position EFIX **2** in the middle of the original vehicle hole as shown in Fig..

- 1** Hole pattern



Underride protection, hole for EFIX

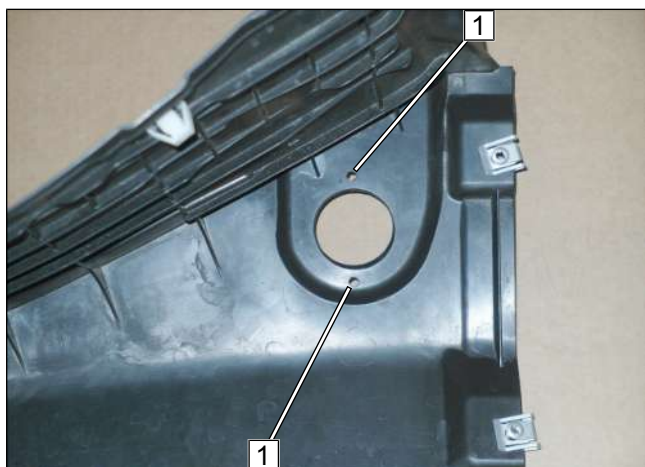

Fig. 89

► Work step E4

- 1 Hole

Mounting EFIX

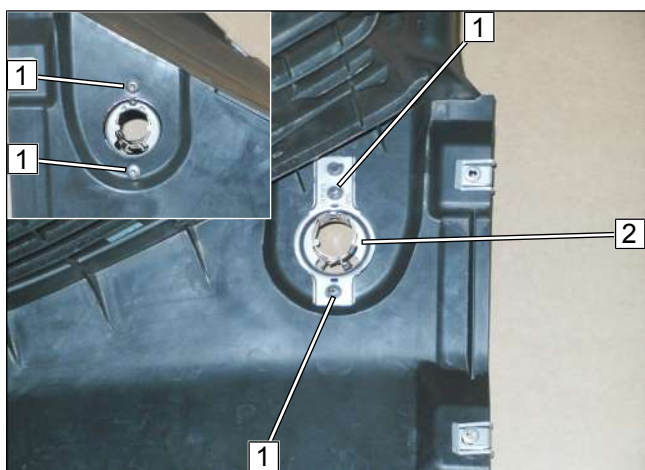

Fig. 90

► Work step E5

- 1 5x13 self-tapping screw
- 2 EFIX

Mounting exhaust pipe **a2** in EFIX

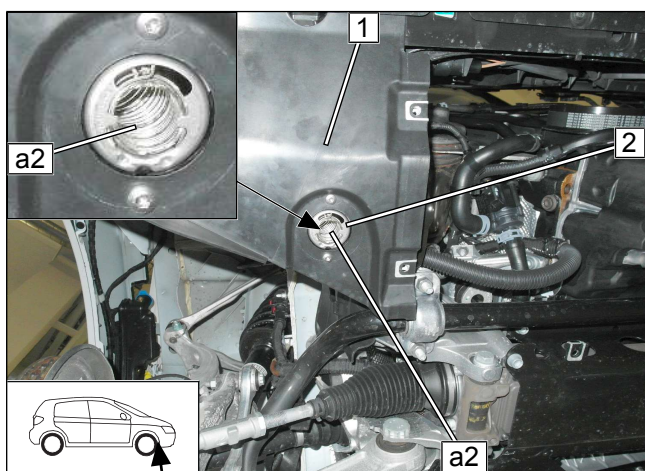

Fig. 91

► Work steps E6-8

► Mount trim **1**.

- 2 EFIX



Aligning ASH

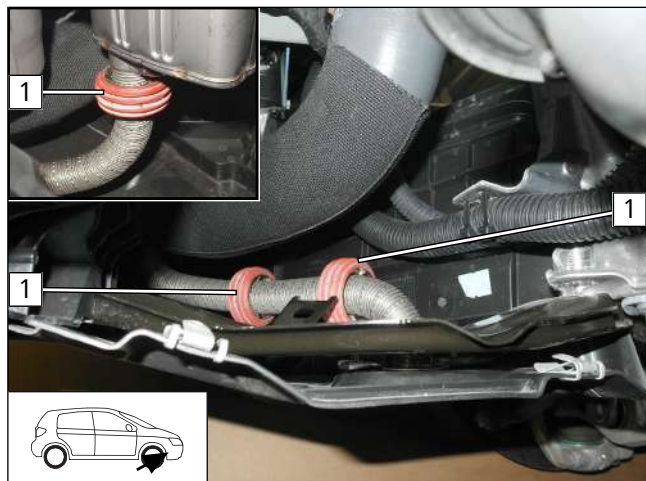

1 ASH

Fig. 92



14 Electrical system of passenger compartment

14.1 Installation instructions for passenger compartment

Removing trim on front passenger's side

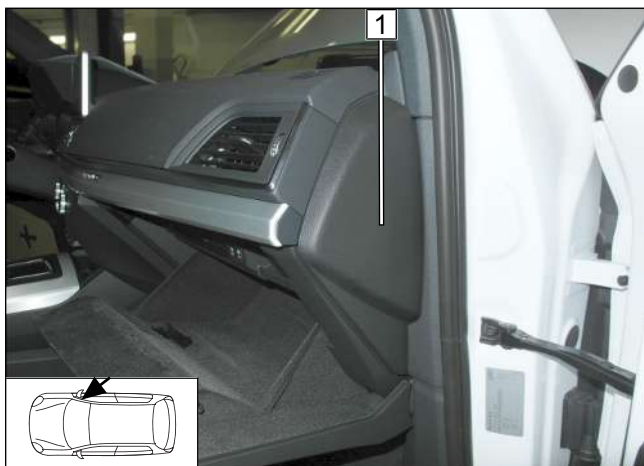

Fig. 93

1 Trim (attached with clips)

Removing trim strip

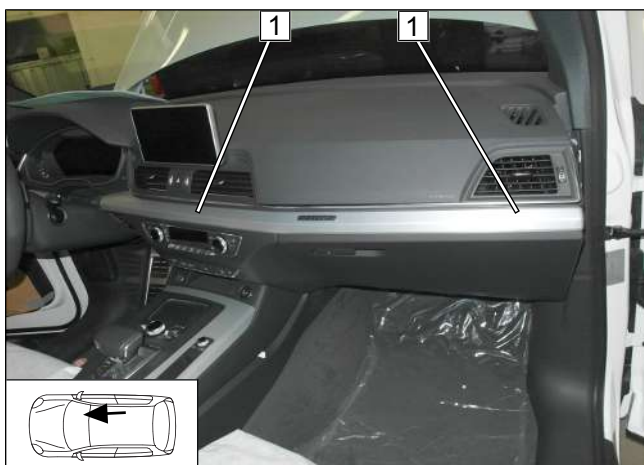

Fig. 94

1 Trim strip (attached with clips)

Loosening screw

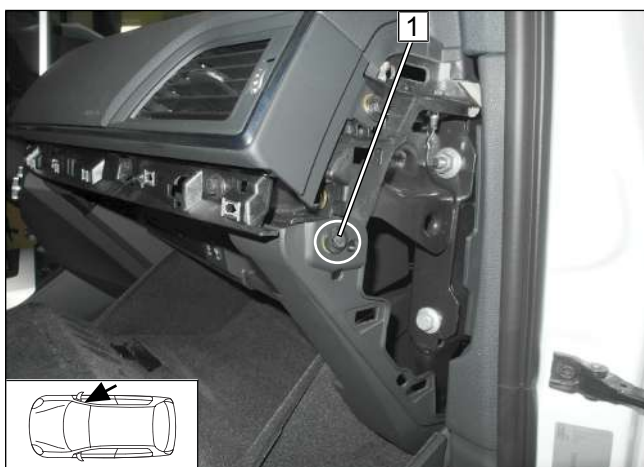

Fig. 95

1 Original vehicle bolt



Detaching multimedia device

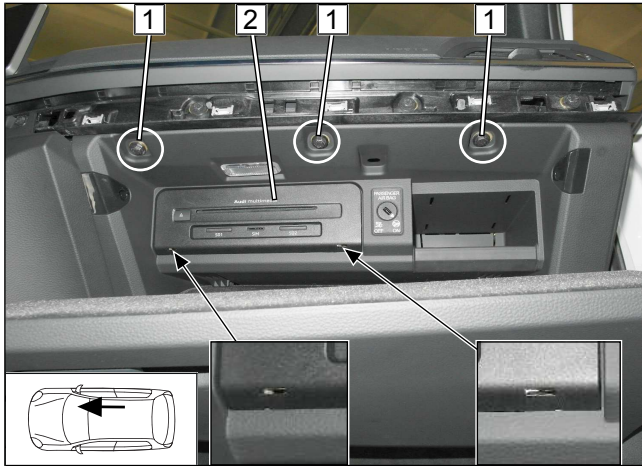

Fig. 96

► Release multimedia device **2** with release tool and pull it out.

1 Loosen original vehicle bolts

Removing glove compartment

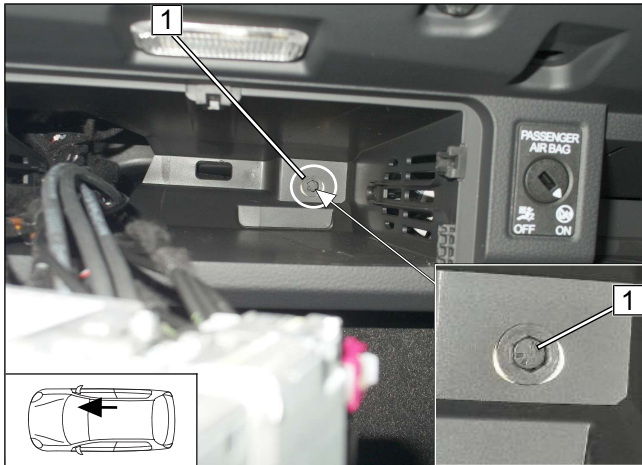

Fig. 97

► Loosen original vehicle bolt **1** and remove glove compartment.

Detaching control panel

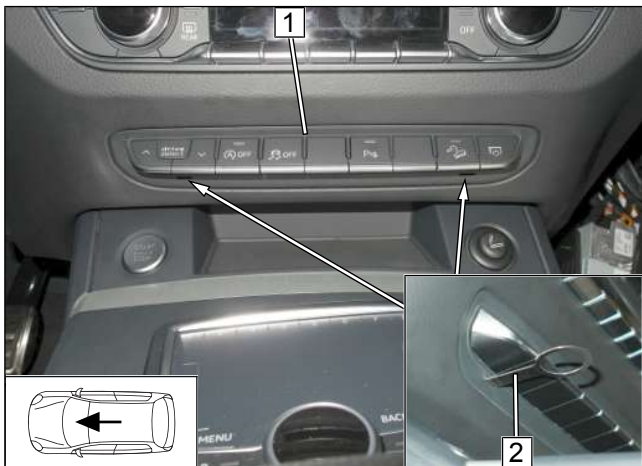

Fig. 98

► Detach control panel **1** using release tool **2** as shown and pull it out.



Detaching trim

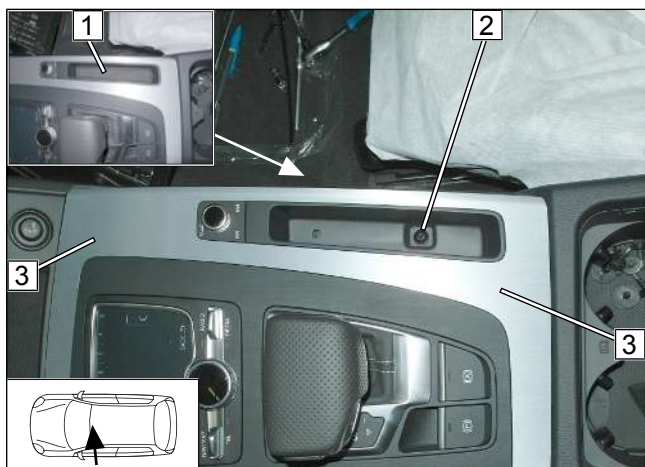

Fig. 99

- 1 Remove rubber insert
- 2 Loosen screw
- 3 Detach trim (attached with clips)

Detaching frame

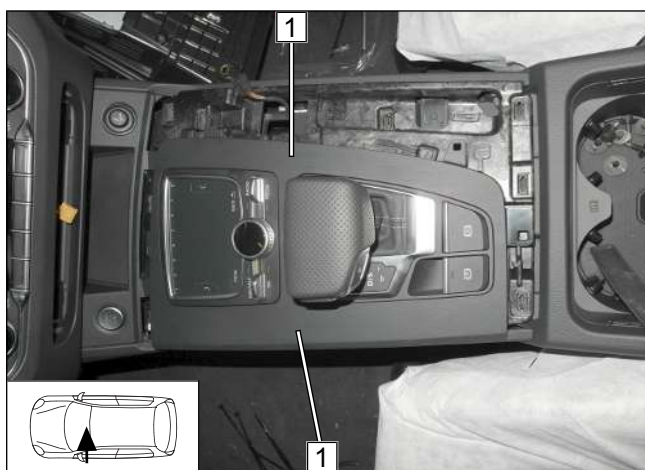

Fig. 100

- 1 Detach frame (attached with clips)

Detaching storage compartment

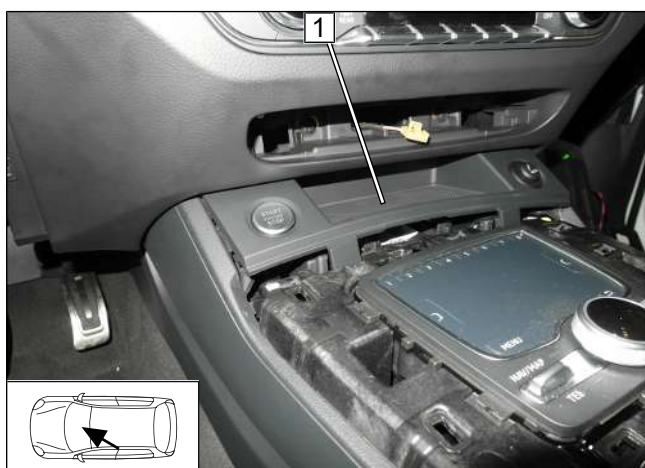
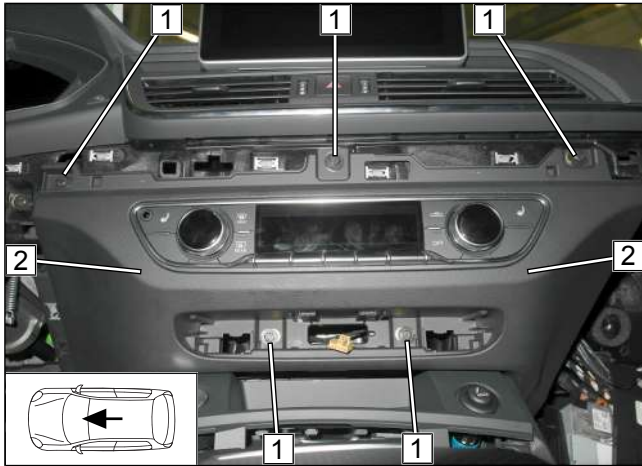

Fig. 101

- Detach storage compartment **1** by pulling it upwards, do not remove.



Removing A/C control panel with frame



- 1 Loosen screws [5x]
- 2 A/C control panel with frame

Fig. 102

14.2 Electrical System Preparation

Assigning wires

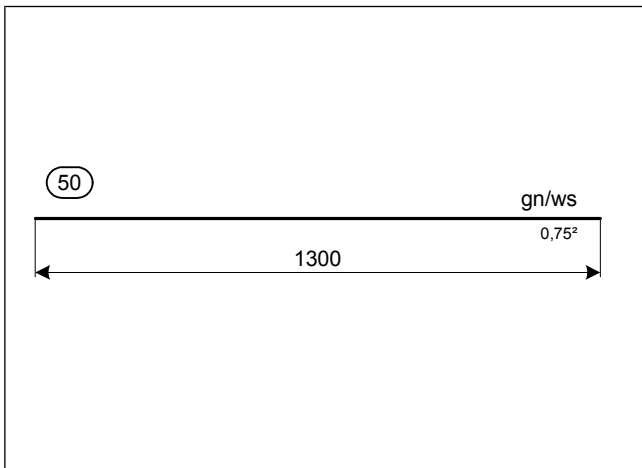

Fig. 103



Wire sections retain their numbering in the entire document.

- Draw wire **50** into provided protective sleeving.



Connecting wire 50 to RSH

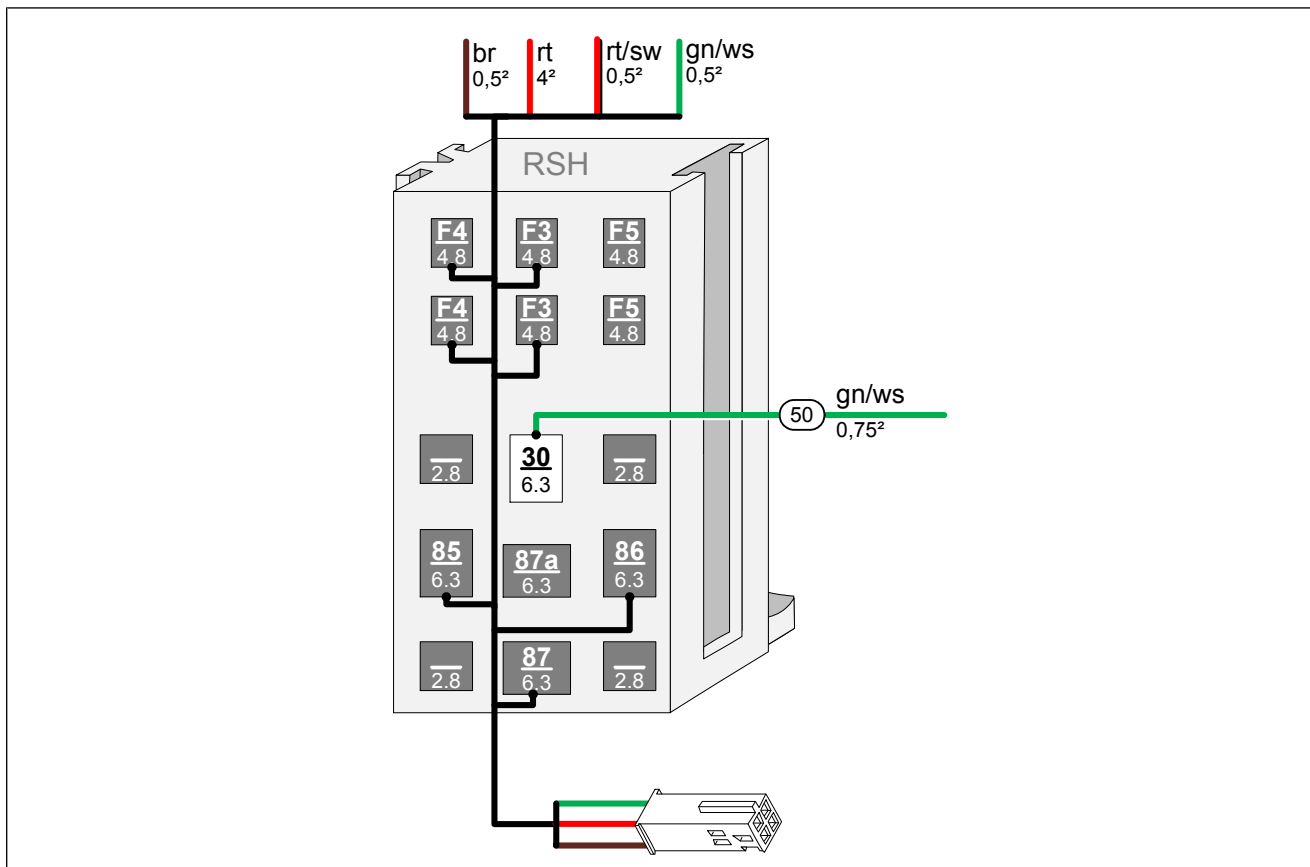
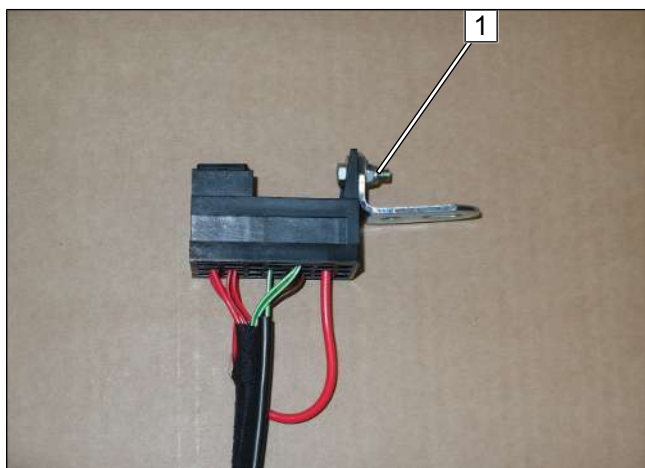

Fig. 104

Installing angle bracket



- 1 M5x16 bolt, large diameter washer, RSH, angle bracket, large diameter washer, nut

Fig. 105



14.3 Wiring diagram

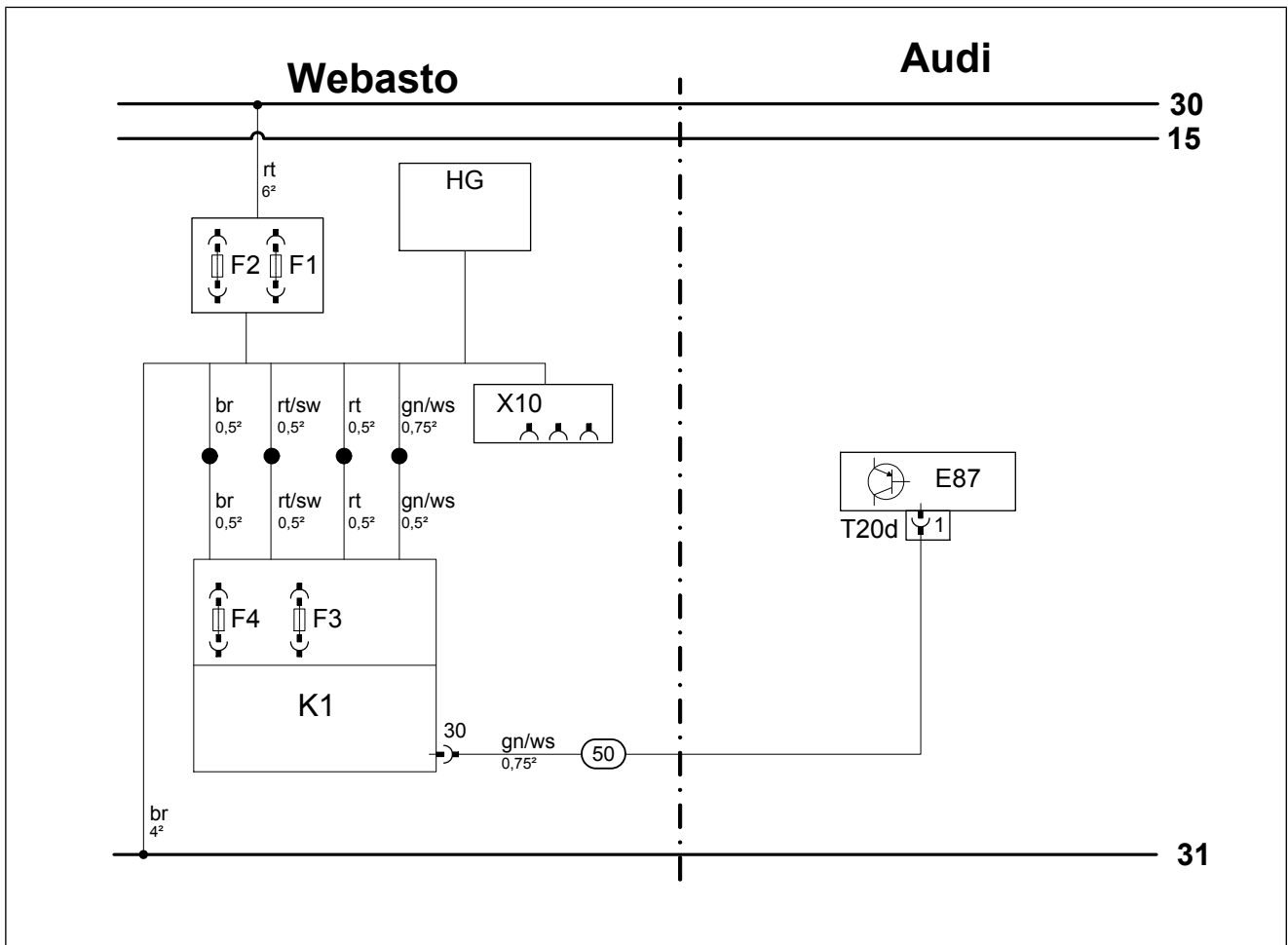

Fig. 106



Legend to wiring diagram

| Vehicle components | | Symbols | |
|--------------------|----------------------|--------------|-------------|
| Abbreviation | Component | Abbreviation | Explanation |
| E87 | A/C control panel | | |
| T20d | 30-pin connector E87 | | |

| Webasto components | | Cable colours | |
|--------------------|--|---------------|-------------|
| Abbreviation | Component | Abbreviation | Colour |
| A | Connector of CLR module wiring harness | br | brown |
| B | Socket of CLR module wiring harness | bg | beige |
| CCL GW | CAN CAN LIN Gateway | dbl | dark blue |
| CL GW | CAN LIN Gateway | dgn | dark green |
| CLR | Cold start module | ge | yellow |
| D1 | Diode | gn | green |
| D2 | Diode group | gr | grey |
| F0 | Additional fuse for power supply | hbl | light blue |
| F1 | Heater main fuse | hgn | light green |
| F2 | Passenger compartment fan controller main fuse | or | orange |
| F3 | Heater control fuse | pk | pink |
| F4 | Fan controller fuse | rt | red |
| F5 | Additional fuse | sw | black |
| HG | Heater TT-Evo | vi | violet |
| K1 | Relay K1 | ws | white |
| K2 | Relay K2 | | |
| K3 | Relay K3 | | |
| LIN GW | LIN Gateway | | |
| PWM GW | Pulse width modulator gateway | | |
| RSH | Relay and fuse holder of passenger compartment | | |
| RTD | Temperature sensor | | |
| X10 | 4-pin socket of heater control | | |



14.4 Fan controller

Mounting relay and fuse holder of passenger compartment

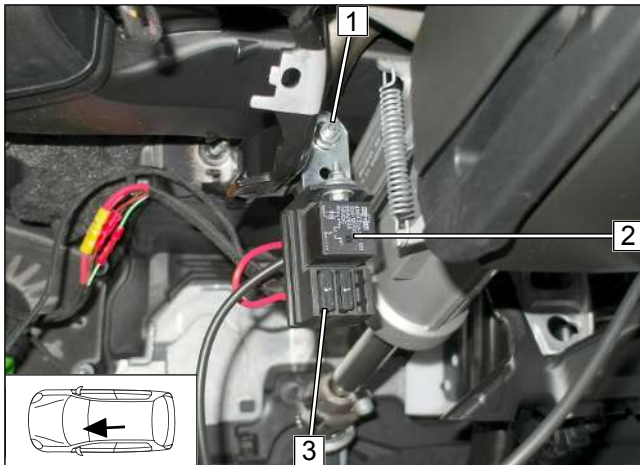

Fig. 107



Produce all following electrical connections as shown in the system wiring diagram.

► Route wire **50** to A/C control panel.

- 1 M6x20 bolt, large diameter washer, original vehicle hole, flanged nut
- 2 Relay K1
- 3 1A fuse F4

Connecting same colour wires of wiring harnesses

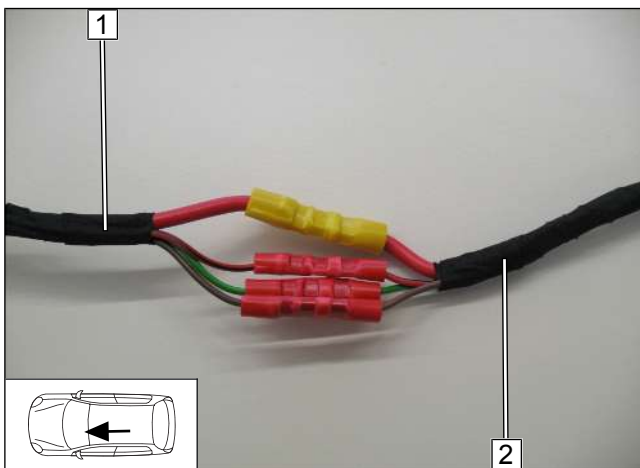

Fig. 108

- 1 Wiring harness of passenger compartment relay and fuse holder
- 2 Heater wiring harness

Mounting socket contact

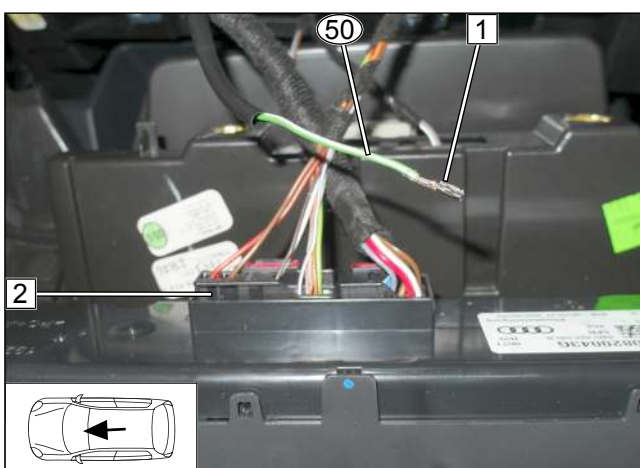
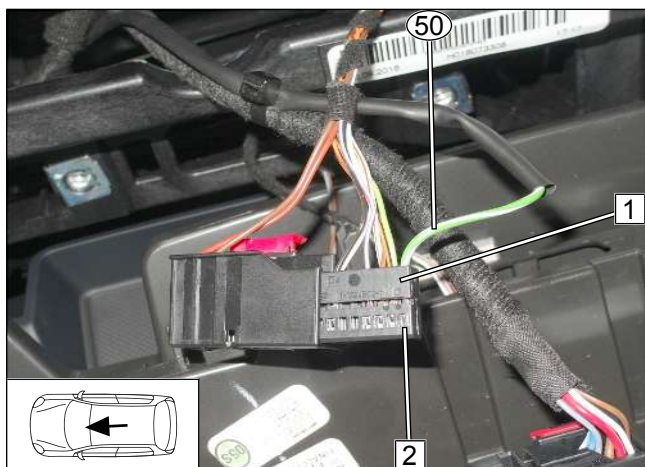

Fig. 109

- 1 Socket contact
- 2 Connector T20d



Connection to A/C control panel



- 1 20-pin connector T20d of A/C control panel
- 2 Slot 1, connector T20d

Fig. 110



15 Electrical system of control element

15.1 MultiControl CAR option

Mounting MultiControl CAR



Fig. 111



Observe the MultiControl CAR installation documentation.

15.2 Telestart option

Mounting receiver

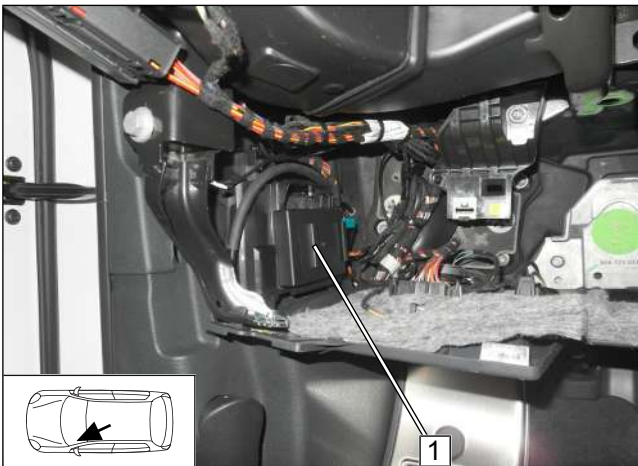

Fig. 112



Observe the Telestart installation documentation.

► Fasten receiver **1** using double-sided adhesive tape.

Mounting temperature sensor, only in case of T100 HTM

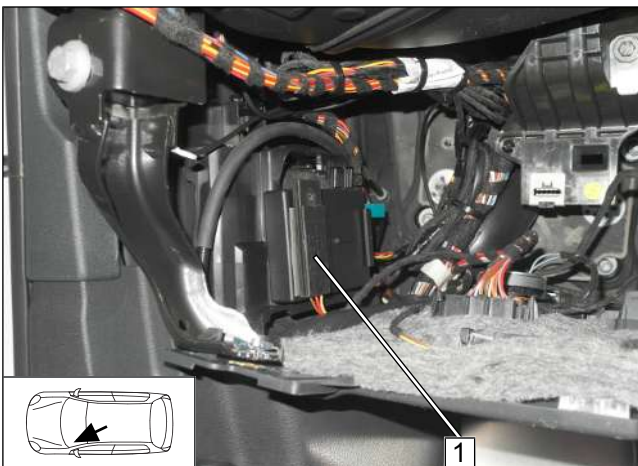

Fig. 113

► Fasten temperature sensor **1** using double-sided adhesive tape.



Installing aerial

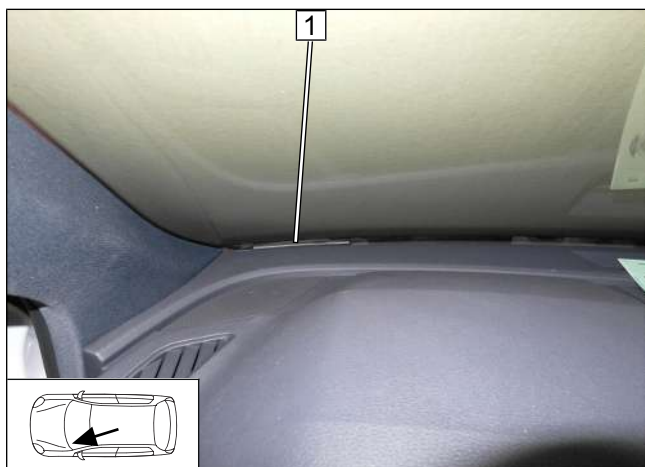

Fig. 114

1 Aerial

15.3 ThermoCall option

Mounting receiver

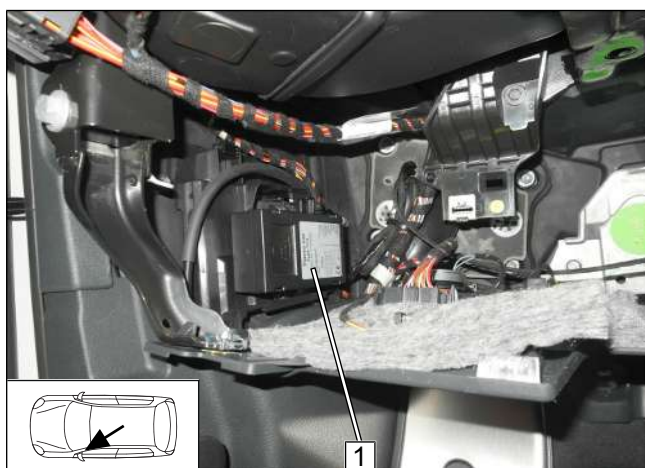

Fig. 115



Observe the ThermoCall installation documentation.

► Fasten receiver 1 using double-sided adhesive tape.

Mounting aerial (optional)

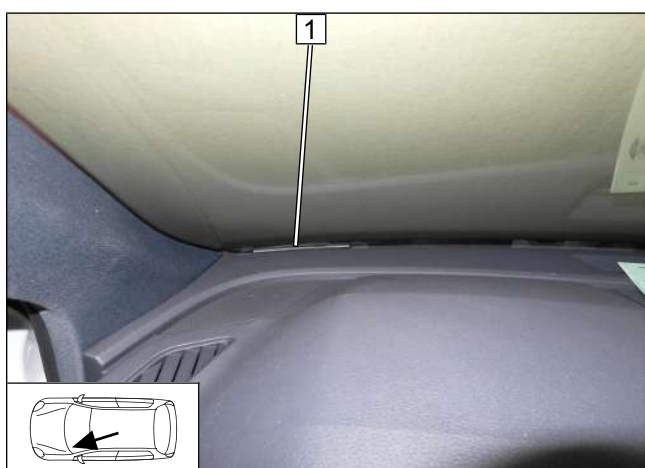

Fig. 116

1 Aerial



16 Final Work



Further information can be found in the vehicle manufacturer's technical documentation.

- ▶ Mount removed parts in reverse order.



- ▶ Check all hoses, clamps and all electrical connections for firm seating.
- ▶ Insulate and tie back loose lines
- ▶ Spray heater and electrical components with anti-corrosion wax (Tectyl 100K).
- ▶ Connect the battery.



Only use manufacturer-approved coolant.

- ▶ Fill and bleed the coolant circuit according to the vehicle manufacturer's specifications.



Further information can be found in the general installation and operating instructions of the Webasto components.

- ▶ Program MultiControl CAR, teach Telestart transmitter
- ▶ Make settings on A/C control panel according to the 'Operating Instructions'.
- ▶ Initial operation and functional test
- ▶ Affix 'Switch off parking heater before refueling' caution label in area of filler neck

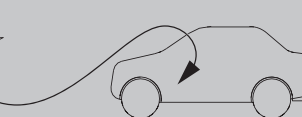
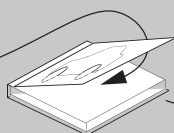
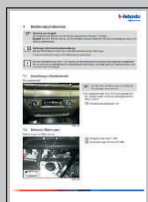
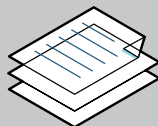

Vehicle-specific work



Further information can be found in the operating instructions of the vehicle manufacturer's diagnosis software.

- ▶ Adjust the Climatronic J255 control unit by enabling 'activate retrofit parking heater without CAN' using a suitable diagnosis tool



These are the original instructions. The German language is binding.
You can request your language if it is missing. The telephone number of each country can be found in the Webasto service centre leaflet or the website of the respective Webasto representative of your country.

Webasto Thermo & Comfort SE
Postfach 1410
82199 Gilching
Germany

Company address:
Friedrichshafener Str. 9
82205 Gilching
Germany

Technical Extranet: <https://dealers.webasto.com>

Only within Germany
Tel: 0395 5592 444
E-mail: technikcenter@webasto.com



WWW.WEBASTO.COM

17 Operating instructions for 1-zone automatic air-conditioning



Information regarding the heating time:

We recommend matching the heating time to the driving time (heating time = driving time)

Example: for a driving time of approx. 20 min. (in one direction), we recommend not exceeding a switch-on time of 20 min.



Vehicles with passenger compartment monitoring:

Further information can be found in the vehicle operating instructions.

- ▶ Deactivate passenger compartment monitoring for the heating operation



All comfort systems are switched off by means of the battery management system in case of an on-board voltage lower than 11.5V. This applies also to the A/C control panel. The parking heater continues to heat, but there is no heat flowing into the passenger compartment of the vehicle.

17.1 A/C control panel settings

1-zone automatic air-conditioning control panel

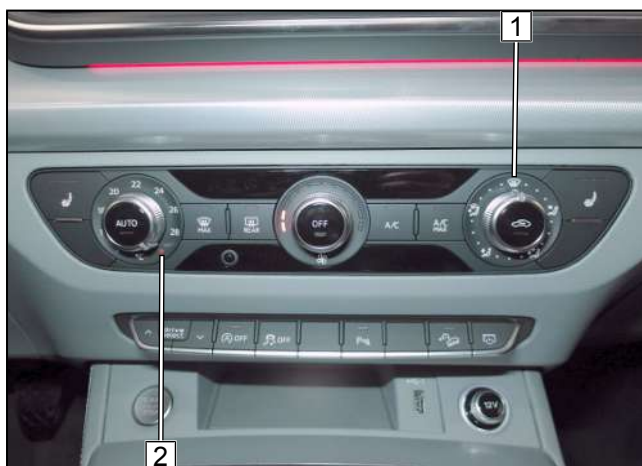

Fig. 117



Before parking the vehicle, make the following settings:

- ▶ The fan speed must not be preset. The fan is set between speed level 1 and 3 depending on the temperature.
- 1 Air outlet to windscreen
- 2 Set temperature to 'max.'

17.2 Installation location of fuses

Fuses in engine compartment

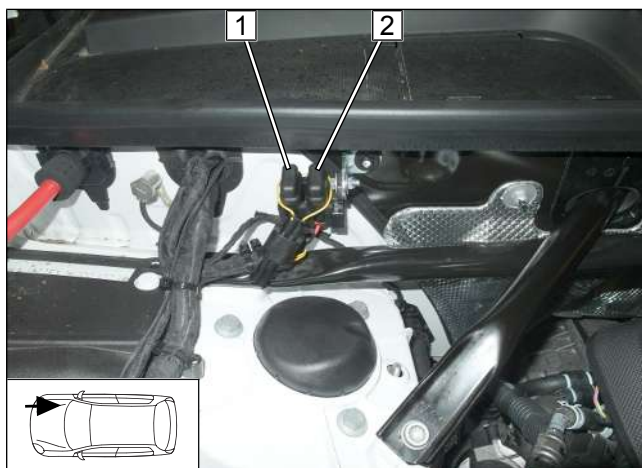
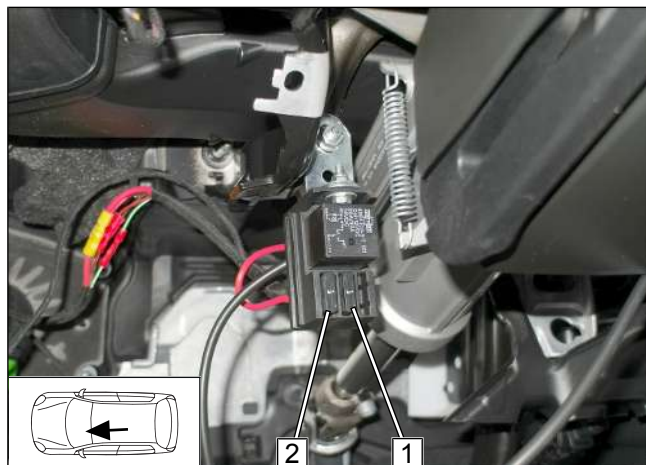

Fig. 118

- 1 F1 - 20A heater fuse (yellow)
- 2 F2 - 30A passenger compartment main fuse (light green)

Fuses in passenger compartment



- 1** F3 - 1A control element fuse (black)
- 2** F4 - 1A fan controller fuse (black)

Fig. 119

18 Operating instructions for 3-zone automatic air-conditioning



Information regarding the heating time:

We recommend matching the heating time to the driving time (heating time = driving time)

Example: for a driving time of approx. 20 min. (in one direction), we recommend not exceeding a switch-on time of 20 min.



Vehicles with passenger compartment monitoring:

Further information can be found in the vehicle operating instructions.

- ▶ Deactivate passenger compartment monitoring for the heating operation



All comfort systems are switched off by means of the battery management system in case of an on-board voltage lower than 11.5V. This applies also to the A/C control panel. The parking heater continues to heat, but there is no heat flowing into the passenger compartment of the vehicle.

18.1 A/C control panel settings

3-zone automatic air-conditioning control panel

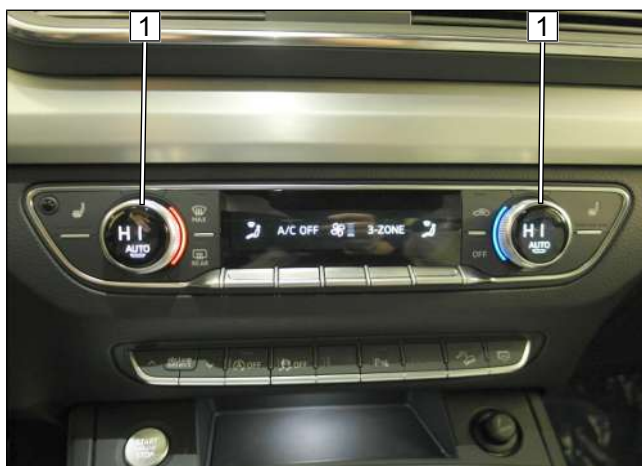

Fig. 120



Before parking the vehicle, make the following settings:

- ▶ The fan speed must not be preset. The fan is set between level 1 and 3 depending on the temperature.

- 1 Temperature on both sides to 'HI'

18.2 Installation location of fuses

Fuses in engine compartment

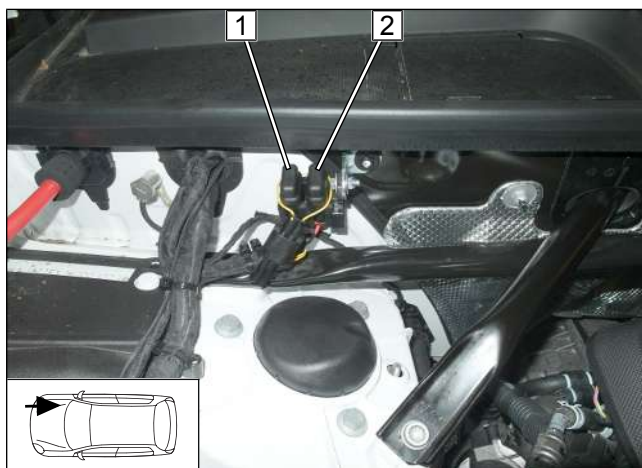
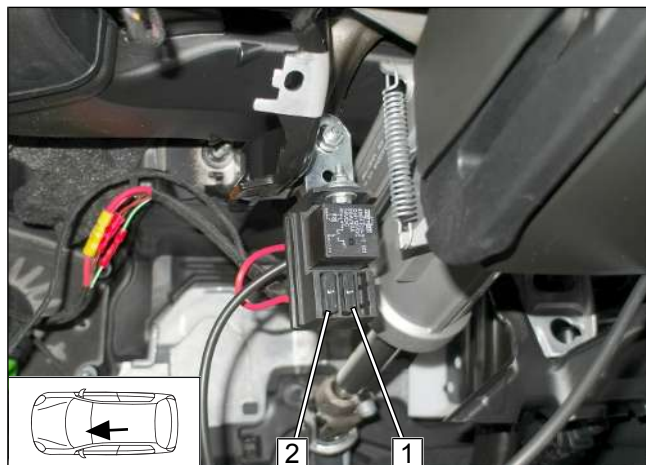

Fig. 121

- 1 F1 - 20A heater fuse (yellow)
- 2 F2 - 30A passenger compartment main fuse (light green)

Fuses in passenger compartment



- 1** F3 - 1A control element fuse (black)
- 2** F4 - 1A fan controller fuse (black)

Fig. 122