



# Water Heater

Thermo Top Evo Parking Heater



## Installation Documentation Citroen C3

### Validity

Manufacturer	Model	Type	Model year	EG BE No. / ABE
Citroen	C3	S	From model year 2017	e2 * 2007 / 46 * 0003 * ...

Motorisation	Fuel	Emission standard	Transmission type	Output in kW	Displacement in cm <sup>3</sup>	Engine code
1.2 P	Petrol	Euro 6	5-speed SG	50	1199	HM01
1.2 P	Petrol	Euro 6	5-speed SG	60	1199	HM01

SG = manual transmission

### Left-hand drive vehicle

**Verified equipment variants:** Manual air-conditioning  
Automatic air-conditioning  
Halogen main headlights  
Halogen front fog lights  
LED daytime running lights  
Keyless system

**Total installation time:** approx. 10.5 hours

# Citroen C3

## Table of Contents

Validity	1	Preparing Installation Location	22
Necessary Components	2	Preparing Heater	23
Installation Instructions	2	Installing Heater	25
Information on Total Installation Time	2	Coolant Circuit	26
Information on Operating and Installation Instructions	3	Exhaust Gas	30
Information on Validity	4	Exhaust End Fastener Installation	31
Technical Information	4	Combustion Air	33
Explanatory Notes on Document	4	Fuel	34
Preliminary Work	5	Installing FuelFix	36
Heater Installation Location	5	Final Work	40
Preparing Electrical System	6	Template for Bracket A	42
Electrical System	12	Template for Bracket B	43
Dismantling Instructions for the Passenger Compartment	13	Installation Location Template	44
Manual Air-Conditioning Fan Controller	15	FuelFix Template	45
Automatic Air-Conditioning Fan Controller	17	Operating Instructions for Manual Air-Conditioning	46
Heater Control Installation	20	Operating Instructions for Automatic A/C	47
Remote Option (Telestart)	20		
ThermoCall Option	21		

## Necessary Components

Description	Order No.:
Basic delivery scope of Thermo Top Evo	In accordance with price list
Installation kit for Citroen C3 1.2 Petrol 50/60kW MY 2017	1325836A
Additional automatic A/C kit for Citroen C3 1.2 Petrol MY 2017	1325859A
Heater control as well as indicator lamp for Telestart in consultation with end customer	In accordance with price list

## Individual Webasto Option

Description	Order No.:
Additional kit individual Webasto auxiliary heating	1320077_
Additional kit individual Webasto Quick	9030826_
Additional kit individual Webasto Select	9030828_

## Installation Instructions

Arrange for the vehicle to be delivered with the tank only about ¼ full.

The installation location of the push button in case of Telestart or ThermoCall should be confirmed with the end customer.

Depending on the space required and the vehicle manufacturer's instructions, we recommend the use of a vehicle battery with a higher electrical capacity.

## Information on Total Installation Time

The total installation time includes the time needed for mounting and demounting the vehicle-specific components, the heater specific installation time and all other times required for the system integration and initial start-up of the heater.

The total installation time may vary for vehicle equipment other than provided.

## Information on Operating and Installation Instructions

### 1 Important information (not complete)

#### 1.1 Installation and repair



The improper installation or repair of Webasto heating and cooling systems can cause fire or the leakage of deadly carbon monoxide, leading to serious injury or death.



To install and repair Webasto heating and cooling systems you need to have completed a special company training course and have the appropriate technical documentation, special tools and special equipment.



Installation and repair may ONLY be carried out by persons trained and certified in a Webasto training course. NEVER try to install or repair Webasto heating or cooling systems if you have not completed a Webasto training course, you do not have the necessary technical skills and you do not have the technical documentation, tools and equipment available to ensure that you can complete the installation and repair work properly.

Only use genuine Webasto parts. See the Webasto air and water heaters accessories catalogue for this purpose.

#### 1.2 Operation

To ensure safe operation, we recommend having the heater checked every two years by an authorised Webasto dealer, especially when used over a long period and/or under extreme environmental conditions.

Do not operate the heater in closed rooms due to the danger of poisoning and suffocation.

Always switch off the heater before refuelling.

The heater may only be used with the prescribed fuel diesel (DIN EN 590) or petrol (DIN EN 228).

The heater may not be cleaned with a high-pressure cleaner.

#### 1.3 Please note

ALWAYS follow all Webasto installation and operating instructions and observe all warnings.

To become familiar with and understand all functions and properties of the heater, the operating instructions must be read carefully and observed at all times.

For proper, safe installation and repair work, the installation instructions with all warnings and safety information must be carefully read and observed at all times. Please always contact a workshop authorised by Webasto for all installation and repair work.

#### Important

**Webasto shall assume no liability for defects, damage and injuries resulting from a failure to observe the installation, repair and operating instructions of the information contained in them.**

**This liability exclusion particularly applies to improper installations and repairs, installations and repairs by untrained persons or in the case of a failure to use genuine spare parts.**

**The liability due to culpable disregard to life, limb or health and due to damage or injuries caused by a wilful or reckless breach of duty remain unaffected, as does the obligatory product liability.**

Installation should be carried out according to the general, standard rules of technology. Unless specified otherwise, fasten hoses, lines and wiring harnesses to original vehicle lines and wiring harnesses using cable ties. Insulate loose wire ends and tie back. Connectors on electronic components must audibly snap into place during assembly.

Sharp edges should be fitted with rub protection. Spray unfinished body areas, e.g. drilled holes, with anti-corrosion wax (Tectyl 100K).

Observe the instructions and guidelines of the respective vehicle manufacturer for demounting and mounting vehicle specific components!

The initial start-up is to be executed with the Webasto Thermo Test Diagnosis.

When installing a programmable control module (e.g. a PWM Gateway), the corresponding settings must be checked or adjusted.

### 2 Statutory regulations governing installation

Guidelines	Thermo Top Evo
Heating Directive ECE R122	E1 00 0258
EMC Directive ECE R10	E1 04 5627

#### Note

The regulations of these guidelines are binding in the scope of the Directive 70/156/EEC and/or 2007/46/EC (for new vehicle models from 29/04/2009) and should also be observed in countries in which there are no special regulations.

#### Important

Failure to follow the installation instructions will result in the invalidation of the type approval for the heater and therefore invalidation of the general **homologation of the vehicle**.

#### Note

The heater is licensed in accordance with paragraph 19, section 3, No. 2b of the StVZO (German Road Traffic Licensing Authority).

### 2.1 Excerpt from ECE regulation 122 (heating system) paragraph 5 for the installation of the heater

Beginning of excerpt.

#### ANNEX VII

#### REQUIREMENTS FOR COMBUSTION HEATERS AND THEIR INSTALLATION

##### 1. GENERAL REQUIREMENTS

1.7.1. A clearly visible tell-tale in the operator's field of view shall inform when the combustion heater is switched on or off.

##### 2. VEHICLE INSTALLATION REQUIREMENTS

###### 2.1. Scope

2.1.1. Subject to paragraph 2.1.2, combustion heaters shall be installed according to the requirements of this Annex.

2.1.2. Vehicles of category O having liquid fuel heaters are deemed to comply with the requirements of this Annex.

###### 2.2. Positioning of heater

2.2.1. Body sections and any other components in the vicinity of the heater must be protected from excessive heat and the possibility of fuel or oil contamination.

2.2.2. The combustion heater shall not constitute a risk of fire, even in the case of overheating. This requirement shall be deemed to be fulfilled if the installation ensures an adequate distance to all parts and suitable ventilation, by the use of fire resistant materials or by the use of heat shields.

2.2.3. In the case of M2 and M3 vehicles, the heater must not be positioned in the passenger compartment. However, an installation in an effectively sealed envelope which also complies with the conditions in paragraph 2.2.2 may be used.

2.2.4. The label referred to in paragraph 1.4 or a duplicate, must be positioned so that it can be easily read when the heater is installed in the vehicle.

2.2.5. Every reasonable precaution should be taken in positioning the heater to minimise the risk of injury and damage to personal property.

###### 2.3. Fuel supply

2.3.1. The fuel filler must not be situated in the passenger compartment and must be provided with an effective cap to prevent fuel spillage.

2.3.2. In the case of liquid fuel heaters, where a supply separate to that of the vehicle is provided, the type of fuel and its filler point must be clearly labelled.

2.3.3. A notice, indicating that the heater must be shut down before refuelling, must be affixed to the fuelling point. In addition a suitable instruction must be included in the manufacturer's operating manual.

###### 2.4. Exhaust system

2.4.1. The exhaust outlet must be located so as to prevent emissions from entering the vehicle through ventilators, heated air inlets or opening windows.

###### 2.5. Combustion air inlet

2.5.1. The air for the combustion chamber of the heater must not be drawn from the passenger compartment of the vehicle.

2.5.2. The air inlet must be so positioned or guarded that blocking by rubbish or luggage is unlikely.

###### 2.6. Heating air inlet

2.6.1. The heating air supply may be fresh or recirculated air and must be drawn from a clean area not likely to be contaminated by exhaust fumes emitted either by the propulsion engine, the combustion heater or any other vehicle source.

2.6.2. The inlet duct must be protected by mesh or other suitable means.

###### 2.7. Heating air outlet

2.7.1. Any ducting used to route the hot air through the vehicle must be so positioned or protected that no injury or damage could be caused if it were to be touched.

2.7.2. The air outlet must be so positioned or guarded that blocking by rubbish or luggage is unlikely.

End of excerpt.

In multilingual versions the German language is binding.

# Citroen C3

## Information on Validity

This installation documentation applies to Citroen C3 Petrol vehicles - for validity, see page 1 - from model year 2017 and later, assuming technical modifications to the vehicle do not affect installation, any liability claims excluded. Depending on the vehicle version and equipment, modifications may be necessary during installation with respect to this 'installation documentation'.

Vehicle and engine types, equipment variants and other specifications not listed in this installation documentation have not been tested. However, installation according to this installation documentation may be possible.

## Technical Information

### Special Tools

- Hose clamp pliers for auto-tightening hose clamps
- Hose clamp pliers for Clic hose clamps of type W
- Automatic wire stripper 0.2 - 6mm<sup>2</sup>
- Crimping pliers for cable lug / tab connector 0.5 - 6mm<sup>2</sup>
- Torque wrench for 2.0 - 10 Nm
- Hose clamping pliers
- Metric thread-setter kit
- Deep-hole marker
- Webasto Thermo Test Diagnosis with current software

### Dimensions

- All dimensions are in mm.

### Tightening torque values

- Tightening torque values of 5x13 heater bolts and 5x11 heater stud bolts = 8Nm.
- Tightening torque value of 5x15 water connection piece retaining plate bolt = 7Nm.
- Tighten other bolt connections in accordance with manufacturer's instructions or in accordance with state-of-the-art technology.

## Explanatory Notes on Document

You will find an identification mark on the outside top right corner of the page in question to provide you with a quick overview of the individual working steps.

### Mechanics



### Electrics



### Coolant Circuit



### Combustion Air

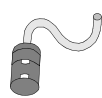

### Fuel



### Exhaust



### Software



Special features are highlighted using the following symbols:

**Specific risk of damage to components.**



**Reference to the manufacturer's vehicle-specific documents.**



**Specific risk due to electrical voltage.**



**Reference to specific installation instructions of Webasto components (shown, for example, FuelFix).**



**Specific risk of fire or explosion.**



**Reference to general installation instructions of Webasto components.**



**Reference to a special technical feature.**



**Tightening torque according to the manufacturer's vehicle-specific documents.**



**The arrow in the vehicle icon indicates the position on the vehicle and the viewing angle.**

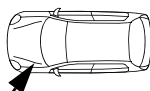

## Preliminary Work

### Vehicle

- Open the fuel tank cap.
- Ventilate the fuel tank.
- Close the fuel tank cap again.
- Depressurise the cooling system.
- Disconnect and completely remove the battery together with the carrier.
- Remove the lower engine cover (if present).
- Remove the underride protection on the left (if present).
- Remove the left front wheel.
- Remove the wheel well trim on the left-hand side, detach it in the right front area.
- Remove the daytime running light above the headlight.
- Unhook the bonnet latch from the locking device.
- Remove the bumper trim.
- Detach the rear bench seat (clipped in).
- Remove the lower instrument panel trim on the driver's side.
- Remove the side trim of the centre console on the right and the left.
- Remove the lateral instrument panel trim on the right and the left.
- Remove the glove box.



### Heater

- Remove years that do not apply from the type and duplicate label.
- Attach the duplicate label (type label) visibly in the appropriate place in the engine compartment.

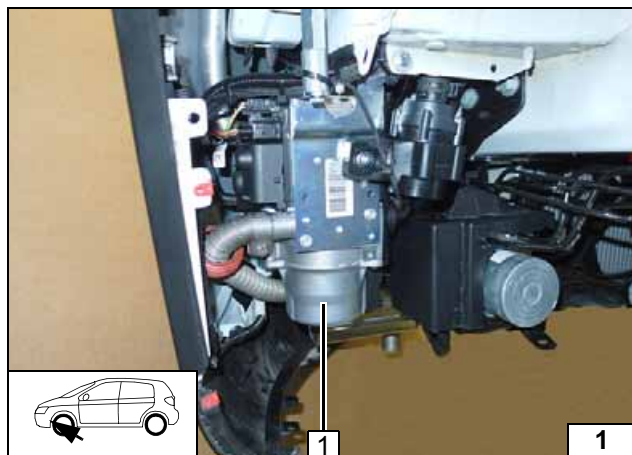

### Heater Installation Location

- 1 Heater

Installation location

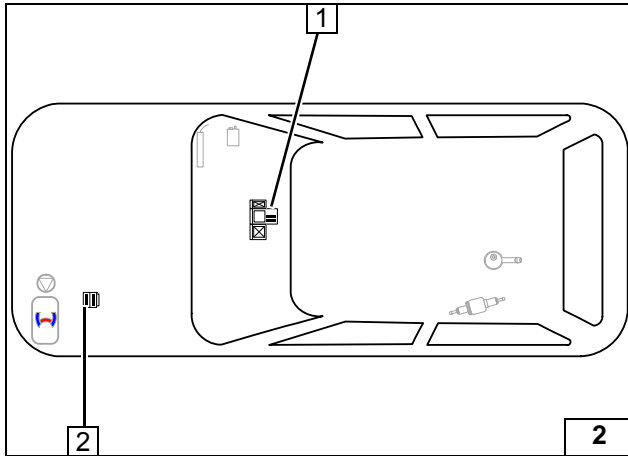
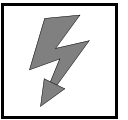

### Preparing Electrical System

- 1 Passenger compartment relay and fuse holder, PWM GW, relay K2 (only in case of automatic A/C)
- 2 Engine compartment fuse holder



### Installation overview

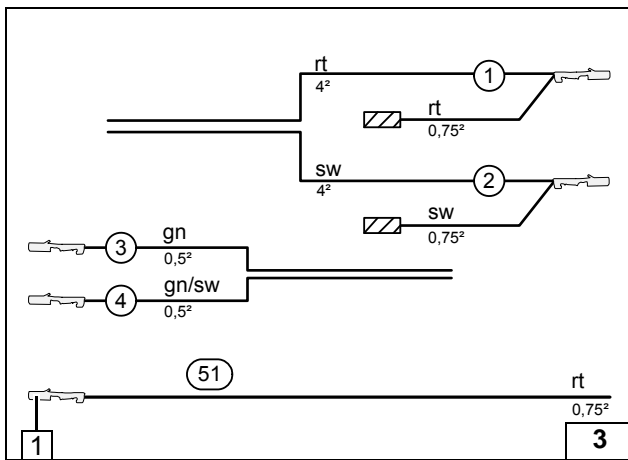

Wire sections retain their numbering in the entire document.

### Manual air-conditioning

Pull wire (51) into provided protective sleeving.

- 1 Blade receptacle
- ① Red (rt) wire of fan wiring harness
- ② Black (sw) wire of fan wiring harness
- ③ Green (gn) wire from wiring harness of PWM control
- ④ Green/black (gn/sw) wire from wiring harness of PWM control



### Preparing / assigning wires

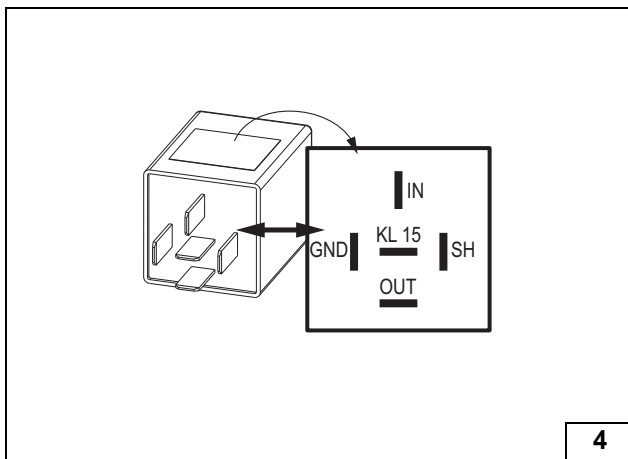

Check the PWM Gateway settings when starting up the heater and adjust if necessary.

Settings:

- Duty cycle: 70%
- Frequency: 400Hz
- Voltage: not relevant
- Function: Low side



### View of PWM GW

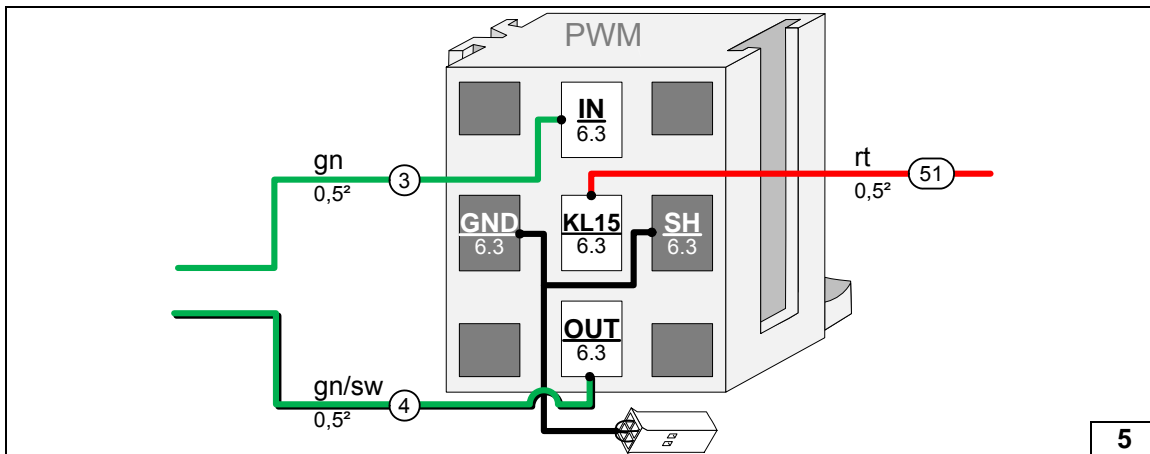

### Connecting wires to PWM GW socket

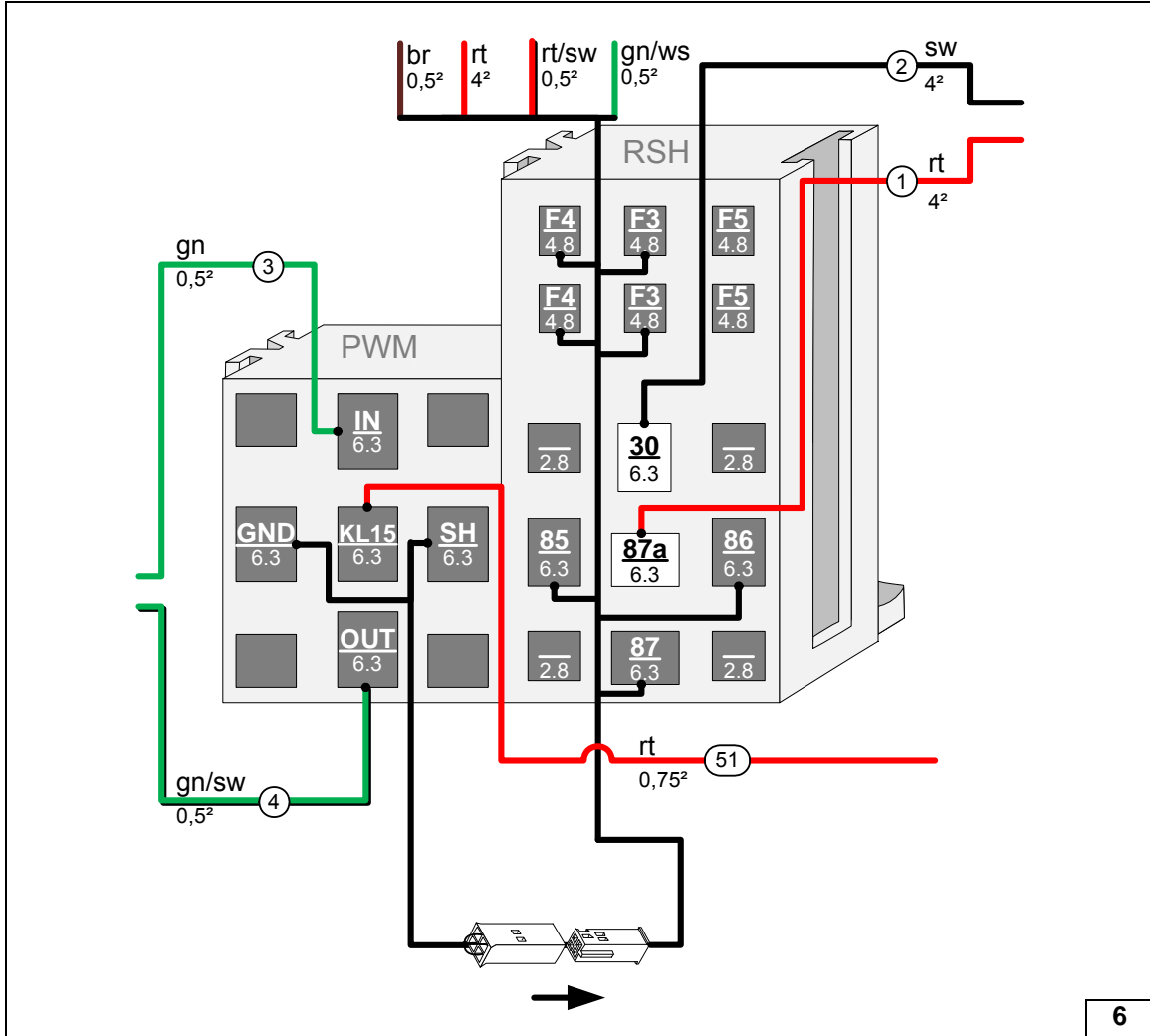
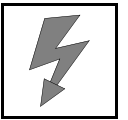

Assembling PWM-GW socket and passenger compartment relay and fuse holder, connecting connector and socket, connecting wires

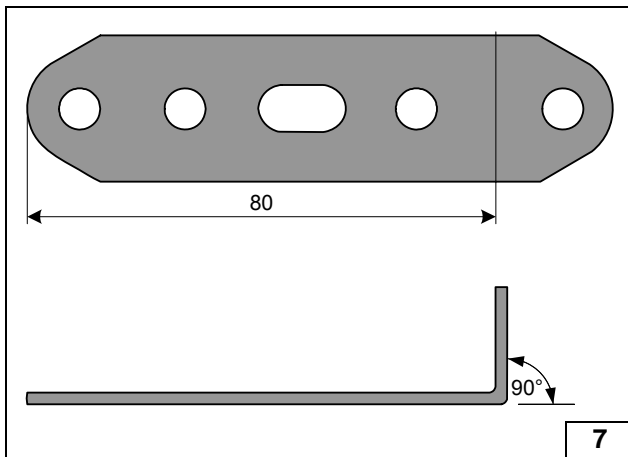

Preparing perforated bracket

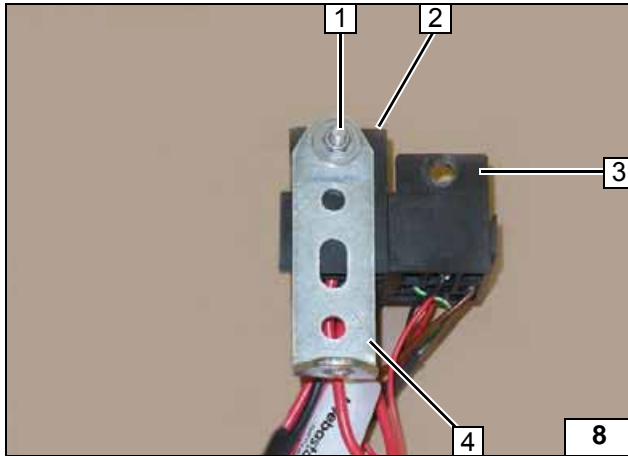
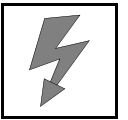

- 1 M5x16 bolt, large diameter washer [2x], nut
- 2 Passenger compartment relay and fuse holder socket
- 3 PWM GW socket
- 4 Perforated bracket

Installing perforated bracket

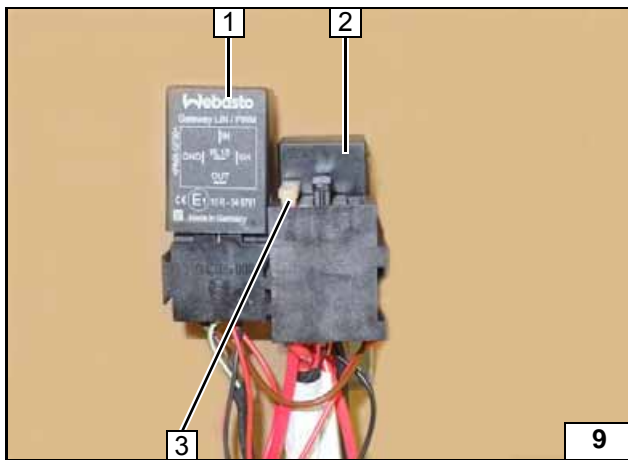

- 1 PWM GW
- 2 Relay K1
- 3 25A fuse F4

Installing relay K1 and PWM GW

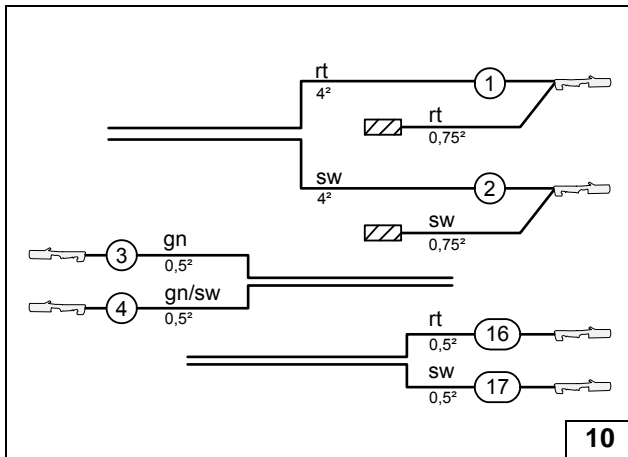

Automatic air-conditioning

- ① Red (rt) wire of fan wiring harness
- ② Black (sw) wire of fan wiring harness
- ③ Green (gn) wire from wiring harness of PWM control
- ④ Green/black (gn/sw) wire from wiring harness of PWM control
- ⑬ Red (rt) wire of isolating relay wiring harness
- ⑭ Black (sw) wire of isolating relay wiring harness

Assigning wires

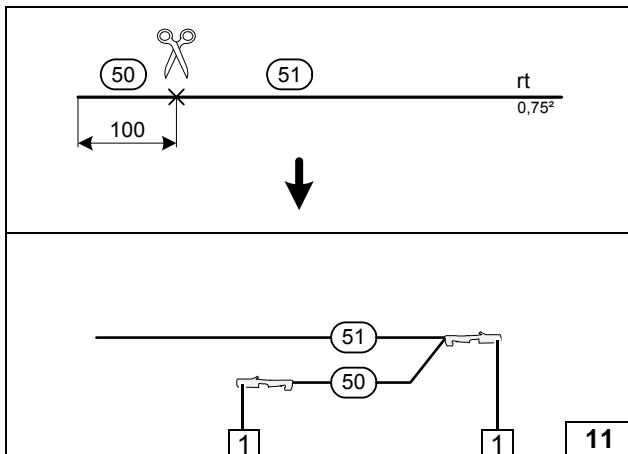

Pull wire (51) into provided protective sleeving.

- 1 Blade receptacle [2x]

Preparing / assigning wires





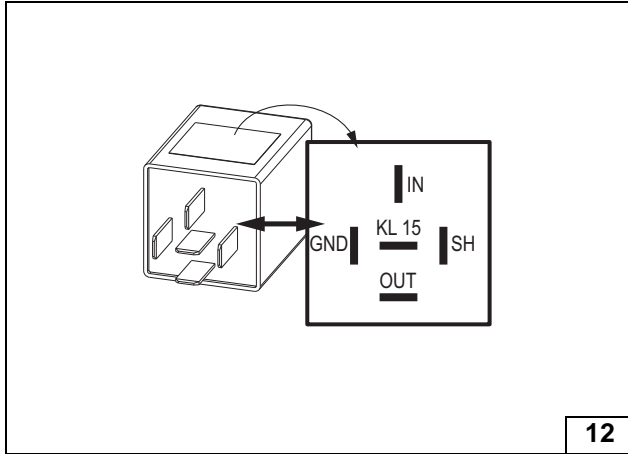

Check the PWM Gateway settings when starting up the heater and adjust if necessary.

Settings:

- Duty cycle: 70%
- Frequency: 400Hz
- Voltage: not relevant
- Function: Low side



View of PWM GW

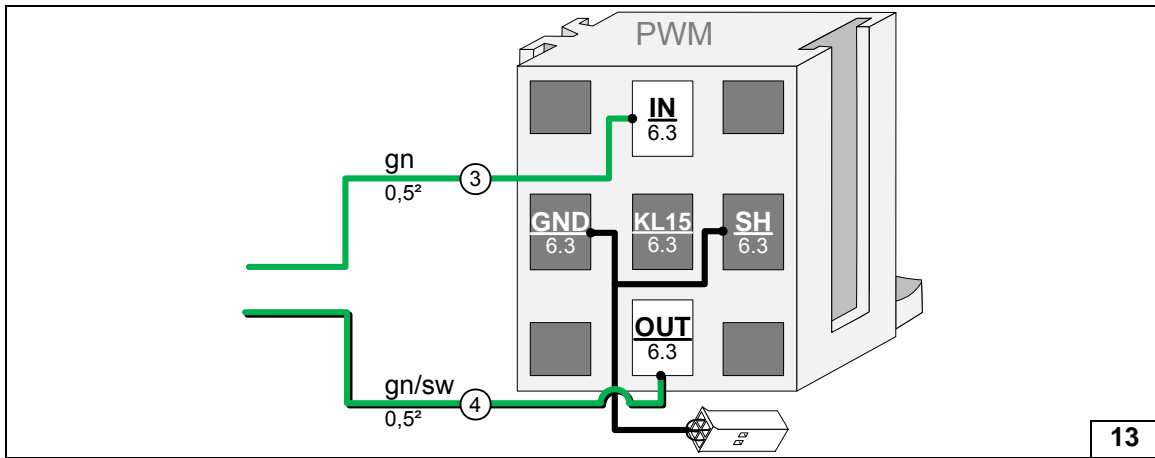

Connecting wires to PWM GW socket

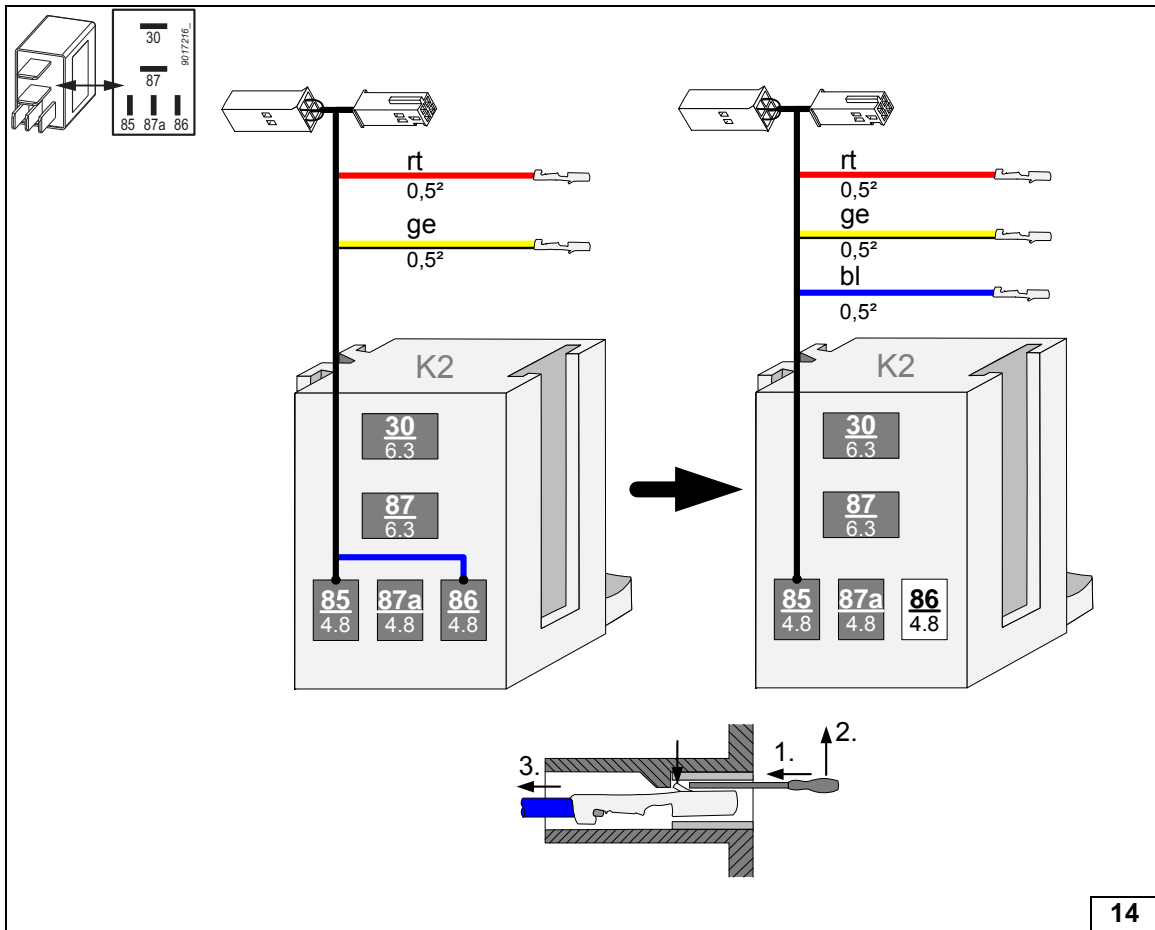

Disconnecting blue (bl) wire from relay K2 socket

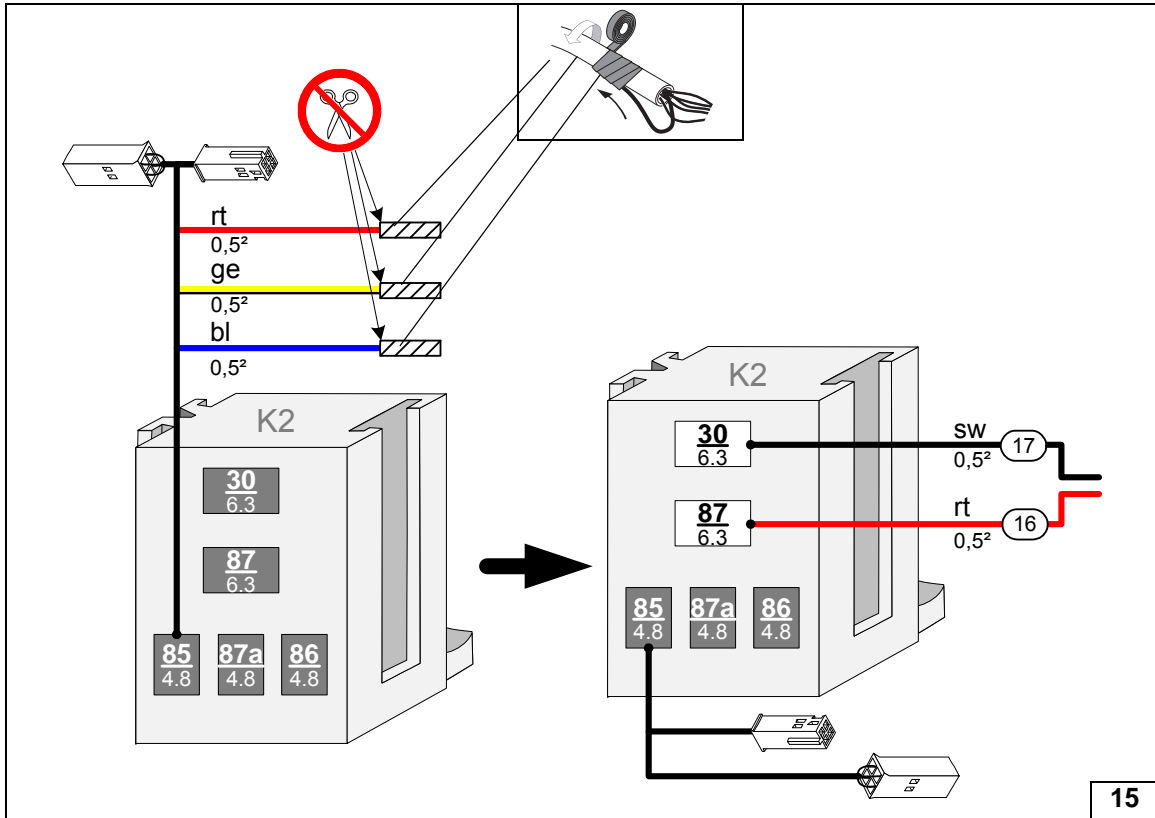
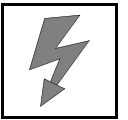

Insulating/  
connecting  
wires of relay K2 sock-  
et

15

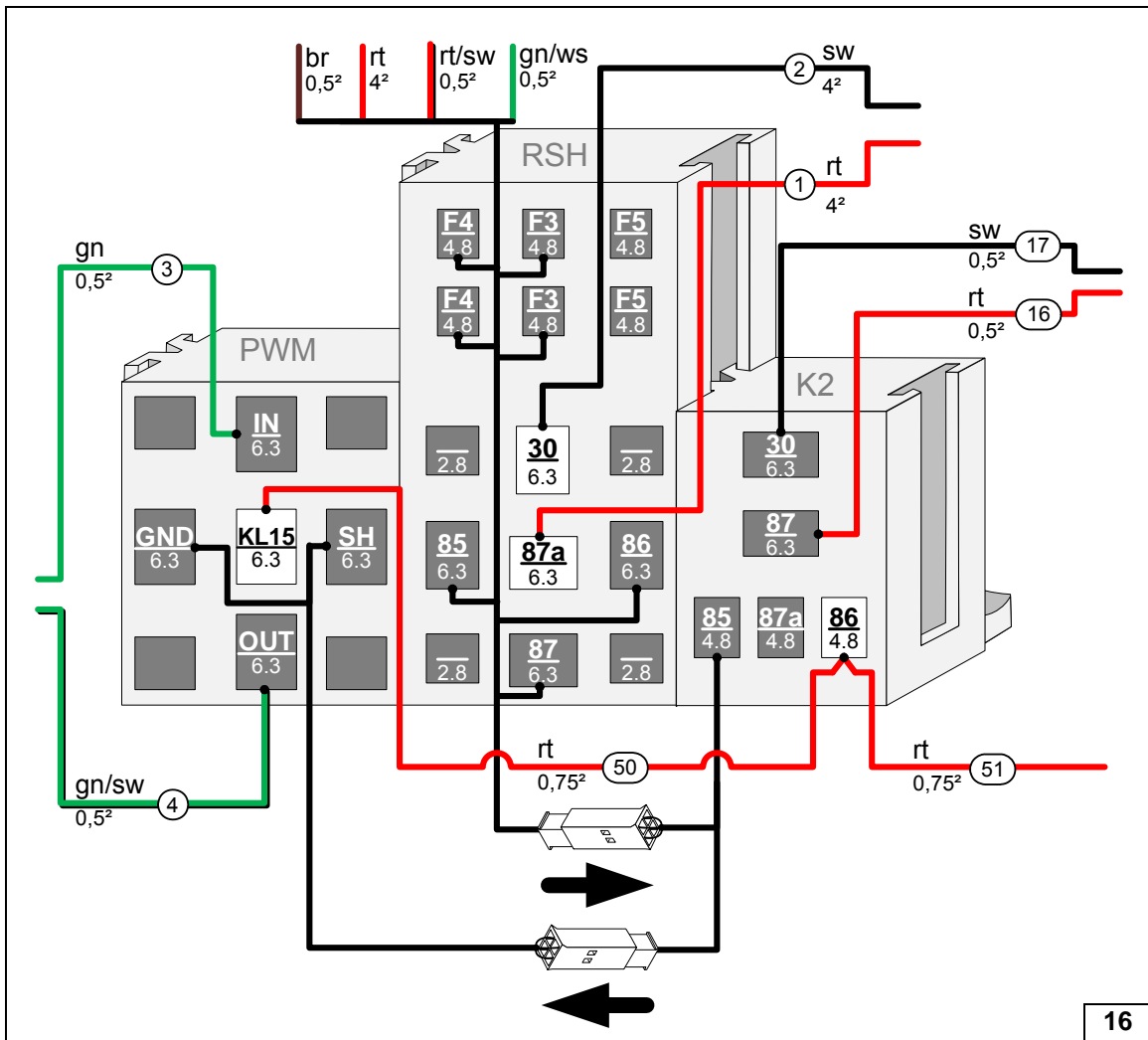

Assembling  
PWM-GW  
socket, relay  
K2 and pas-  
senger com-  
partment  
relay and  
fuse holder,  
connecting  
connector  
and socket,  
connecting  
wires

16

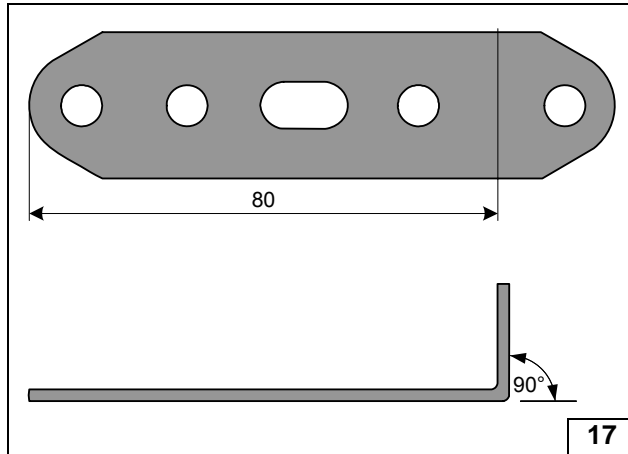
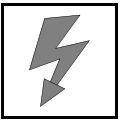

**Preparing perforated bracket**

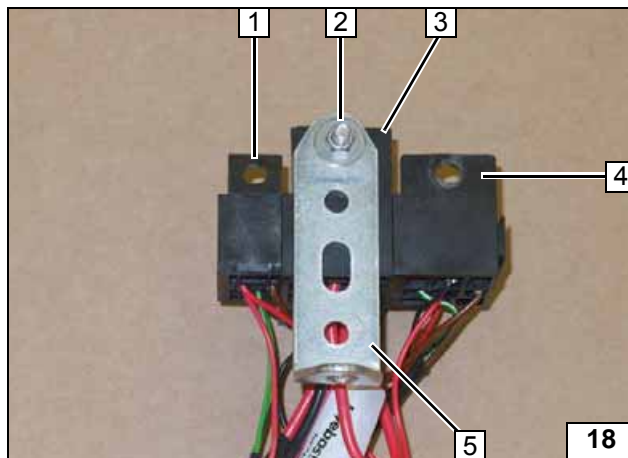

- 1 Relay K2 socket
- 2 M5x16 bolt, large diameter washer [2x], nut
- 3 Passenger compartment relay and fuse holder socket
- 4 PWM GW socket
- 5 Perforated bracket

**Installing perforated bracket**

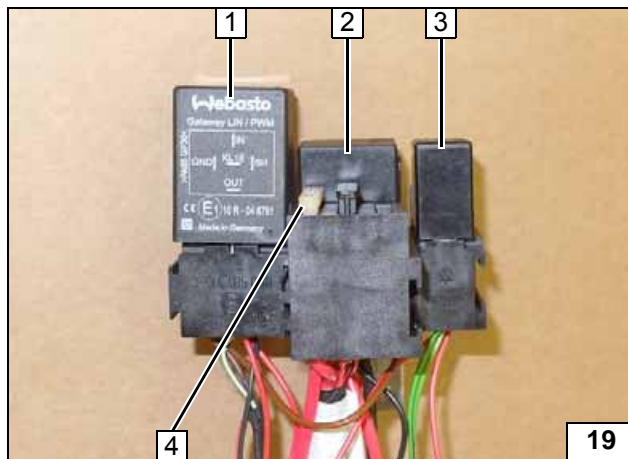

- 1 PWM GW
- 2 Relay K1
- 3 Relay K2
- 4 25A fuse F4

**Installing relay K1, PWM GW and relay K2**

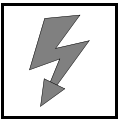

**Electrical System**



**Positive wire**

- 1 Positive wire on original vehicle positive distributor, without control unit 2 on battery
- 3 Positive wire on positive battery terminal, with control unit 2 on battery

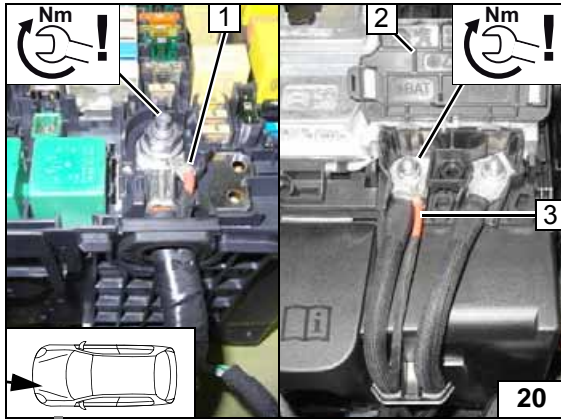

**Wiring harness pass through**

- 1 Protective rubber plug
- 2 Wiring harnesses of heater, heater control

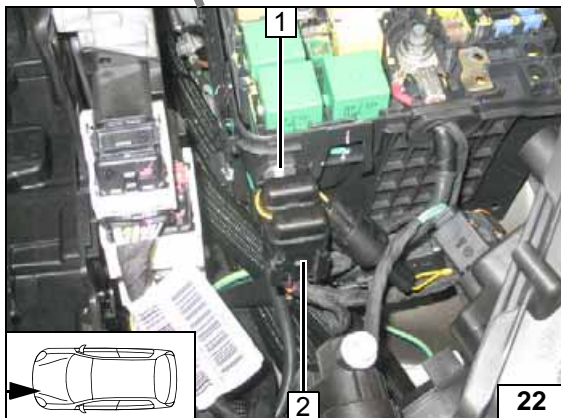
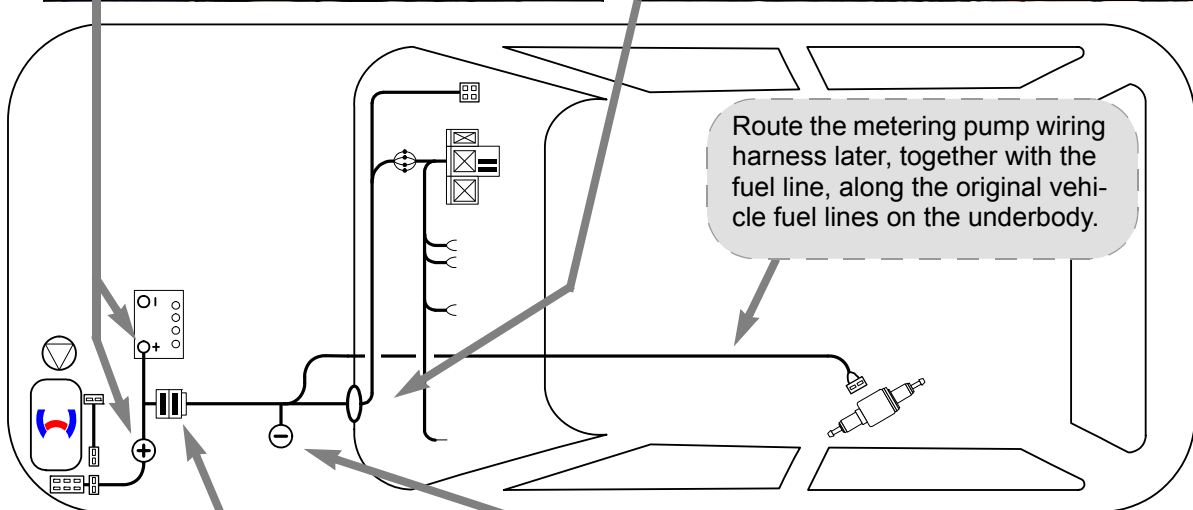
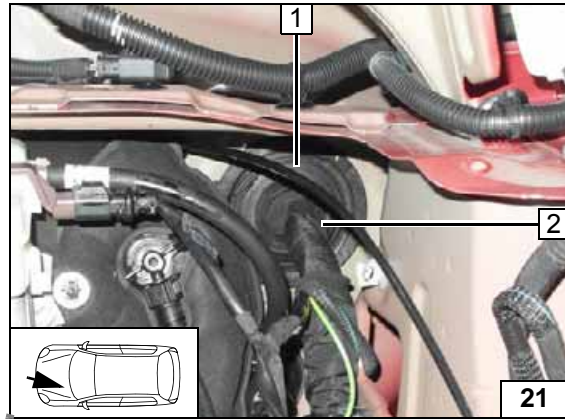

**Engine compartment fuse holder**

5.5 mm dia. hole at position 1. When drilling, be careful of components located behind!

- 1 M5x16 bolt, washer [2x], retaining plate of fuse holder, nut
- 2 Fuses F1-2

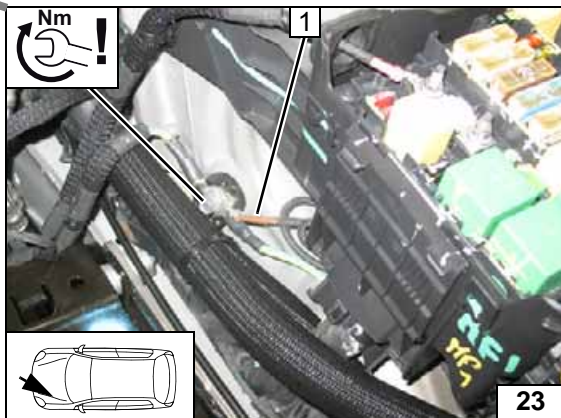

**Earth wire**

- 1 Earth wire on original vehicle earth support point



**Wiring harness routing diagram**



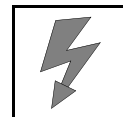

### Dismantling Instructions for the Passenger Compartment

1 Lower instrument panel trim on driver's side

- Fastening clip [6x]

Removing lower instrument panel trim

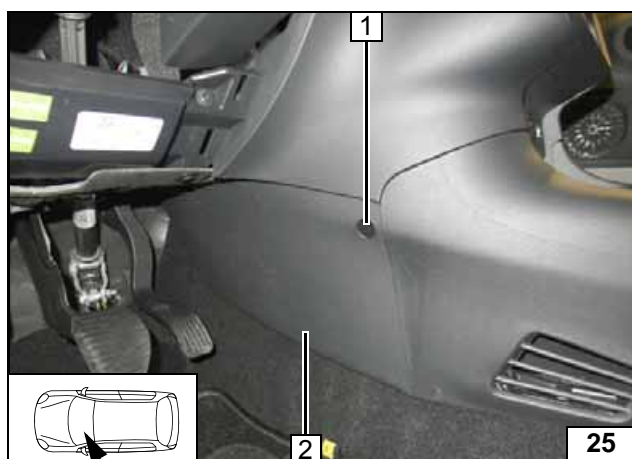

1 Original vehicle bolt  
2 Detach centre console side trim from the clips on the left

Detaching centre console side trim from the clips on the left

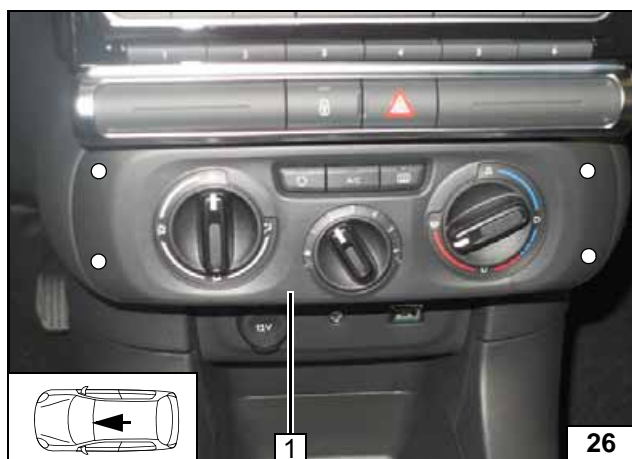

### Manual air-conditioning

Release trim piece 1 carefully!

- Fastening clip [4x]

Dismantling A/C control panel



1 Remove bolt [2x]

Press controls out of the bracket from behind, turn carefully round the longitudinal axis and disconnect the 12-pin connector. (Pay attention to the Bowden cable!)

Dismantling A/C control panel





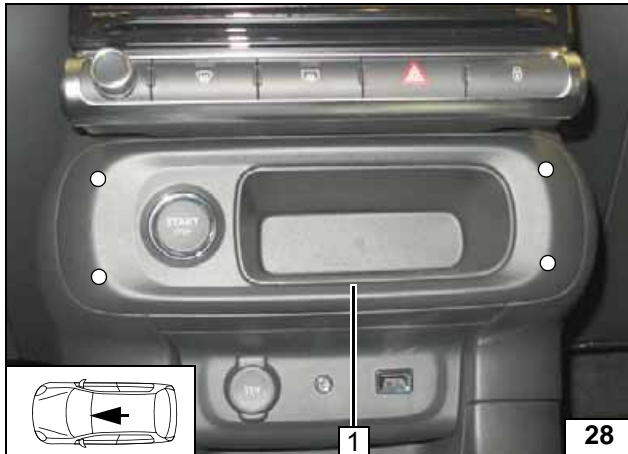

**Automatic air-conditioning**

- 1 Storage compartment with starter button
- Fastening clip [4x]

**Dismantling storage compartment**

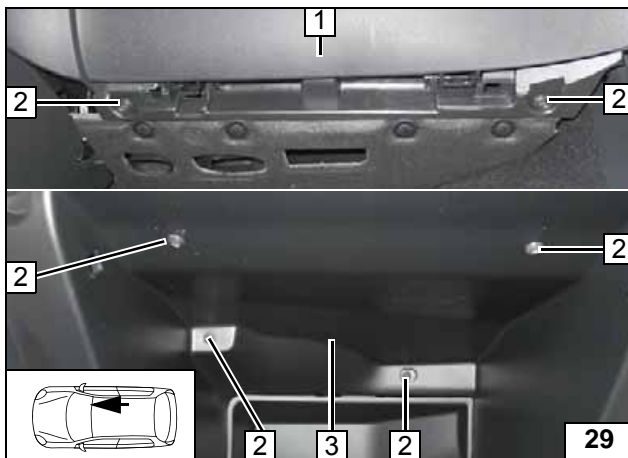

**All vehicles**

- 1 View of glove box from the footwell
- 2 Original vehicle bolt [6x]
- 3 Inside view of glove box

**Dismantling glove box**

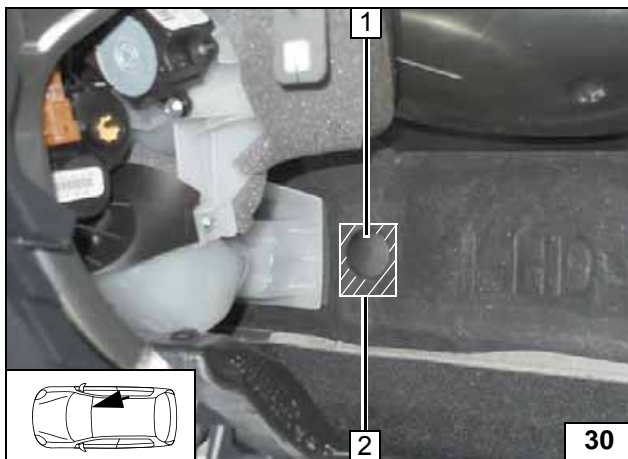

- 1 Discard original vehicle plastic nut.
- 2 Cut out insulation mat as shown

**Preparing passenger compartment relay and fuse holder installation location**

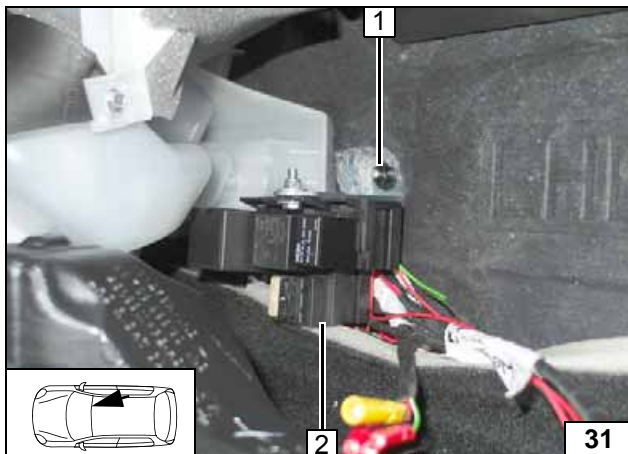

**Figure shows vehicle with automatic A/C.**

- 1 Plastic nut
- 2 Premounted passenger compartment relay and fuse holder

**Installing passenger compartment relay and fuse holder**

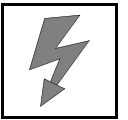

Manual Air-Conditioning Fan Controller



System wiring diagram

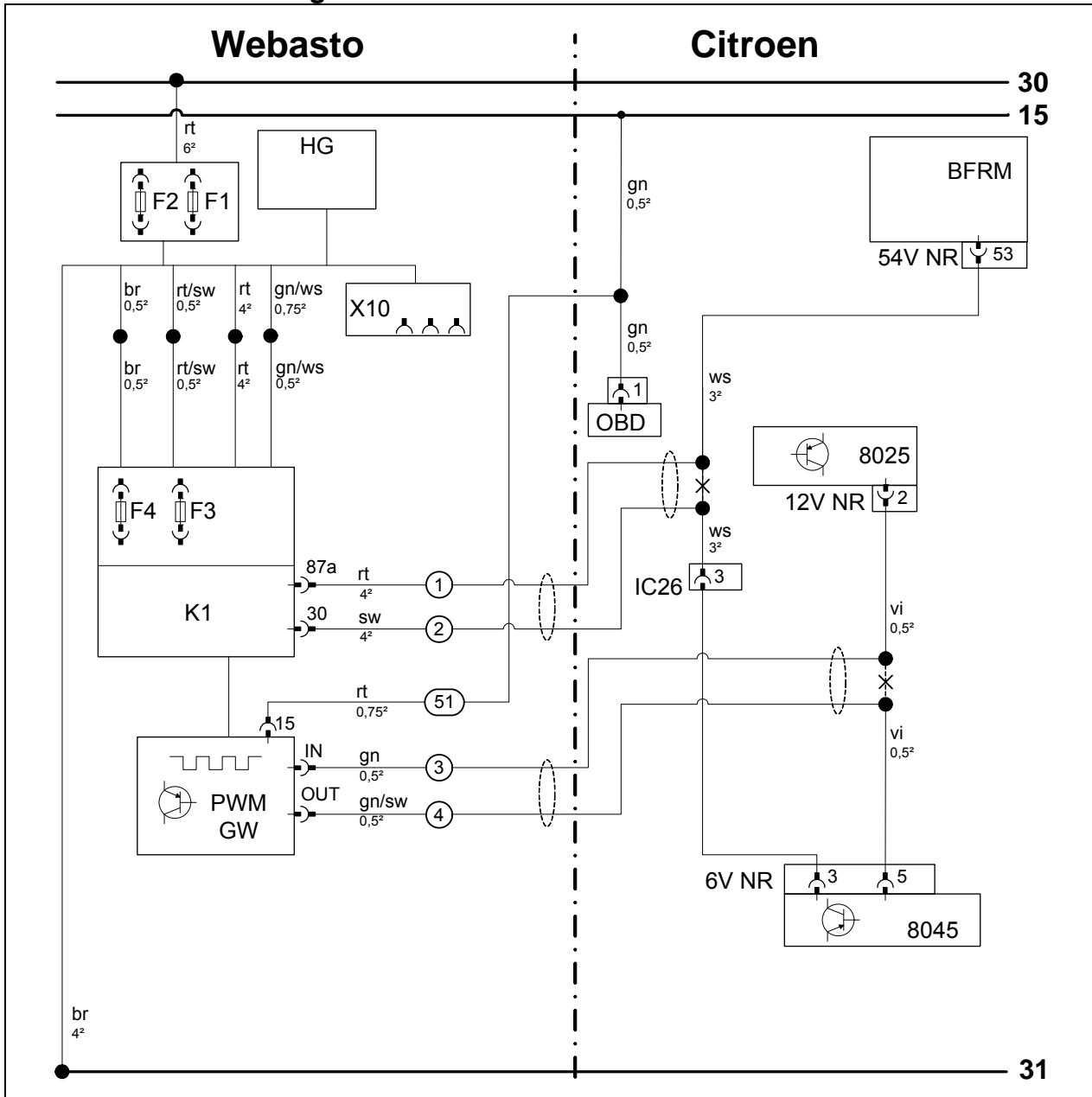

Webasto components		Vehicle components		Colours and symbols	
HG	TT-Evo heater	BFRM	Engine compartment fuse and relay carrier	rt	red
F1	20A fuse	54V NR	54-pin connector BFRM	sw	black
F2	30A fuse	BSI	Central electrical box	vi	violet
X10	4-pin socket of heater control	OBD	Socket outlet	gn	green
F3	1A fuse	8025	A/C control unit	br	brown
F4	25A fuse	12V NR	6-pin connector 8025	ws	white
K1	Fan relay	8045	Fan controller		
PWM-GW	Pulse width modulator	6V NR	6-pin connector 8045		
<b>Settings of PWM GW:</b>					
Duty cycle: 70%					
Frequency: 400Hz					
Voltage: not relevant				X	Cutting point
Function: Low side					Wiring colours may vary.

Legend

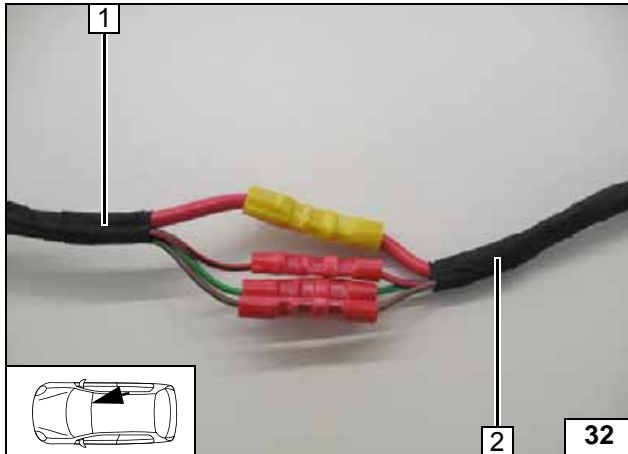
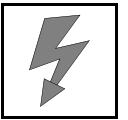

- 1 Passenger compartment relay and fuse holder wiring harness
- 2 Heater wiring harness

**Connecting same colour wires of wiring harnesses**

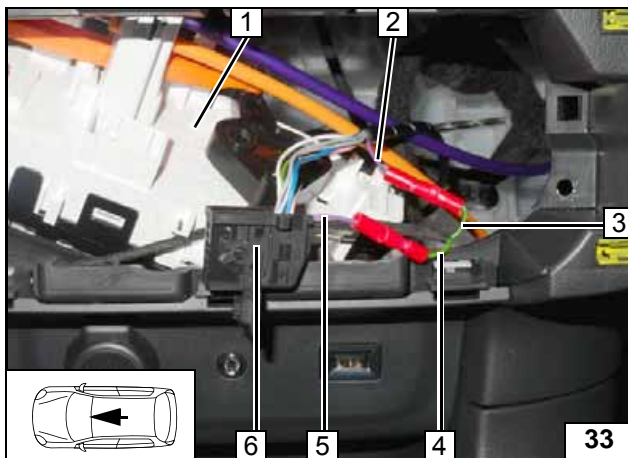

- 1 Controls/ control unit 8025
- 2 Violet (vi) wire to fan controller 8045/ pin 5
- 3 Green/black (gn/sw) wire of PWM GW/ OUT
- 4 Green (gn) wire of PWM GW/ IN
- 5 Violet (vi) wire of 12V NR/ pin 2
- 6 Connector 12V NR

**Connecting fan controller**

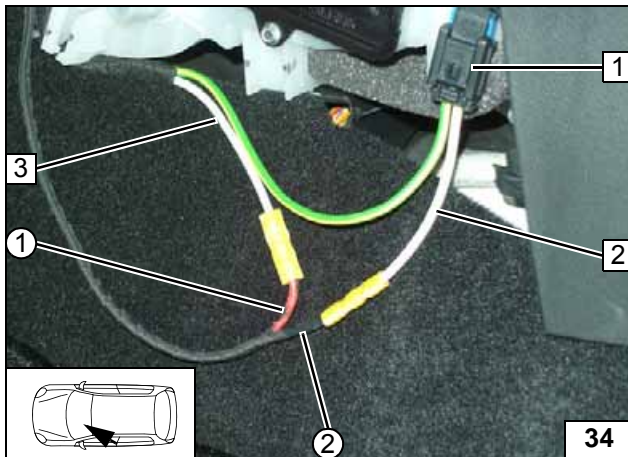

- 1 2-pin connector IC26
- 2 White (ws) wire of connector IC26/ pin 3
- 3 White (ws) wire of fuse and relay carrier BFRM connector 54V NR/ pin 53
- ① Red (rt) wire of K1/87a, fan wiring harness
- ② Black (sw) wire of K1/30, fan wiring harness

**Connecting fan motor**

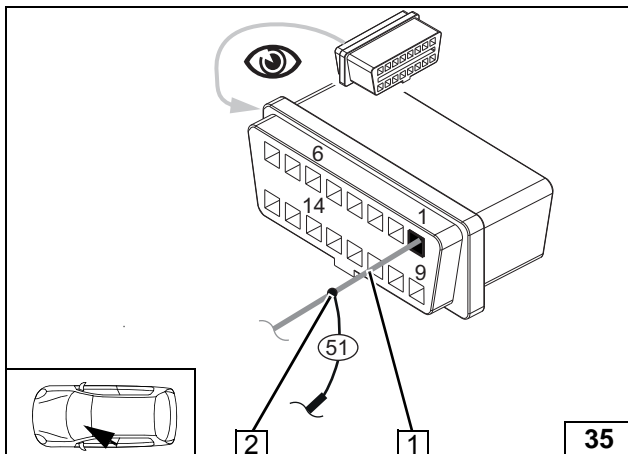

Remove OBD socket outlet from bracket.



- 1 Green (gn) wire of OBD socket outlet/ pin 1
- 2 Butt connector
- ⑤1 Red (rt) wire of PWM GW/ KL15

**Connecting terminal 15**





Automatic Air-Conditioning Fan Controller

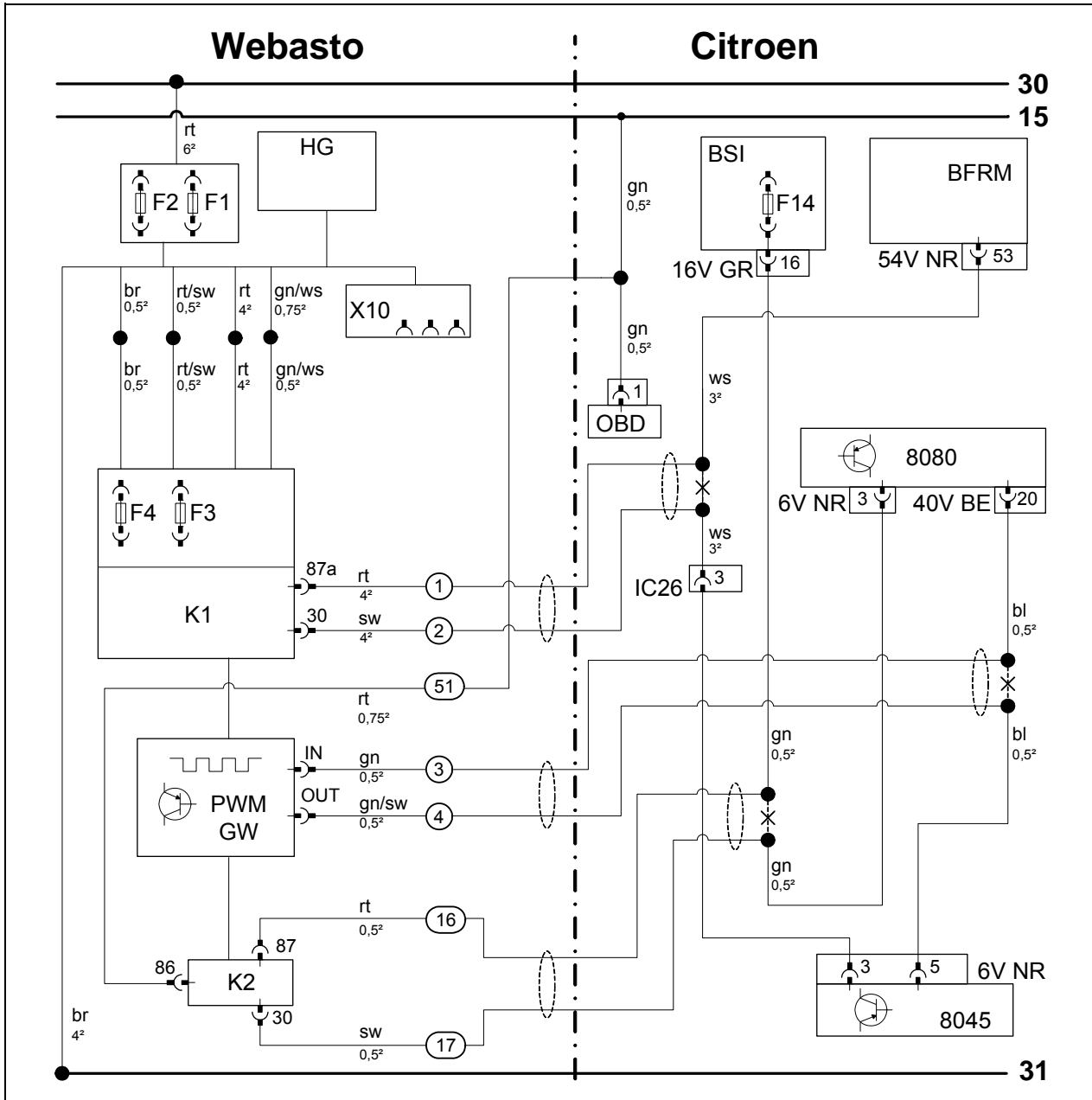

System wiring diagram

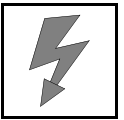

Webasto components		Vehicle components		Colours and symbols	
HG	TT-Evo heater	BFRM	Engine compartment fuse and relay carrier	rt	red
F1	20A fuse			sw	black
F2	30A fuse	54V NR	54-pin connector BFRM	bl	blue
X10	4-pin socket of heater control	BSI	Central electrical box	gn	green
		F14	Fuse	br	brown
F3	1A fuse	16V GR	16-pin connector BSI	ws	white
F4	25A fuse	OBD	Socket outlet		
K1	Fan relay	8080	A/C control unit		
PWM-GW	Pulse width modulator	40V BE	40-pin connector 8025		
K2	Additional relay	6V NR	6-pin connector 8025		
<b>Settings of PWM GW:</b>		IC26	2-pin connector		
Duty cycle:	70%	8045	Fan controller		
Frequency:	400Hz	6V NR	6-pin connector 8045		
Voltage:	not relevant			X	Cutting point
Function:	Low side			Wiring colours may vary.	

Legend

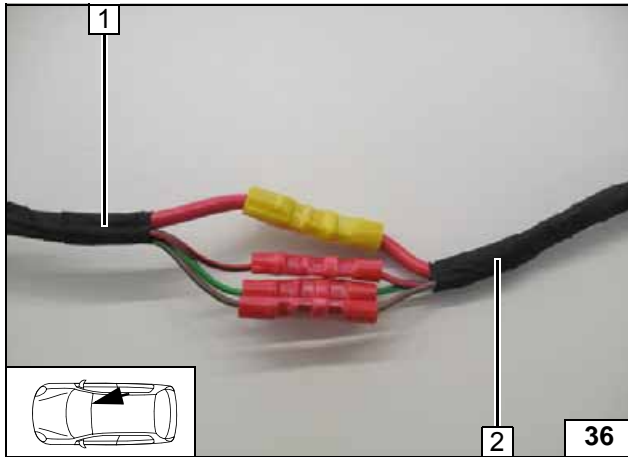

- 1 Passenger compartment relay and fuse holder wiring harness
- 2 Heater wiring harness

Connecting same colour wires of wiring harnesses

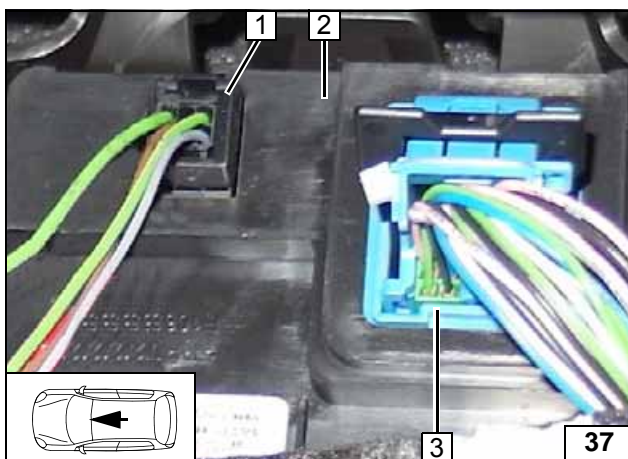

- 1 6-pin connector 6V NR
- 2 A/C control unit
- 3 40-pin connector 40V BE

Assigning A/C control unit connector

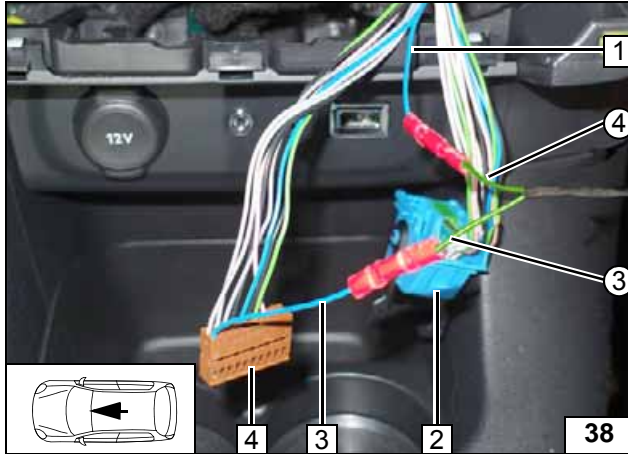
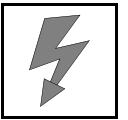

Disconnect connector 40V BE 2 from A/C control unit and disassemble!



- 1 Blue (bl) wire of fan controller connector/ pin 5
- 3 Blue (bl) wire of 40V BE/ pin 20
- 4 Brown contact strip of connector 40V BE/ pin 1-20
- ③ Green (gn) wire from PWM GW/ IN of PWM control wiring harness
- ④ Green/black (gn/sw) wire from PWM GW/ OUT of PWM control wiring harness

**Connect-  
ing fan con-  
troller**

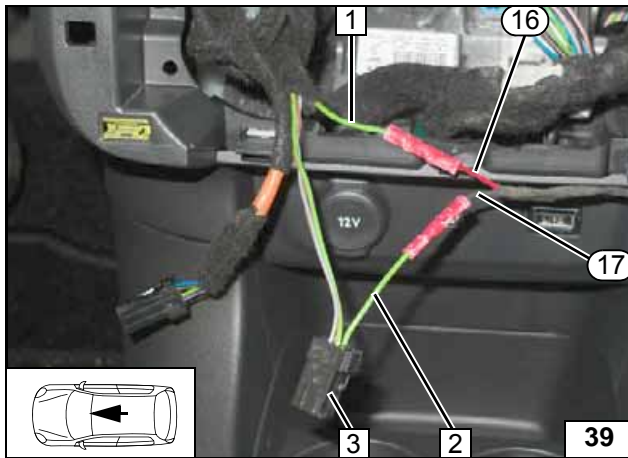

Connection to 6-pin connector 6V NR 3 from A/C control unit.



- 1 Green (gn) wire of BSI
- 2 Green (gn) wire of connector 6V NR/ pin 3
- ⑩⑥ Red (rt) wire from K2/87 of isolating relay wiring harness
- ⑩⑦ Black (sw) wire from K2/30 of isolating relay wiring harness

**Connecting  
A/C control  
unit**

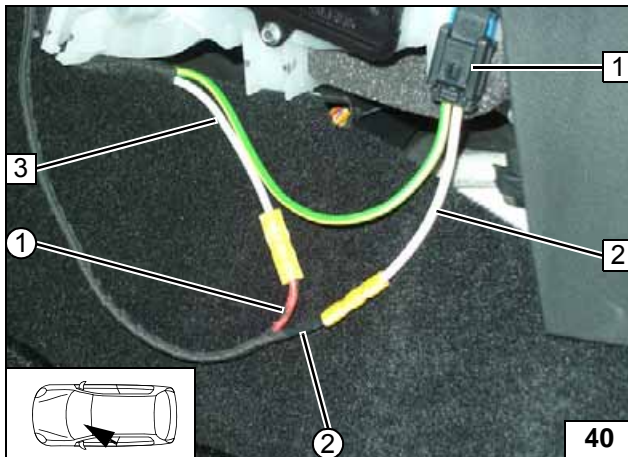

- 1 2-pin connector IC26
- 2 White (ws) wire of connector IC26/ pin 3
- 3 White (ws) wire of fuse and relay carrier BFRM connector 54V NR/ pin 53
- ① Red (rt) wire of K1/87a, fan wiring harness
- ② Black (sw) wire of K1/30, fan wiring harness

**Connect-  
ing fan mo-  
tor**

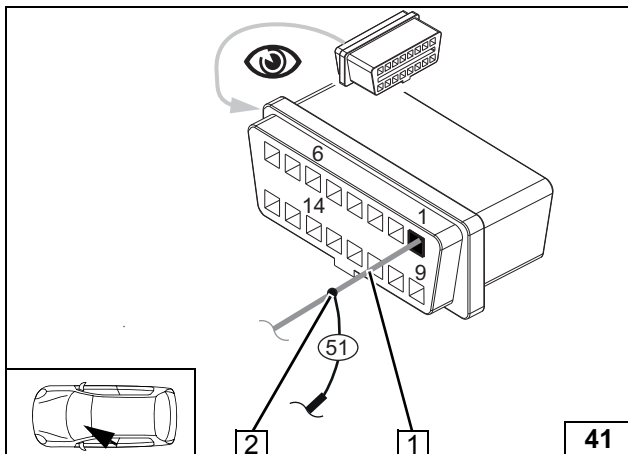

Remove OBD socket outlet from bracket.



- 1 Green (gn) wire of OBD socket outlet/ pin 1
- 2 Butt connector
- ⑤① Red (rt) wire of K2/86

**Connect-  
ing terminal  
15**

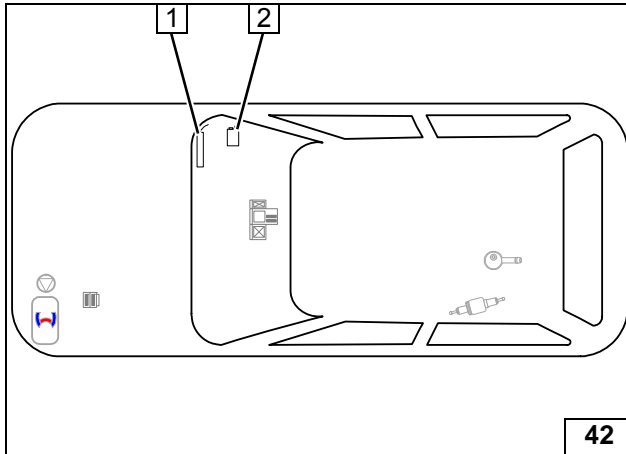
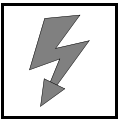

### Heater Control Installation

- 1 Telestart / ThermoCall aerial
- 2 Telestart / ThermoCall receiver



#### Installation overview

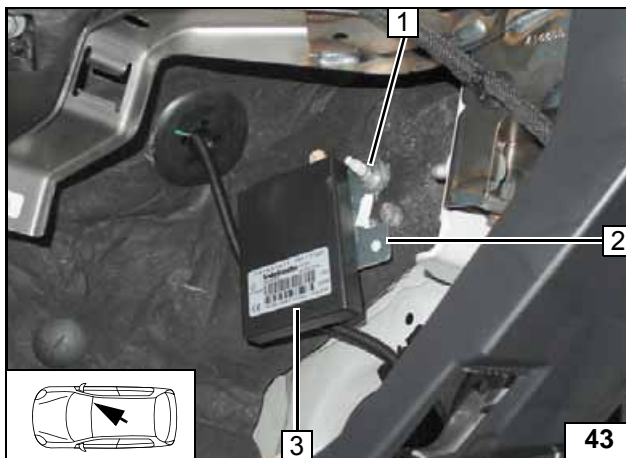

### Remote Option (Telestart)

Drill out Telestart bracket 2 at position 1 to 7mm dia.  
Place a 5mm spacer at position 1 between Telestart bracket and vehicle.

- 1 Flanged nut
- 3 Receiver



#### Installing receiver

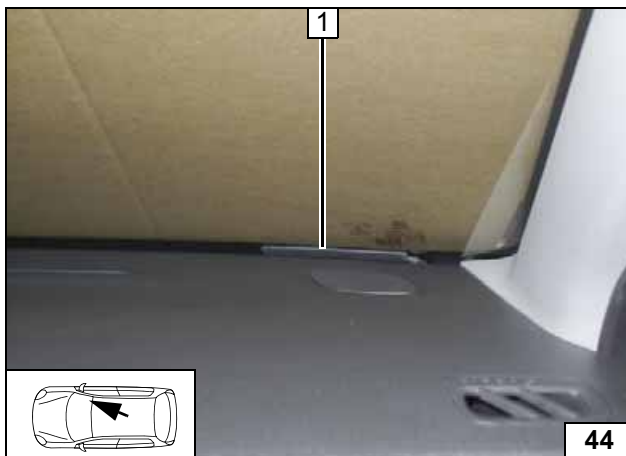

- 1 Aerial

#### Installing aerial

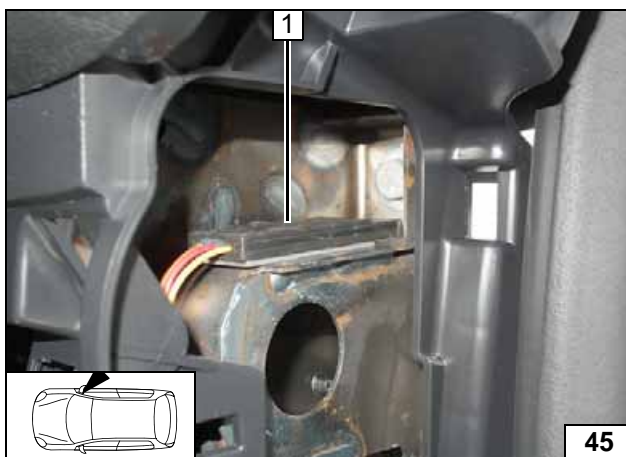

### Temperature sensor T100 HTM

Fasten temperature sensor 1 with double-sided adhesive tape.



#### Installing temperature sensor

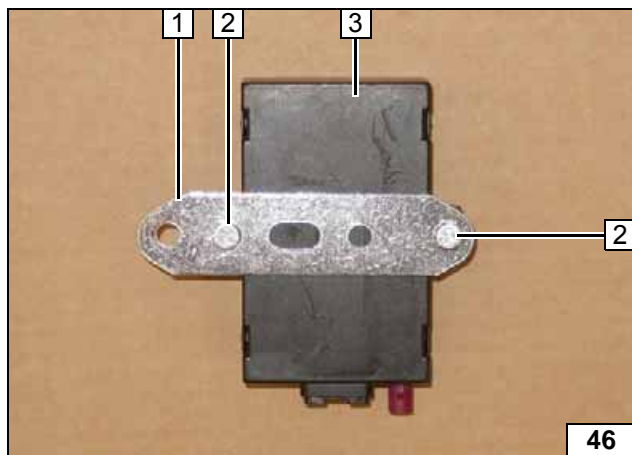
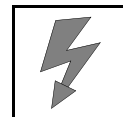

### ThermoCall Option

- 1 Perforated bracket
- 2 M5x16 bolt, flanged nut
- 3 Receiver



#### Premounting receiver

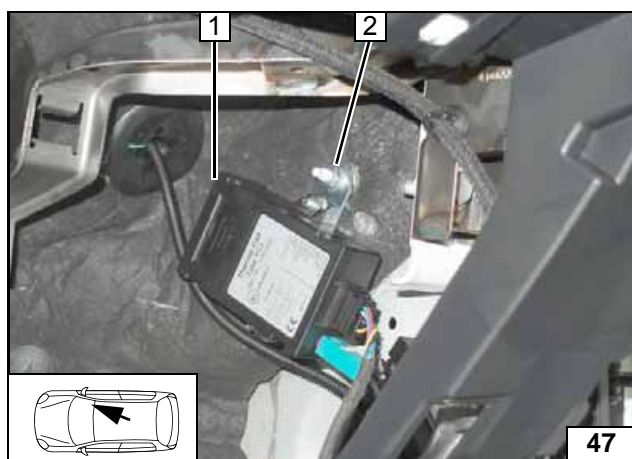

Place a 5mm spacer at position 2 between perforated bracket and vehicle.

- 1 Premounted receiver
- 2 Flanged nut



#### Installing receiver

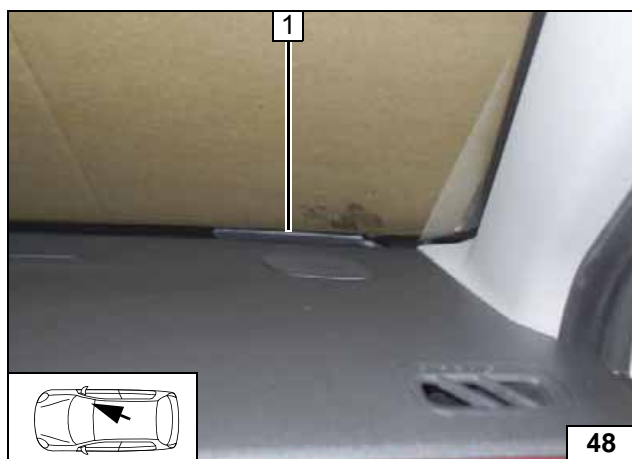

- 1 Aerial (optional)

#### Installing aerial



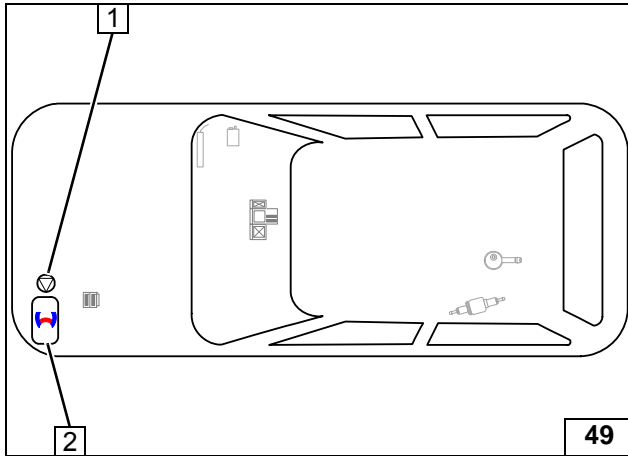
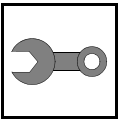

### Preparing Installation Location

- 1 Circulating pump
- 2 Heater



Installation overview

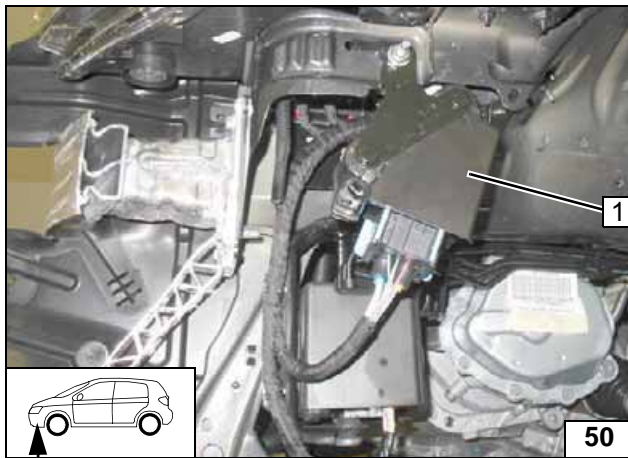

Remove control unit 1 with bracket, if present!



Removing original vehicle relay

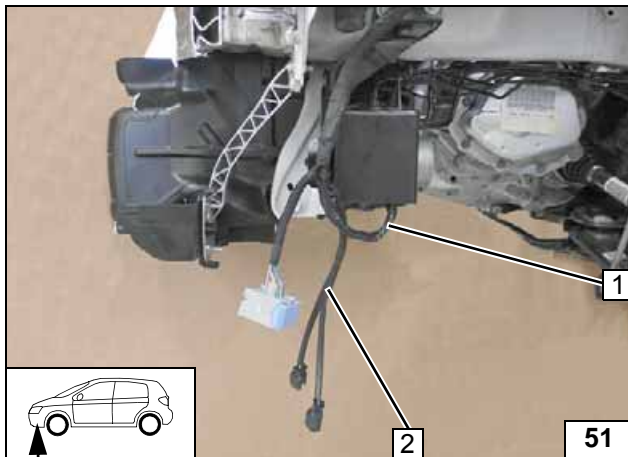

Separate original vehicle wires 2 from original vehicle wiring harness 1 and insulate.



Installing original vehicle wiring harness

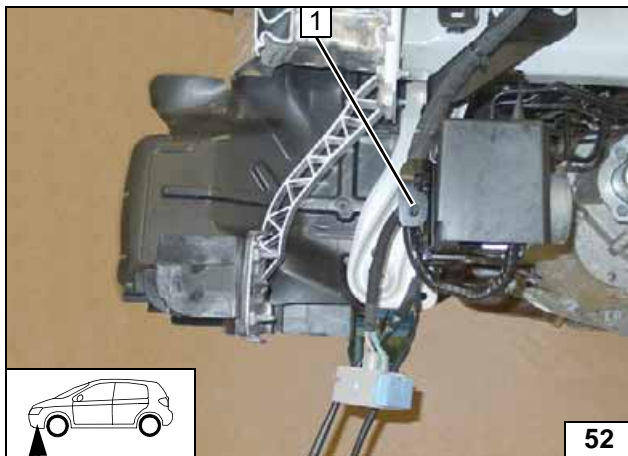

1 Install original vehicle clip as shown

Installing original vehicle wiring harness

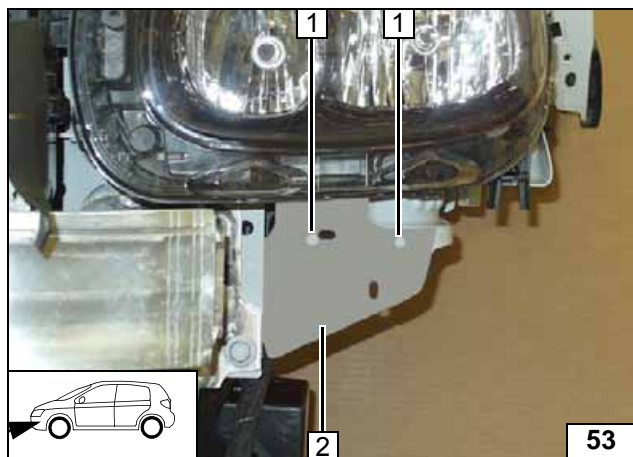
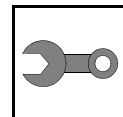

Cut out template 2, position as shown.

- 1 Copy hole pattern, 7mm dia. hole [2x each]



**Copying hole pattern**

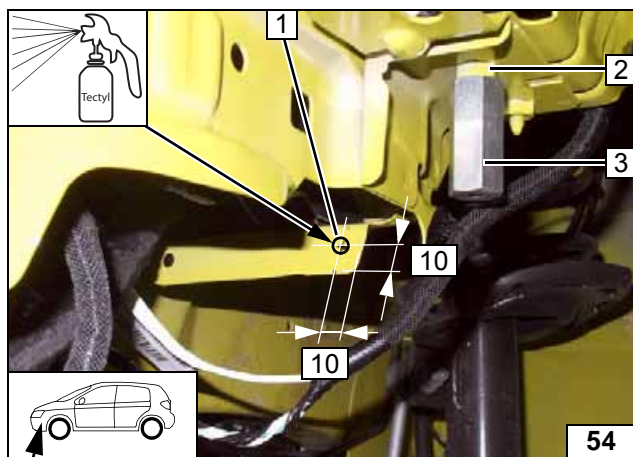

Remove bolt at position 2, will be reused!

- 1 7 mm dia. hole
- 3 M6x20 bolt, spring lockwasher, large diameter washer, 40mm spacer nut



**Copying hole pattern**

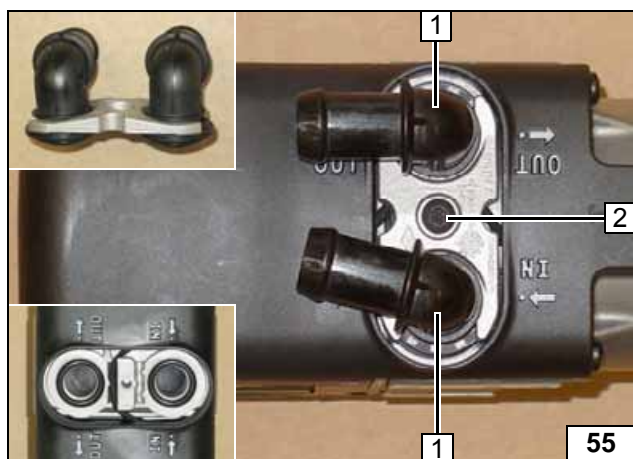

**Preparing Heater**

- 1 Water connection piece, sealing ring [2x each]
- 2 5x15 self-tapping bolt, retaining plate of water connection piece



**Installing water connection piece**

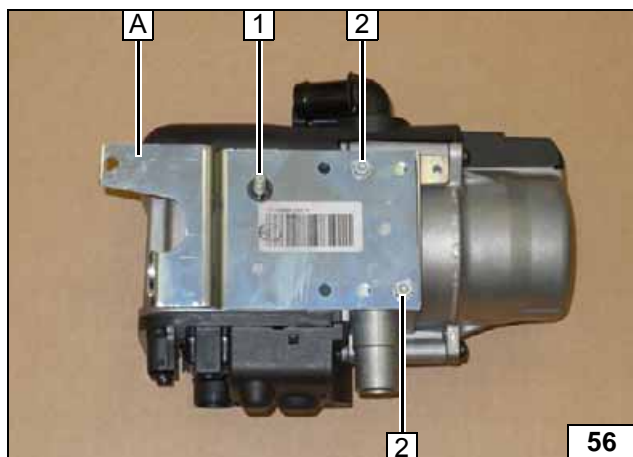

Prepare bracket A in accordance with the template!

- 1 M6x25 bolt, lock washer
- 2 5x13 self-tapping bolts [2x]



**Installing bracket A**

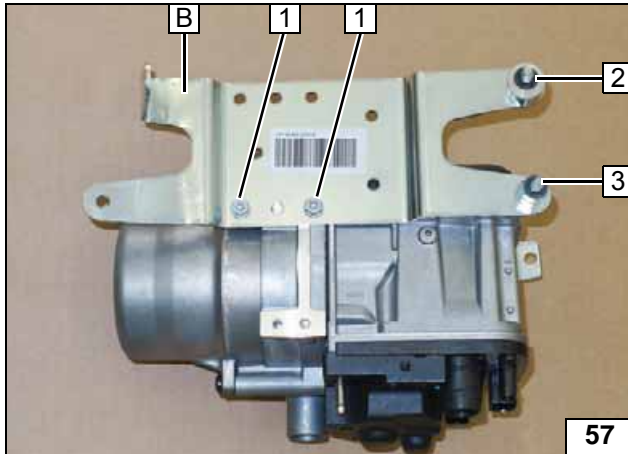
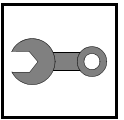

Prepare bracket **B** in accordance with the template!



- 1 5x13 self-tapping bolts [2x]
- 2 M6x25 bolt, 10mm spacer, lock washer
- 3 M6x25 bolt, M8 nut [2x], lock washer

**Installing bracket B**

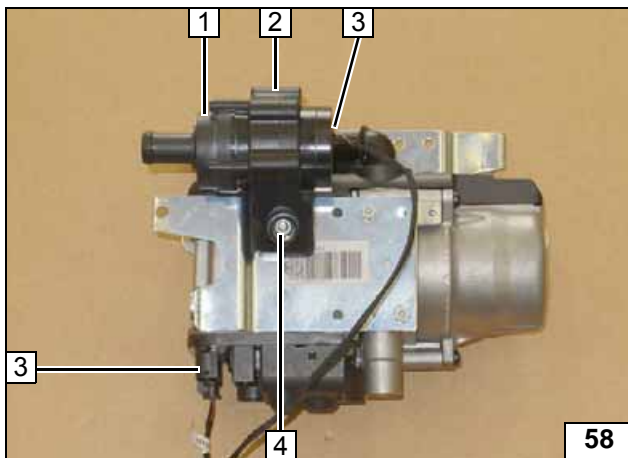

- 1 Circulating pump
- 2 Circulating pump mount
- 3 Connector of circulating pump wiring harness [2x]
- 4 Flanged nut

**Installing circulating pump**

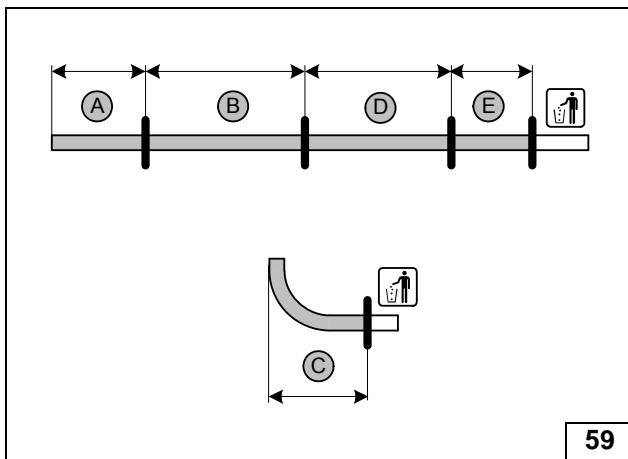

- A = 350
- B = 560
- C = 100
- D = 750
- E = 330

**Cutting hoses to length**

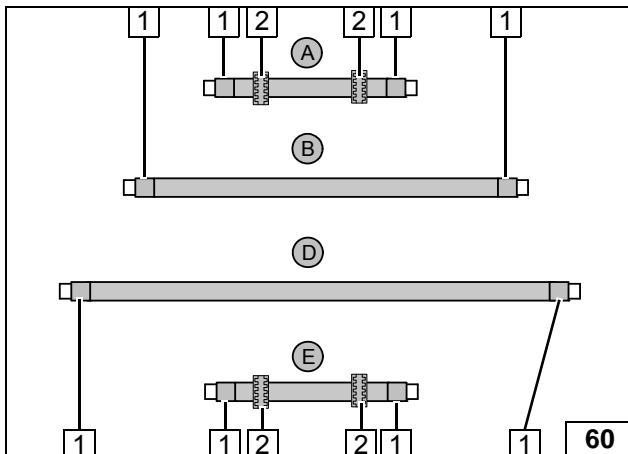

Push braided protection hoses onto hoses **A, B, D** and **E** and cut to length. Cut heat shrink plastic tubing to size.



- 1 50 mm long heat shrink plastic tubing [8x]
- 2 Black (sw) rubber isolator [4x]

**Preparing hoses**



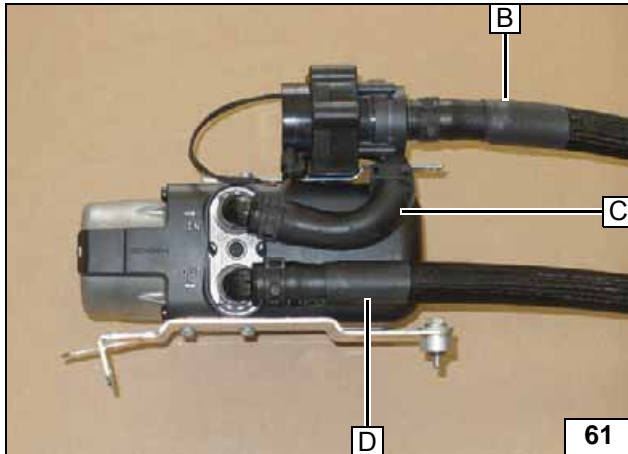
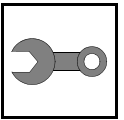

All spring clips = 25mm dia.!



Premounting hoses

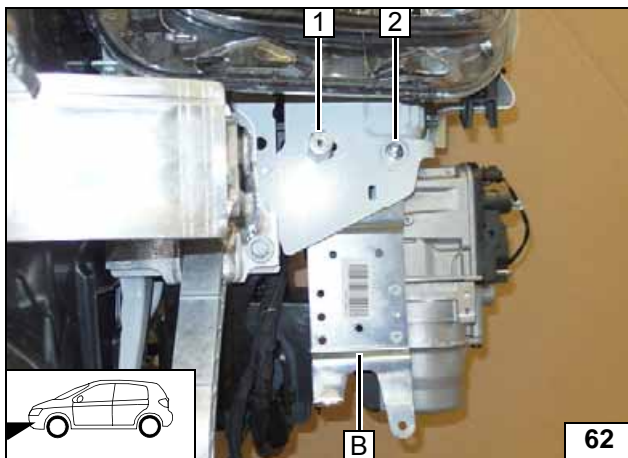

### Installing Heater

Route premounted water hose in the engine compartment.  
Suspend heater with bracket **B** at position **1** and **2** and mount loosely.



Installing heater

- 1 Loosely mount M6x30 spacer nut
- 2 Install large diameter washer, flanged nut loosely

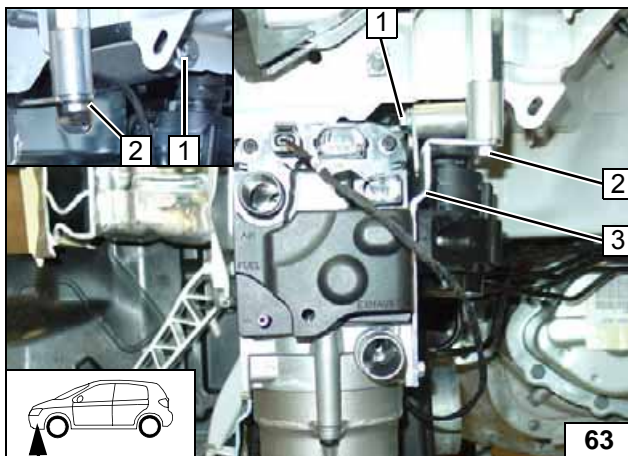

- 1 Install M6x60 bolt, large diameter washer, 40mm shim, 10mm shim, flanged nut loosely
- 2 Install M6x40 bolt, spring lockwasher, 30mm shim on spacer nut loosely
- 3 Bracket **A**



Installing heater

Align heater.  
Tighten all the screw connections.

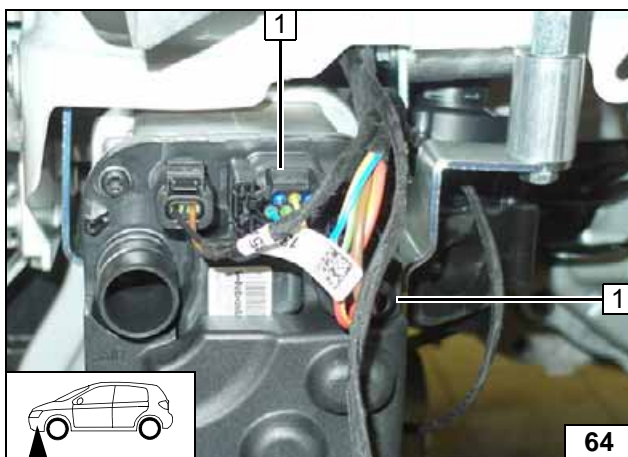

- 1 Heater wiring harness connector [2x]

Installing heater wiring harness

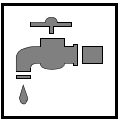

**Coolant Circuit**







Any coolant running off should be collected in an appropriate container. Route hoses kink-free. Unless specified otherwise, always fasten using cable ties. Position clamps so that other hoses cannot be damaged. The heater must be filled with coolant when installing the hoses.

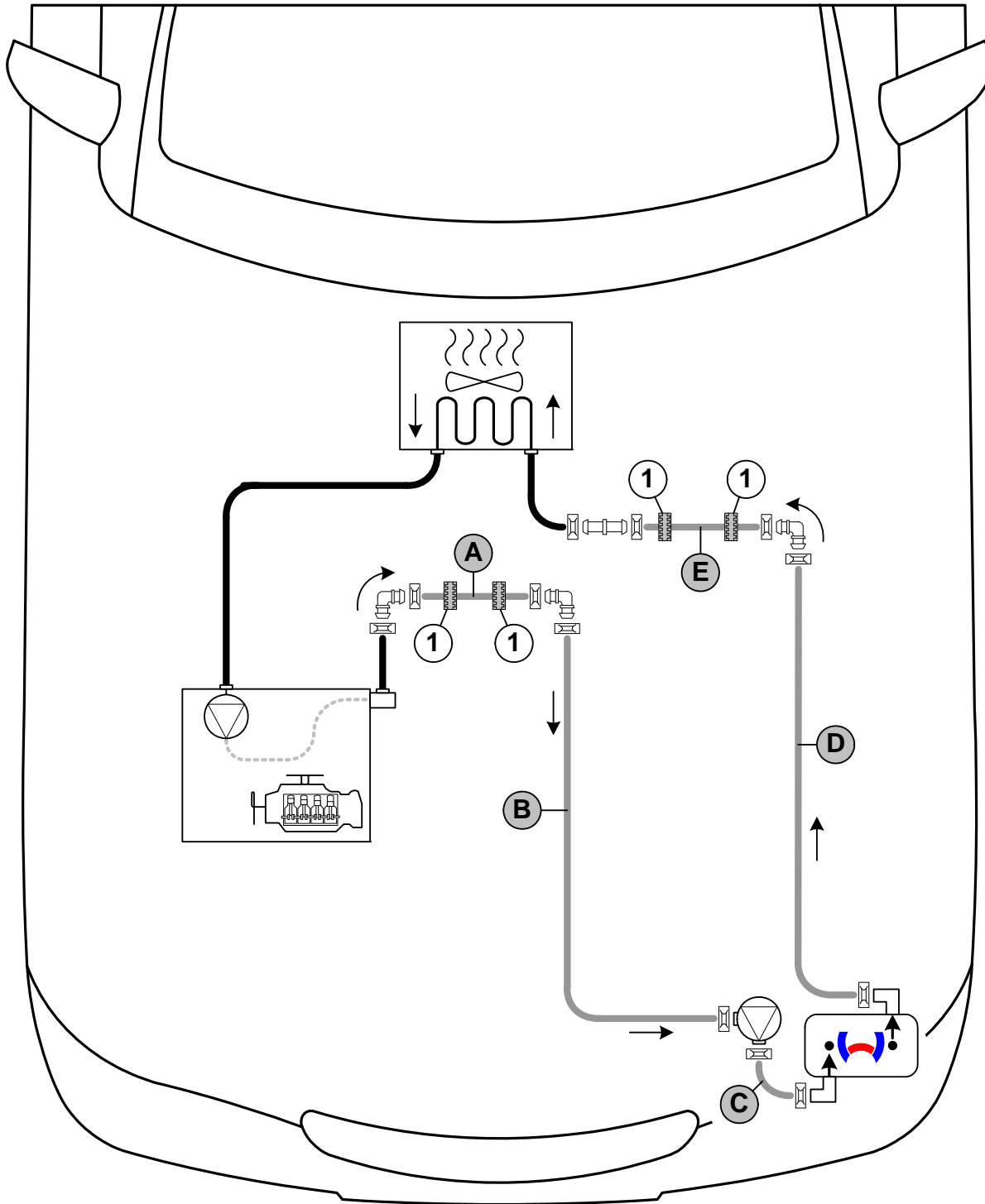

The connection should be modelled on an 'inline' circuit and based on the following diagram:



Hose routing diagram

All spring clips  = 25 mm dia. All connecting pipes  and  = 18x18 mm dia.  
 1 = Black (sw) rubber isolator .



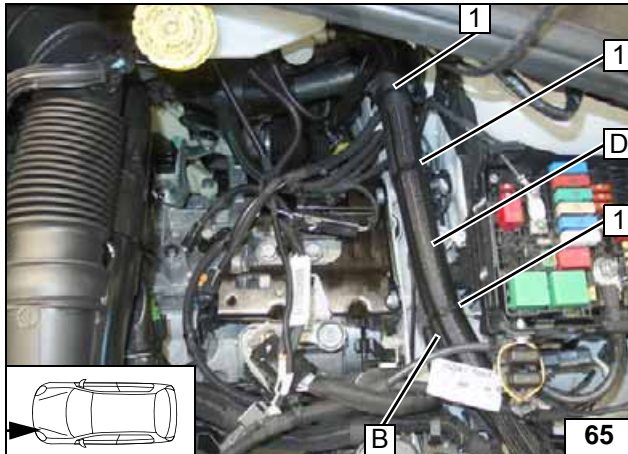

Route hoses **D** and **B** to the firewall.

- 1 Cable tie [3x]



**Routing hoses D and B**

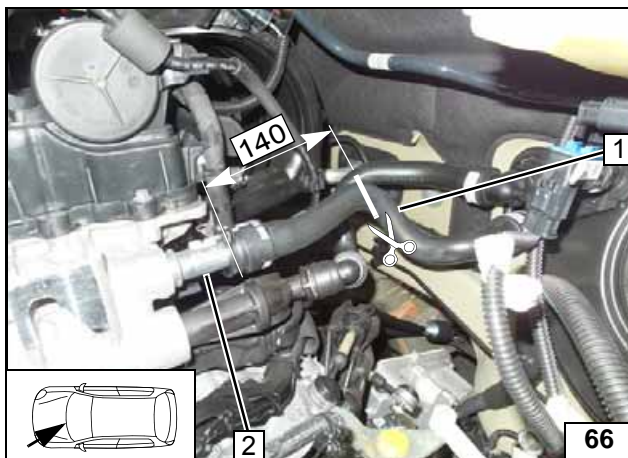

Cut off hose of engine outlet/heat exchanger inlet at the marking.

- 1 Heat exchanger inlet hose section
- 2 Engine outlet



**Cutting point**

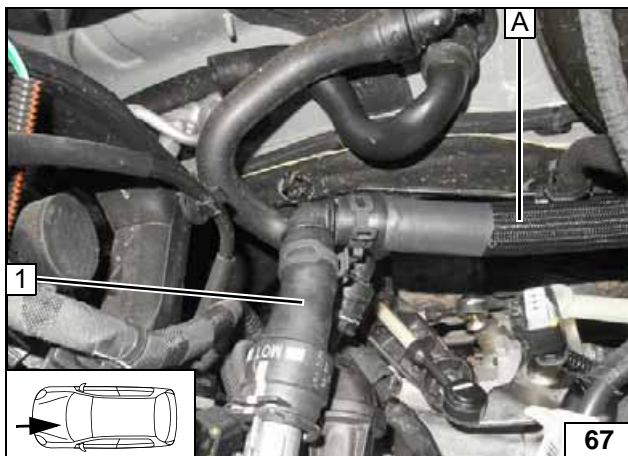

- 1 Engine outlet hose section

**Connecting engine outlet**

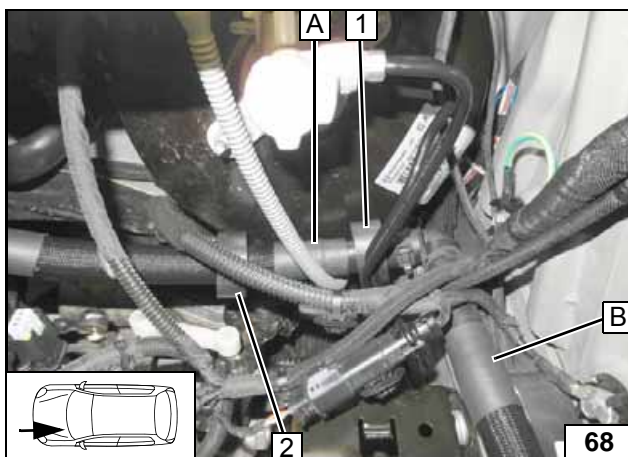

- 1 Align black (sw) rubber isolator with original vehicle wiring harness
- 2 Align black (sw) rubber isolator with original vehicle brake line

**Connecting hose A and B**



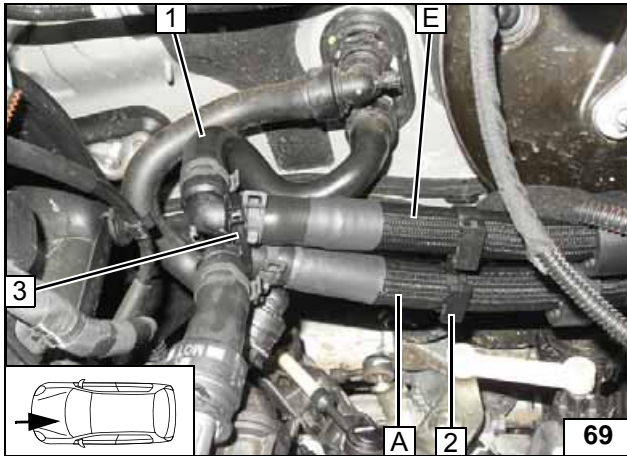

- 1 Heat exchanger inlet hose section
- 2 Hose bracket between hoses A and E
- 3 Cable tie

**Connect-  
ing heat ex-  
changer  
inlet**

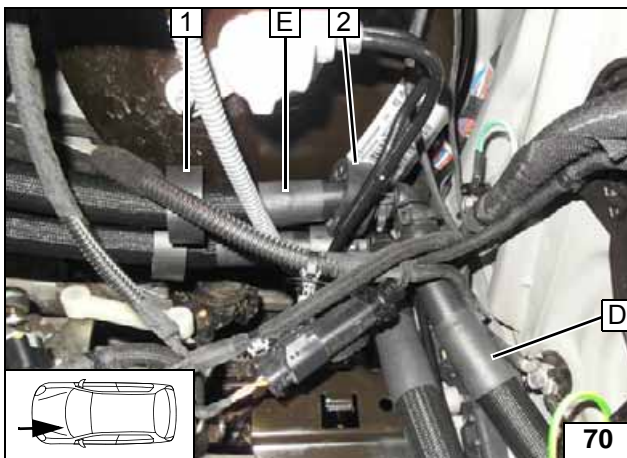

- 1 Align black (sw) rubber isolator with original vehicle wiring harness
- 2 Align black (sw) rubber isolator with original vehicle brake line

**Connect-  
ing hoses E  
and D**

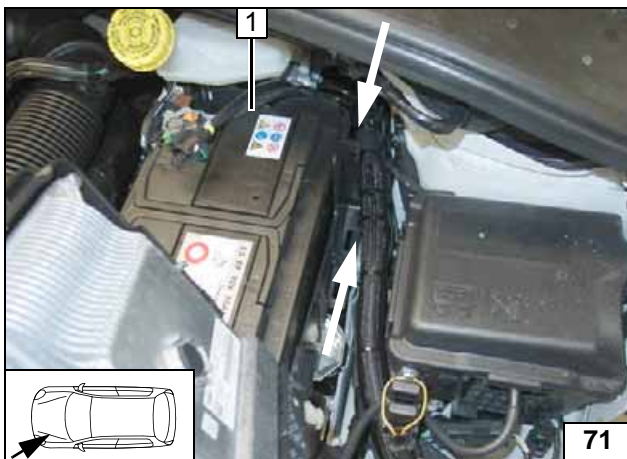

Align hoses. Ensure sufficient distance from neighbouring components, correct if necessary.

- 1 Battery

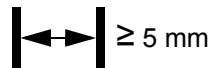

**Installing  
battery**

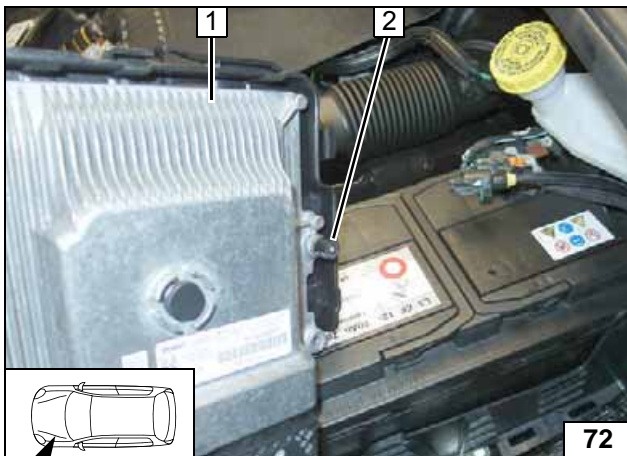

Fit 15mm long hose section 2 onto original vehicle bolt.

- 1 Engine control unit

**Installing  
hose sec-  
tion**

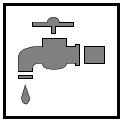

  $\geq 5 \text{ mm}$

Checking distance

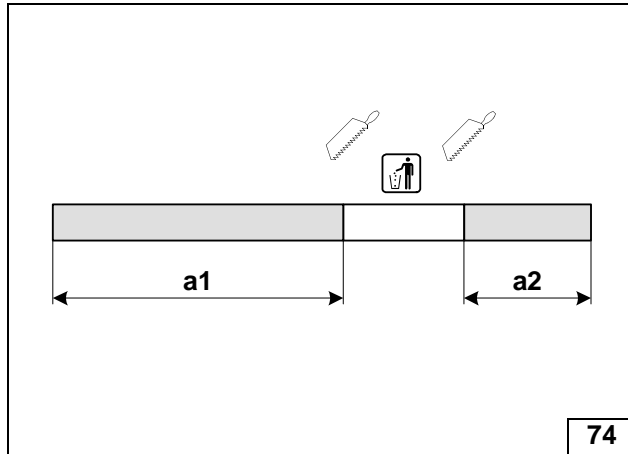
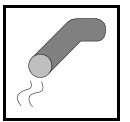

**Exhaust Gas**

a1 = 260  
a2 = 190

Preparing exhaust pipe

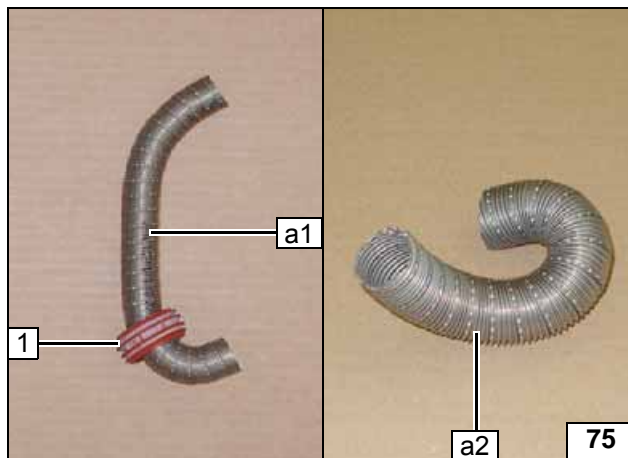

Bend exhaust pipes **a1** and **a2** as shown.



1 Spacer bracket

Preparing exhaust pipe a1 and a2

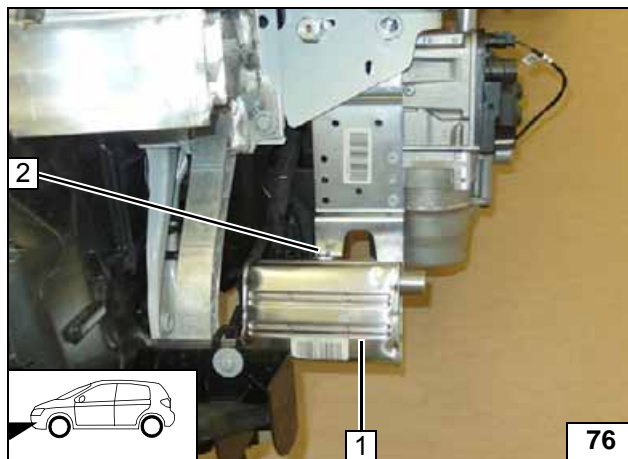

1 Silencer  
2 M6x16 bolt, spring lockwasher



Installing silencer

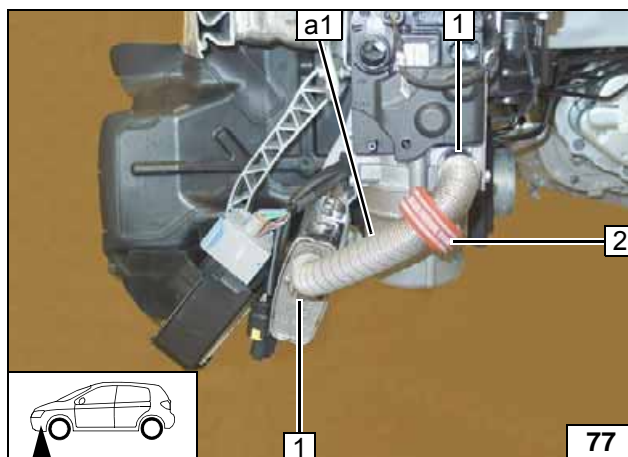

1 Hose clamp [2x]  
2 Spacer bracket

Installing exhaust pipe a1

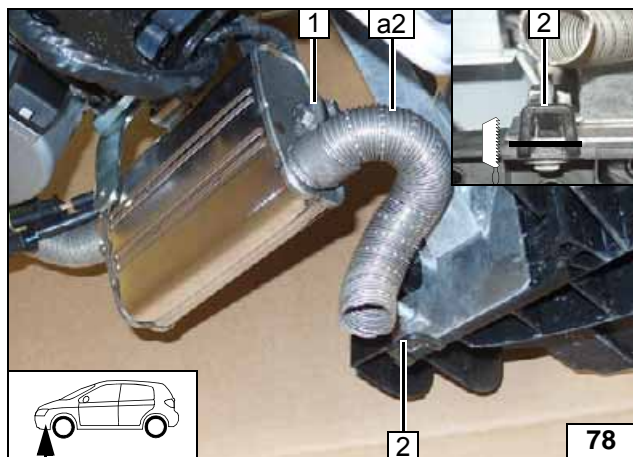
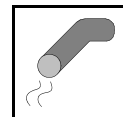

- 1 Hose clamp
- 2 Cut off original vehicle tab and discard

Installing exhaust pipe a2

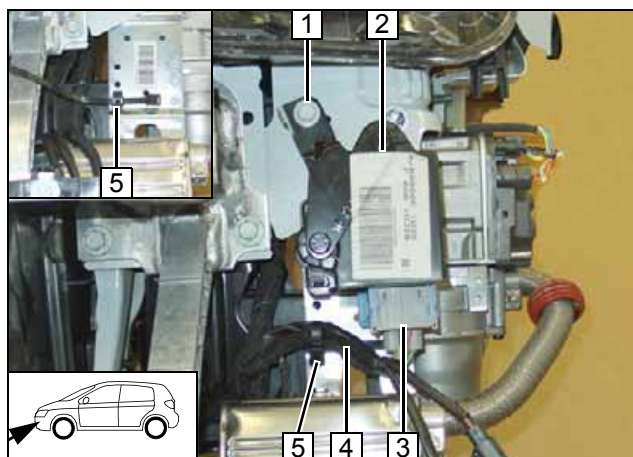

Secure original vehicle wiring harness 4 with clip-type cable tie 5.

- 1 Original vehicle bolt (see section Preparing installation location)
- 2 Control unit with bracket, if present
- 3 Connector mounted



Installing control unit

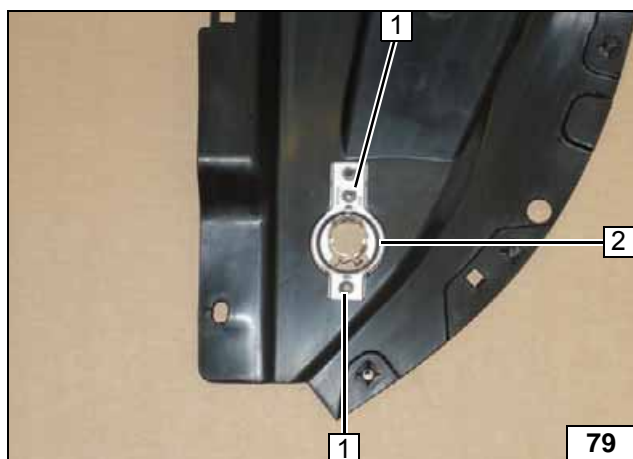

### Exhaust End Fastener Installation

Work step E3.

- 1 Hole pattern [2x]
- 2 Exhaust end fastener in existing hole



Copying hole pattern

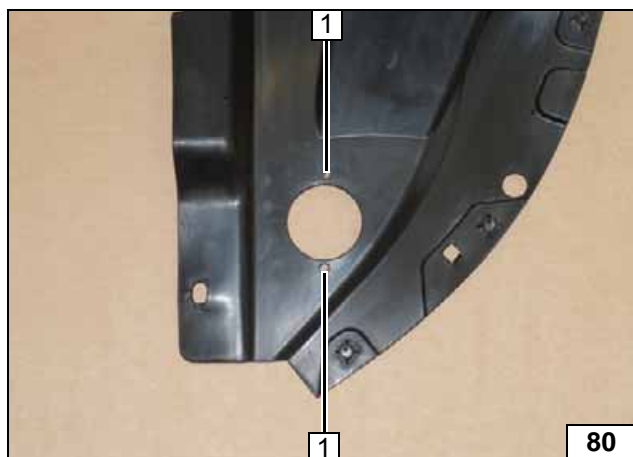

Work step E4.

- 1 Hole [2x]

Holes in under-ride protection

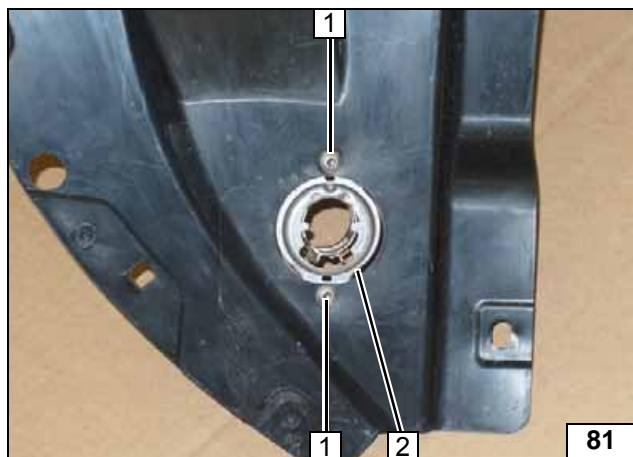
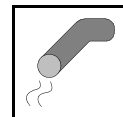

Work step E5.

- 1 5x13 self-tapping screw [2x]
- 2 Exhaust end fastener

**Installing ex-  
haust end fas-  
tener**



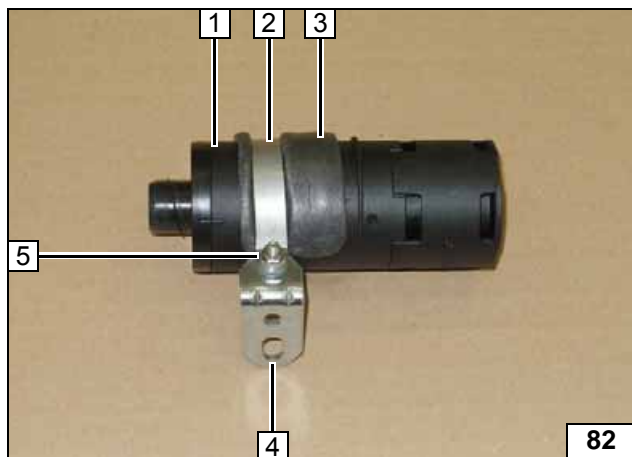
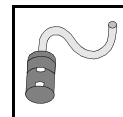

### Combustion Air

- 1 Silencer
- 2 51mm dia. clamp
- 3 Self-adhesive foam
- 4 Angle bracket
- 5 M5x16 bolt, flanged nut

Premount-  
silencer

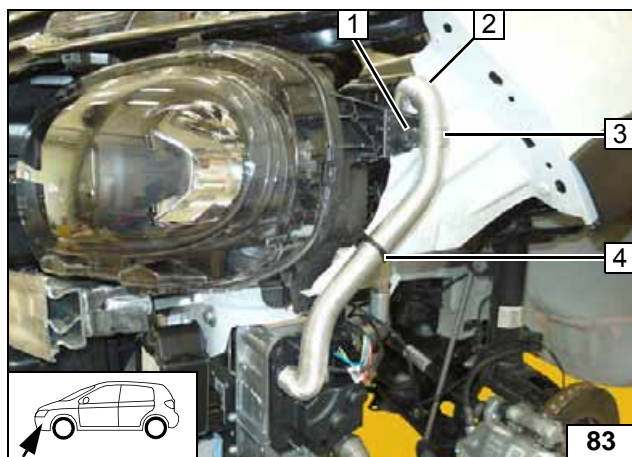

- 1 Original vehicle bolt
- 2 Combustion air pipe
- 3 24mm dia. p-clamp
- 4 Edge clip cable tie



Installing  
combus-  
tion air pipe



Connect silencer with combustion air pipe, then secure at position 1 as shown.

- 1 Original vehicle stud bolt, flanged nut



Installing  
silencer

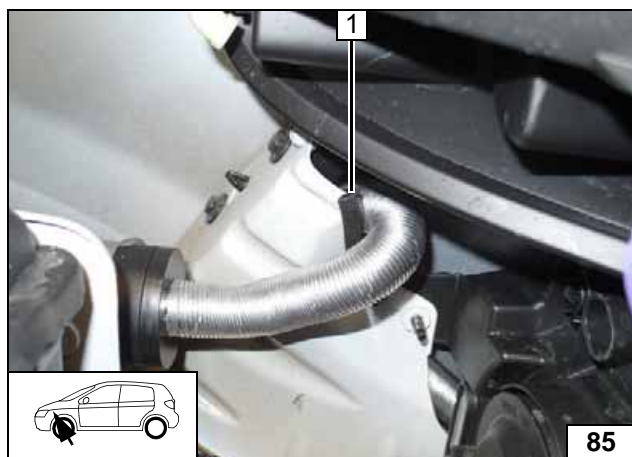

- 1 50 mm edge protection

Installing  
edge pro-  
tection

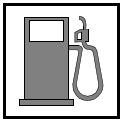

**Fuel**



Open the vehicle's fuel tank cap, ventilate the tank and then re-close the tank lock.

Catch any fuel running off in an appropriate container.

Route fuel line and metering pump wiring harness so that they are protected against stone impact. Unless specified otherwise, always fasten using cable ties.



Provide rub protection for fuel line and wiring harness in areas where there are sharp edges.

The fuel line and wiring harness are routed to the metering pump as shown in the wiring harness routing diagram.

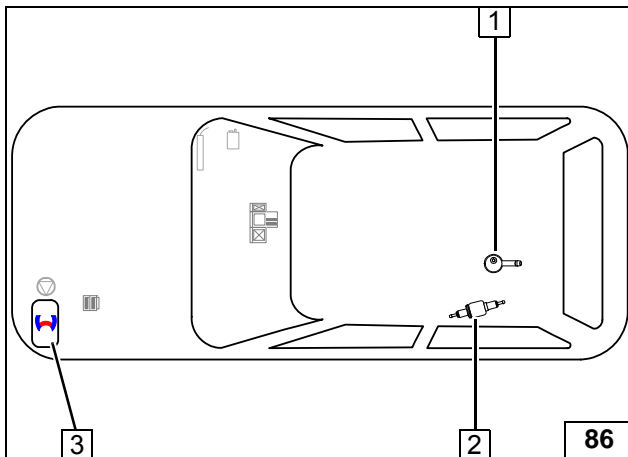

- 1 FuelFix
- 2 Metering pump
- 3 Heater



**Installation overview**

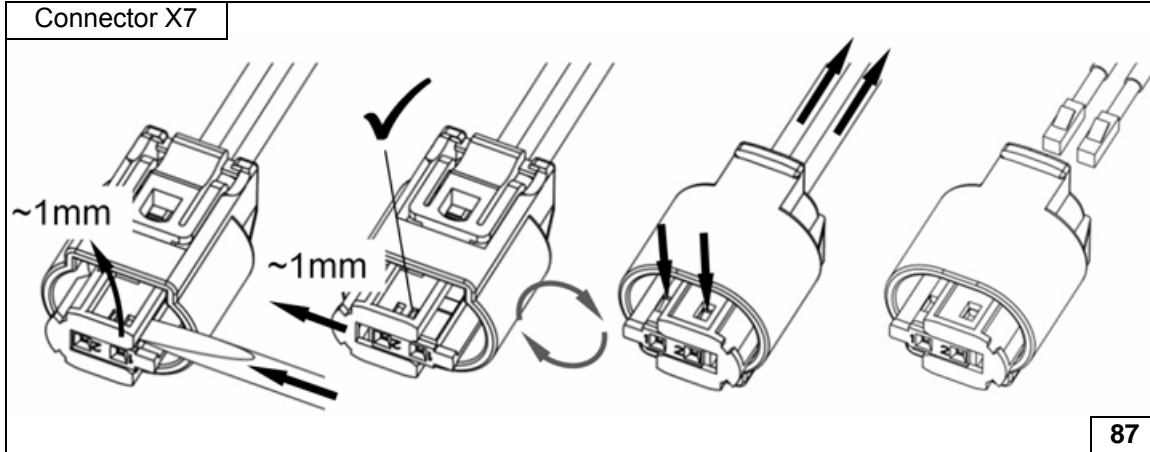

**Dismantling metering pump connector**

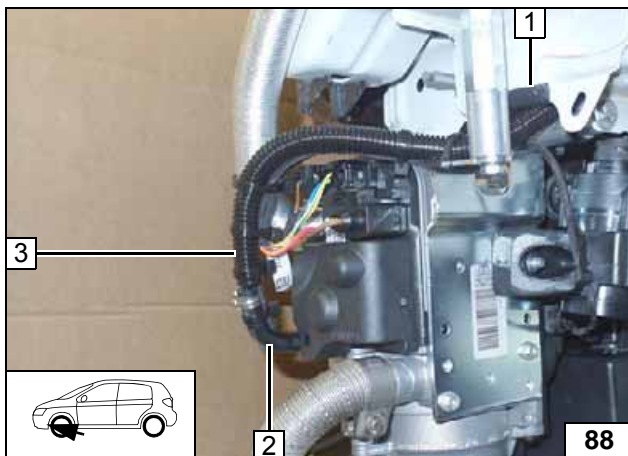

Draw fuel line and metering pump wiring harness into corrugated tube 3 and route in the engine compartment. Secure corrugated tube and heater wiring harness using cable ties.

- 1 Install 50mm edge protection
- 2 90° moulded hose, 10mm dia. clamp [2x]



**Connect-  
ing heater**

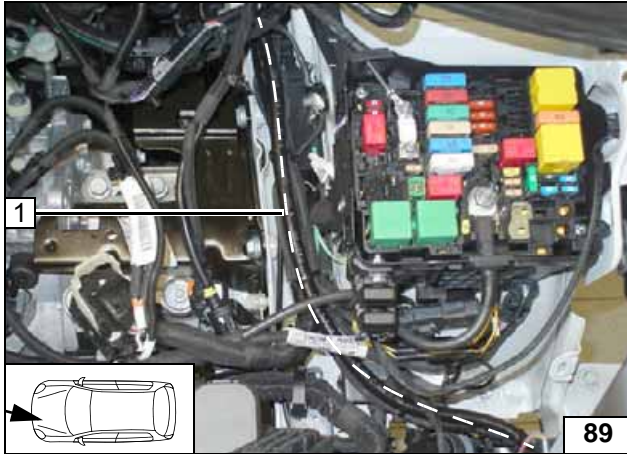
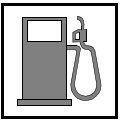

Route corrugated tube 1 with fuel line and metering pump wiring harness to the bulkhead and along original vehicle brake lines to the underbody, secure using cable ties!



Routing lines

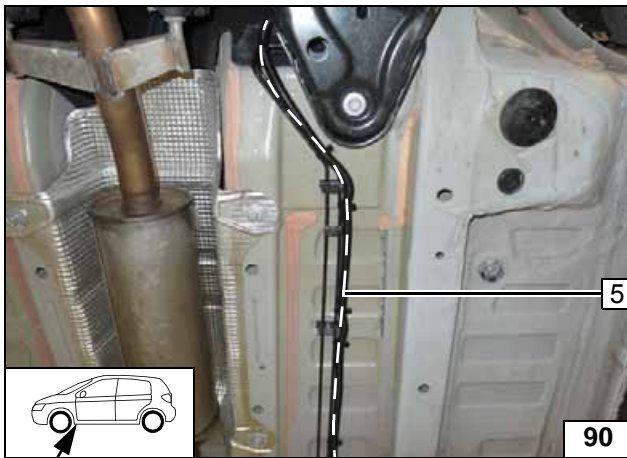

Route corrugated tube 1 with fuel line and metering pump wiring harness to the metering pump installation location and secure using cable ties!



Routing lines

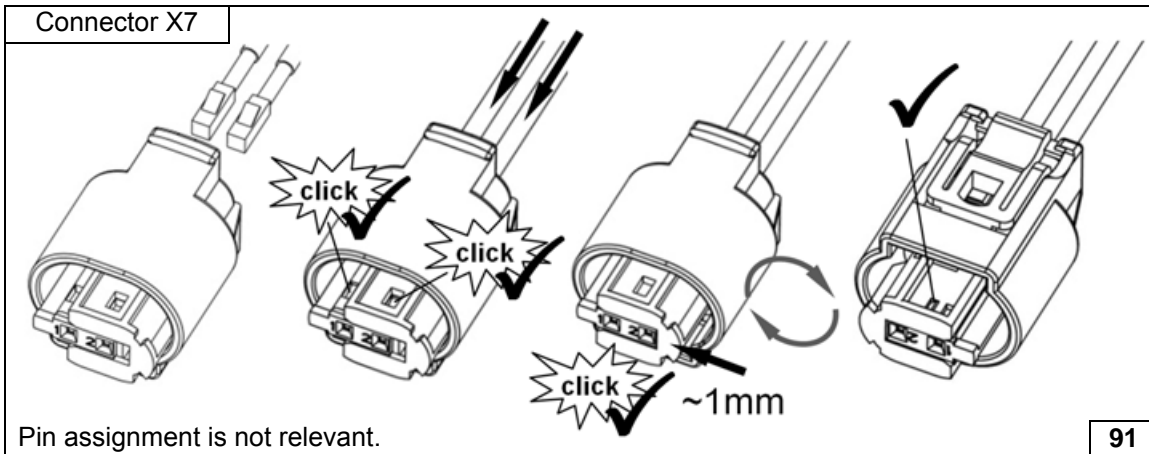

Completing metering pump connector

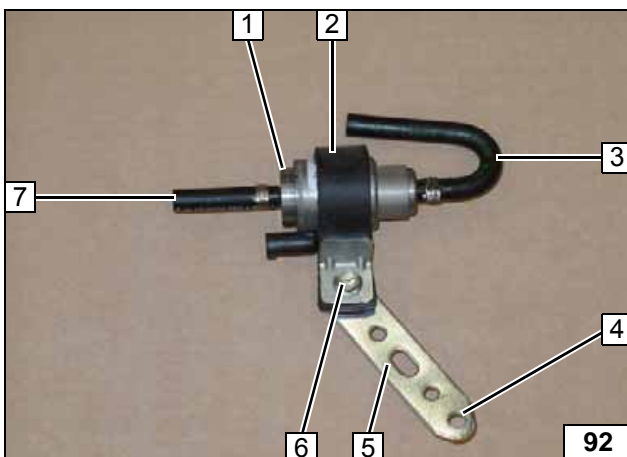

- 1 Metering pump
- 2 Metering pump mount
- 3 90° moulded hose, 10mm dia. clamp
- 4 Drill out hole to 8.5 mm dia.
- 5 Perforated bracket
- 6 M6x25 bolt, support angle bracket, flanged nut
- 7 Hose section, 10 mm dia. clamp



Pre-mounting metering pump



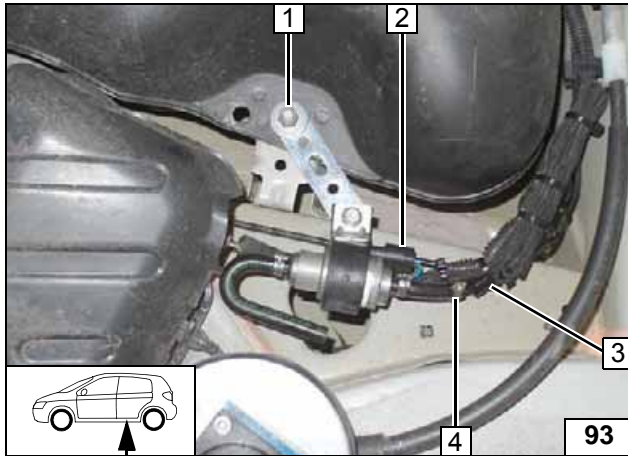
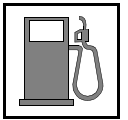

- 1 Metering pump mount
- 2 Metering pump wiring harness, connector X7 mounted
- 3 Corrugated tube with fuel line and metering pump wiring harness
- 4 10 mm dia. clamp

**Installing metering pump**

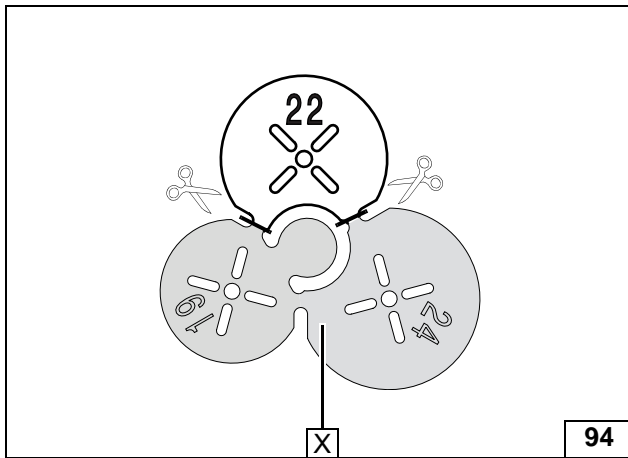

**Installing FuelFix**



X =

**Preparing drilling template**

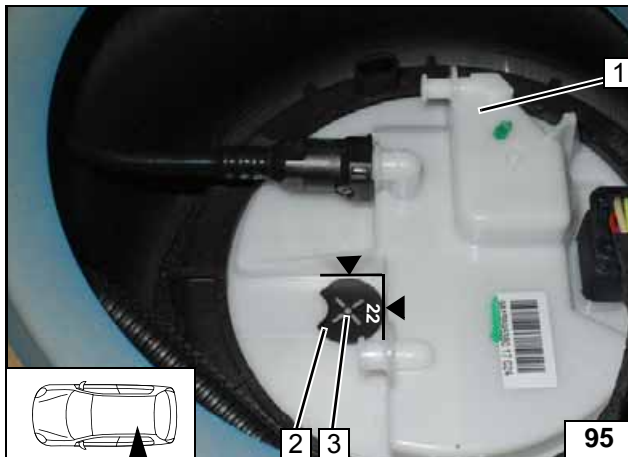

Work steps F1, F2 and F3.

- 1 Fuel tank sending unit
- 2 Position 22mm dia. drilling template as shown
- 3 Hole pattern, hole made with provided drill



**Drilling hole**

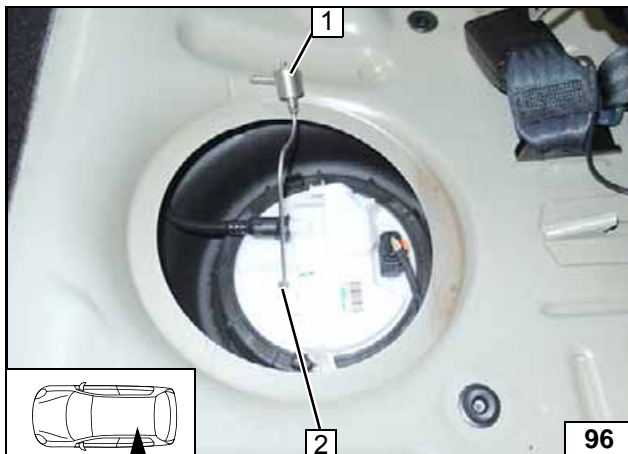

Work steps F4 and F5.

Bend FuelFix 1 according to template and cut to length. Insert into hole 2.



**Inserting FuelFix**

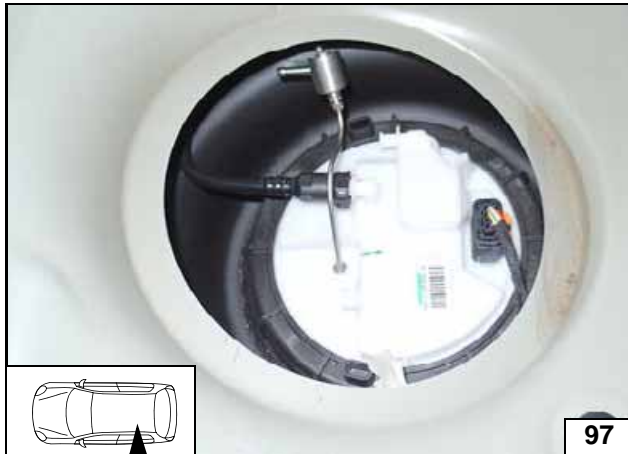

Work step F5.

Inserting  
FuelFix



Inserting  
FuelFix



Inserting  
FuelFix

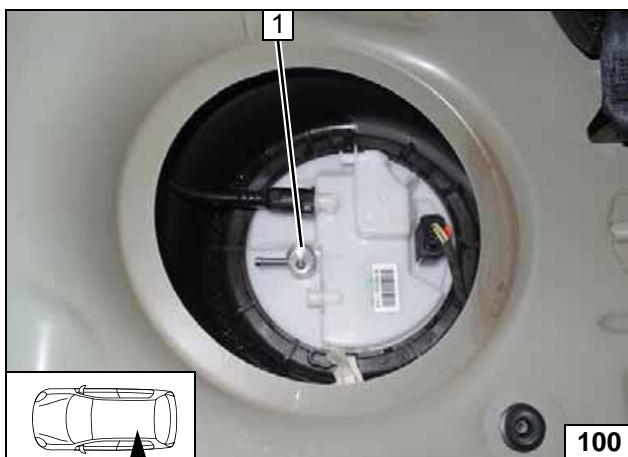

Work steps F5.3 and F5.4.

Align FuelFix 1 as shown.



Aligning  
FuelFix

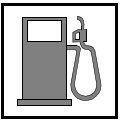

Work step F6.

- 1 Moulded hose, 10 mm dia. clamp [2x]
- 2 Fuel line

Connect-  
ing fuel line

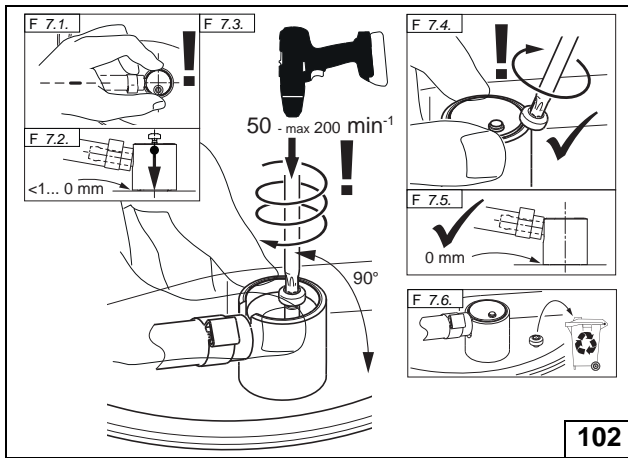

Work step F7.



Installing  
FuelFix

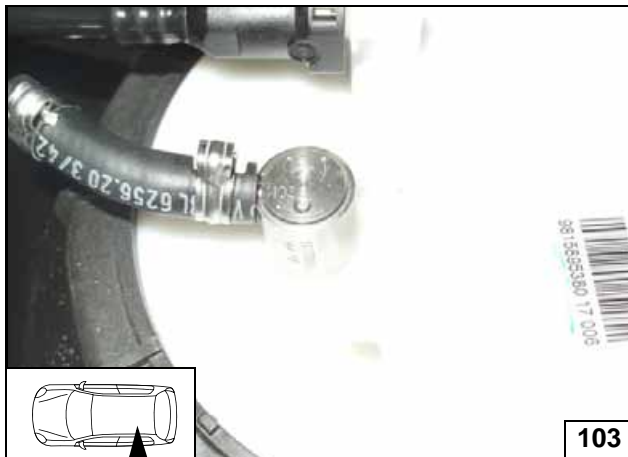

Work step F8.

Ensuring  
firm seating  
of FuelFix

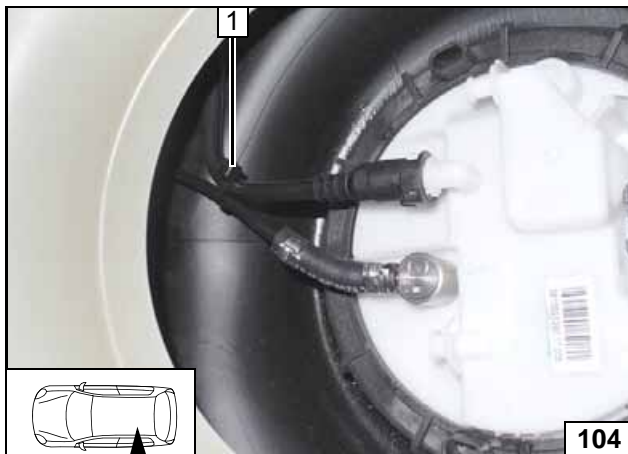

- 1 Cable tie as tension relief

Securing  
fuel line

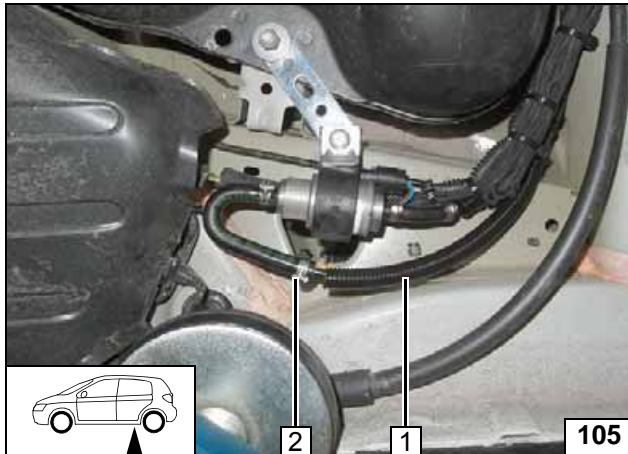
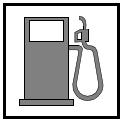

Ensure sufficient distance from neighbouring components, correct if necessary.



- 1 Fuel line in corrugated tube
- 2 10 mm dia. clamp

**Connect-  
ing meter-  
ing pump**

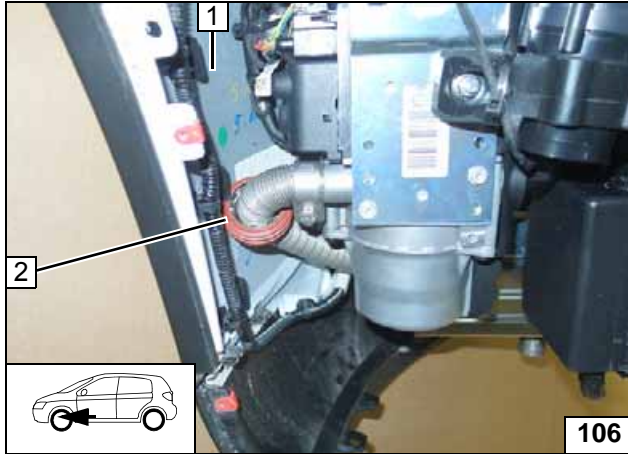
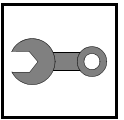

**Final Work**

Install bumper 1.

- 2 Spacer bracket



**Aligning spacer bracket**

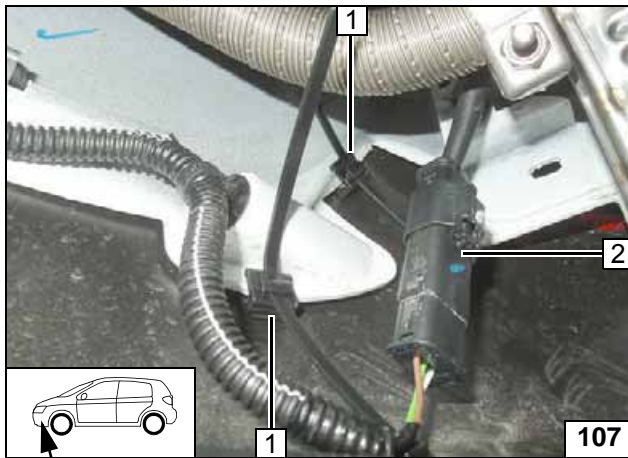

Produce connection with original vehicle connector 2.

- 1 Edge clip cable tie [2x]



**Securing edge clip cable tie**

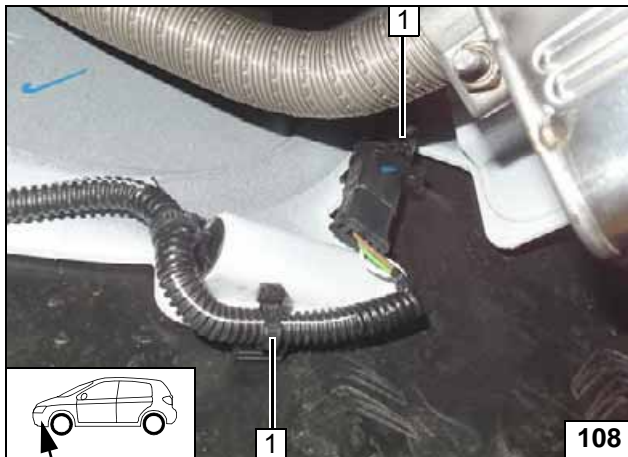

Close edge clip cable tie 1 [2x].



**Installing original vehicle connector**

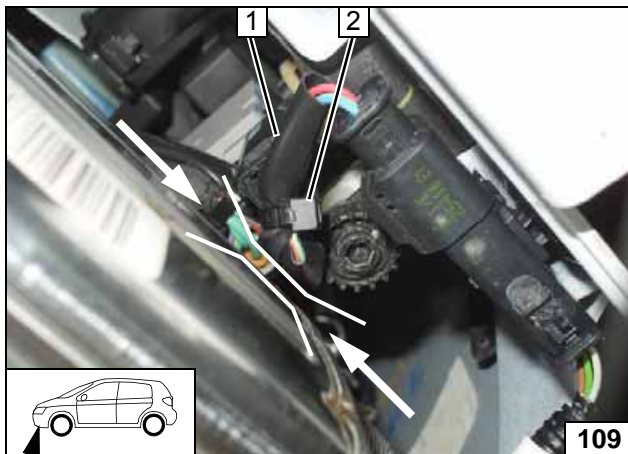

- 1 Original vehicle wiring harness
- 2 Cable tie

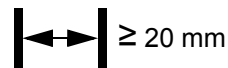

**Securing original vehicle wiring harness**



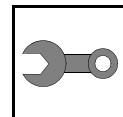

Reassemble the components in reverse order. Check all hoses, clamps and all electrical connections for firm seating. Insulate and tie back loose lines. Only use manufacturer-approved coolant. Spray the heater components with anti-corrosion wax (Tectyl 100K).

- **Connect the battery.**
- **Fill and bleed the coolant circuit according to the vehicle manufacturer's instructions.**
- **Program MultiControl CAR, teach Telestart transmitter.**
- **For initial start-up and function check, please see installation instructions.**
- **Make settings on the A/C control panel according to the 'operating instructions'.**
- **Place the 'Switch off parking heater before refuelling' caution label near the filler neck.**

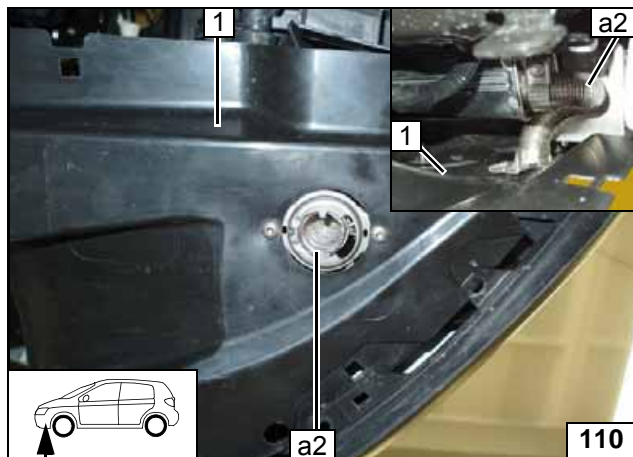

Installing wheel-well inner panel 1.

Work steps E6 - E8.



**Installing  
exhaust  
pipe a2**

Webasto Thermo & Comfort SE  
Postfach 1410  
82199 Gilching  
Germany  
Internet: [www.webasto.com](http://www.webasto.com)  
Technical Extranet:  
<http://dealers.webasto.com>

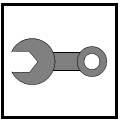

Template for Bracket A

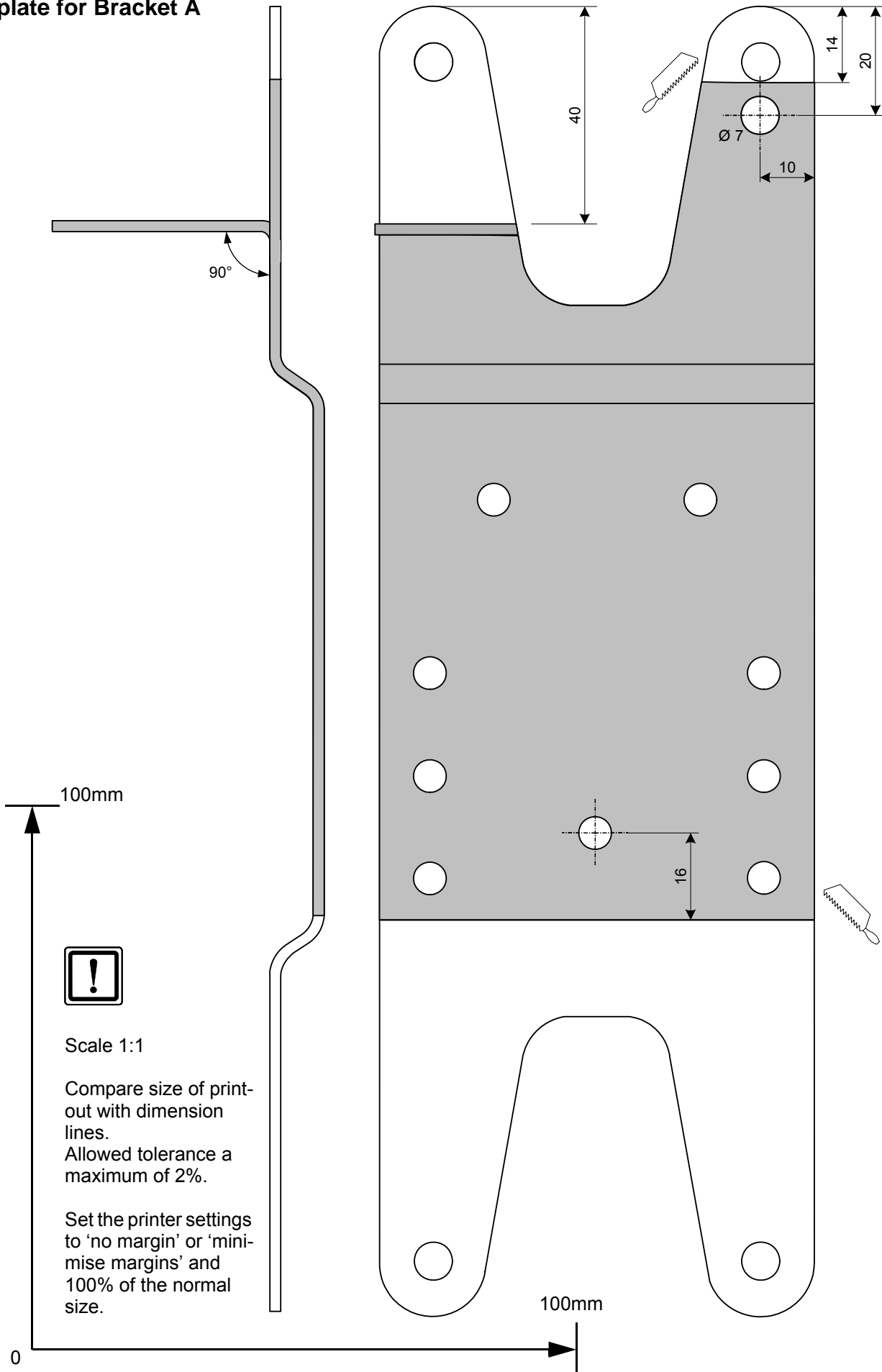

Scale 1:1

Compare size of print-out with dimension lines.  
Allowed tolerance a maximum of 2%.

Set the printer settings to 'no margin' or 'minimise margins' and 100% of the normal size.

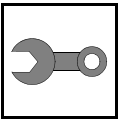

Template for Bracket B

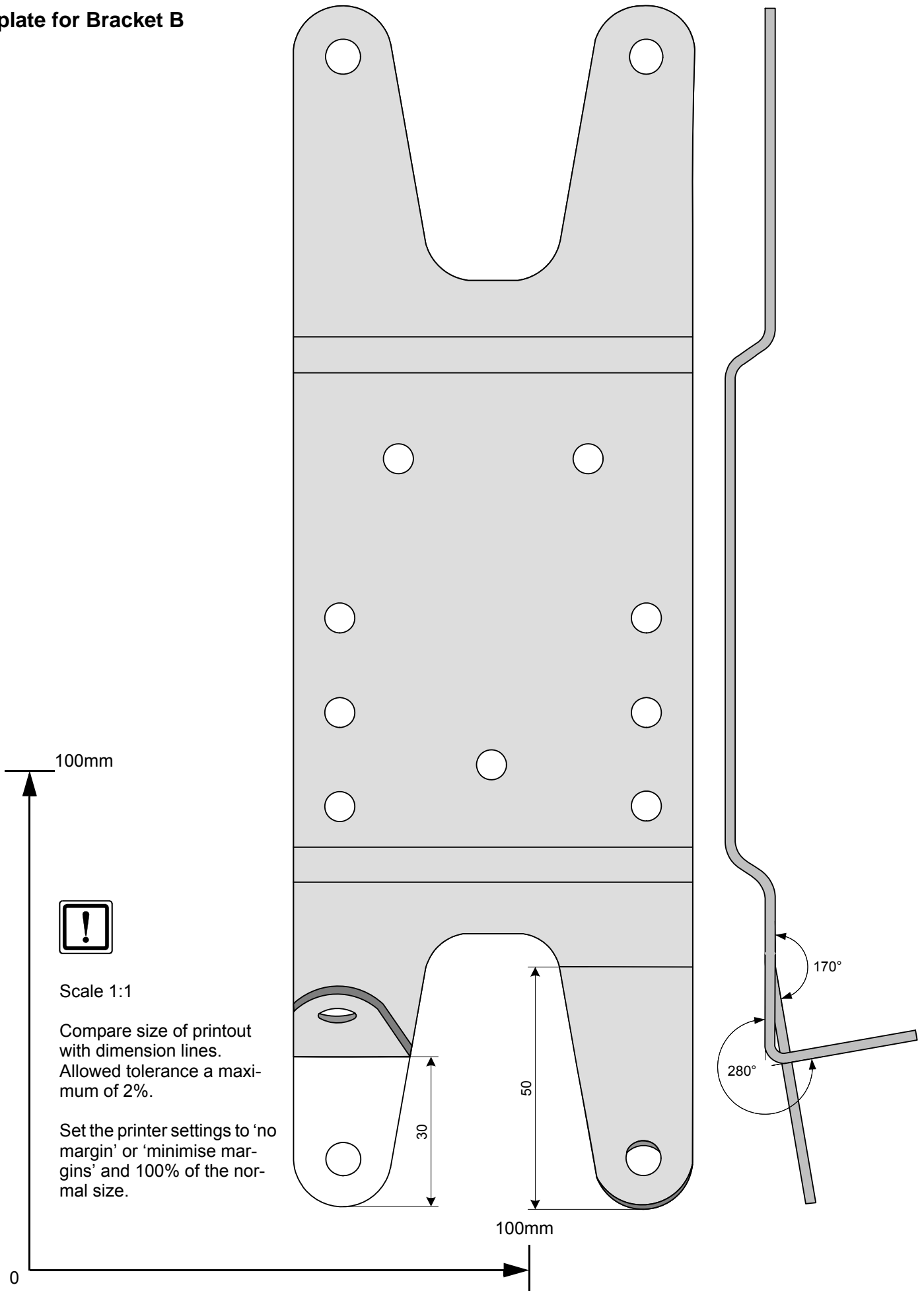

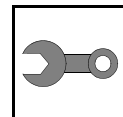

### Installation Location Template

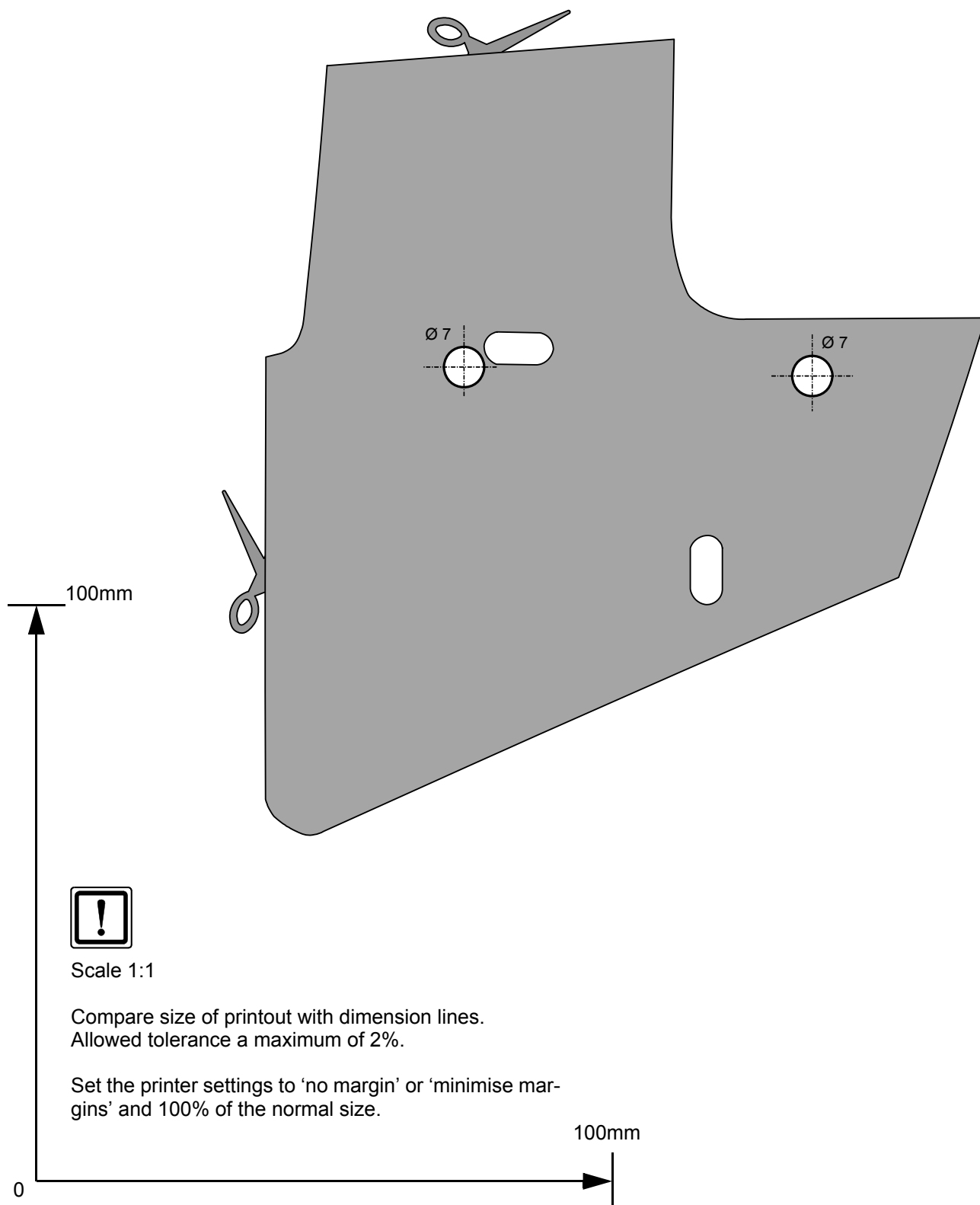

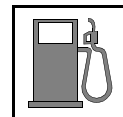

FuelFix Template

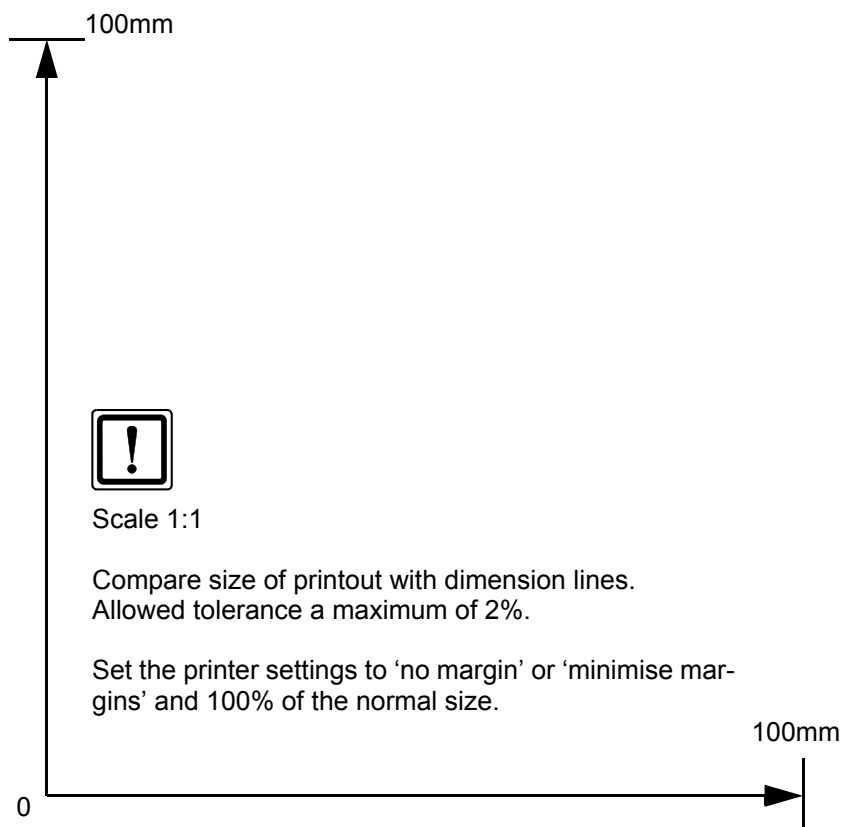
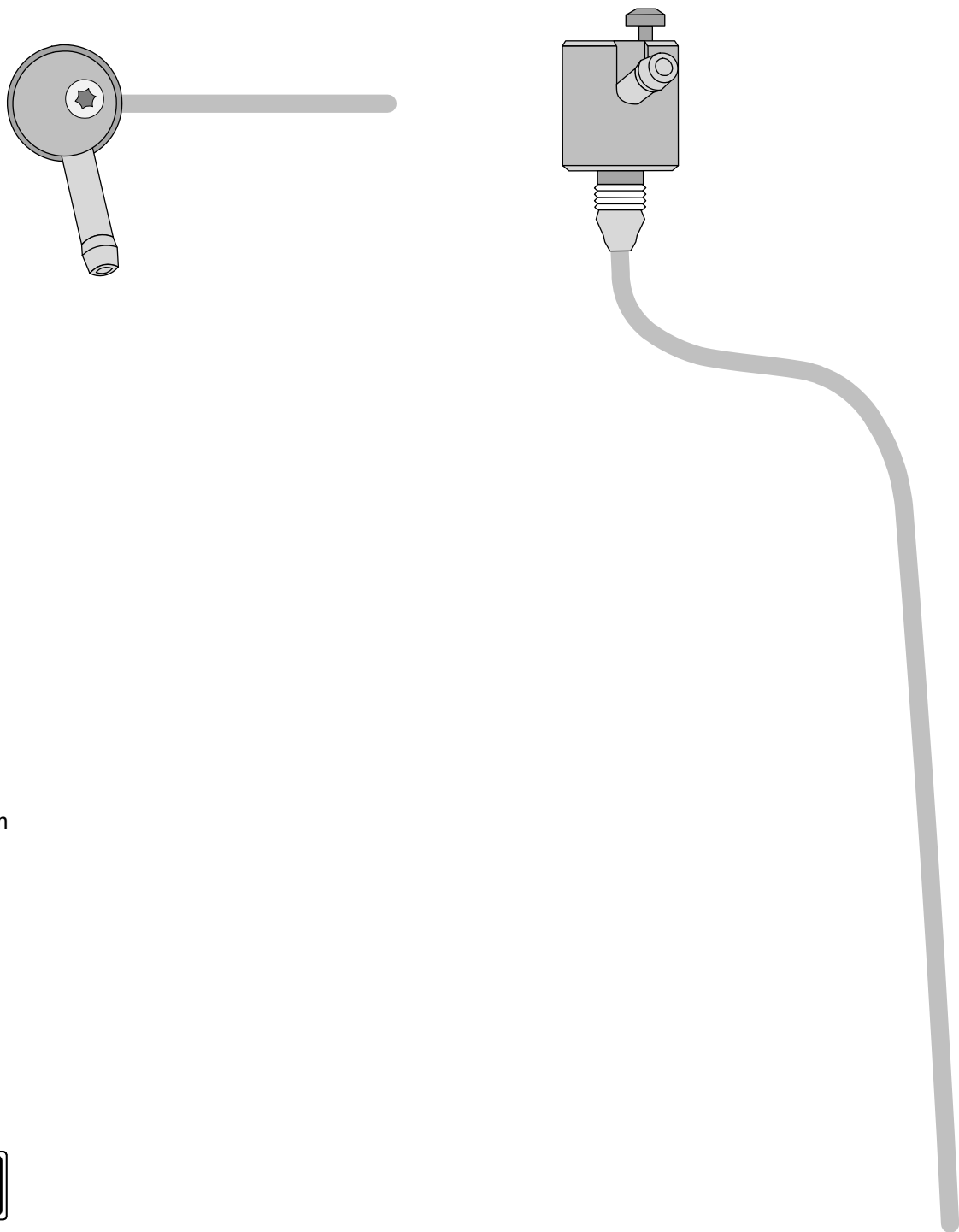

Scale 1:1

Compare size of printout with dimension lines.  
Allowed tolerance a maximum of 2%.

Set the printer settings to 'no margin' or 'minimise margins' and 100% of the normal size.



## Operating Instructions for Manual Air-Conditioning

Please remove page and add to the vehicle operating instructions.

**Note:**

We recommend matching the heating time to the driving time.  
Heating time = driving time

**Example:**

For a driving time of approx. 20 min. (in one direction), we recommend not exceeding a switch-on time of 20 min.

Passenger compartment monitoring, if installed, must be deactivated in addition to the vehicle settings for the heating operation.

For instructions on deactivation, please refer to the operating instructions of the vehicle.

Before parking the vehicle, make the following settings:



It is not necessary to set the fan speed.

- 1 Air outlet to windscreen
- 2 Set temperature to 'max.'

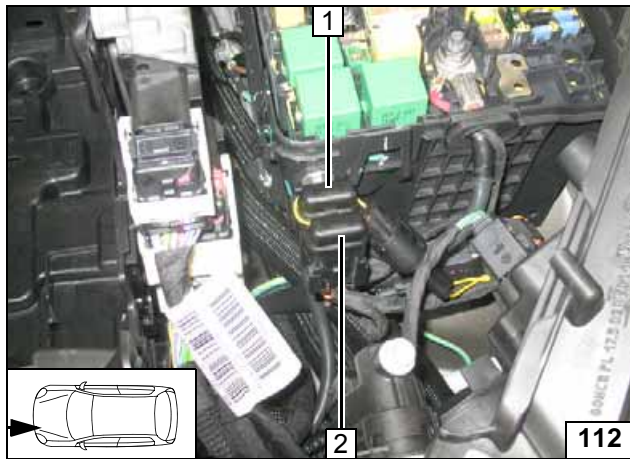

- 1 30A passenger compartment main fuse F2
- 2 20A heater fuse F1

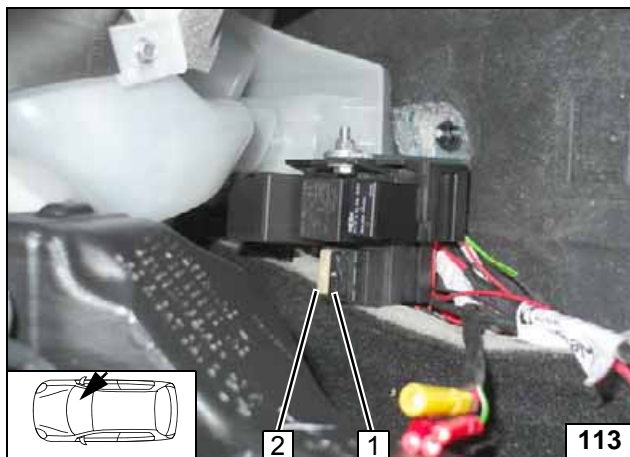

- 1 1A heater control fuse F3
- 2 25A fan fuse F4



A/C control panel

Engine compartment fuses

Passenger compartment fuses

## Operating Instructions for Automatic A/C

Please remove page and add to the vehicle operating instructions.

**Note:**

We recommend matching the heating time to the driving time.  
Heating time = driving time

**Example:**

For a driving time of approx. 20 min. (in one direction), we recommend not exceeding a switch-on time of 20 min.

Passenger compartment monitoring, if installed, must be deactivated in addition to the vehicle settings for the heating operation.

For instructions on deactivation, please refer to the operating instructions of the vehicle.

Before parking the vehicle, make the following settings:



It is not necessary to set the fan speed.

- 1 Set temperature to 'HI'
- 2 Air outlet to windscreen

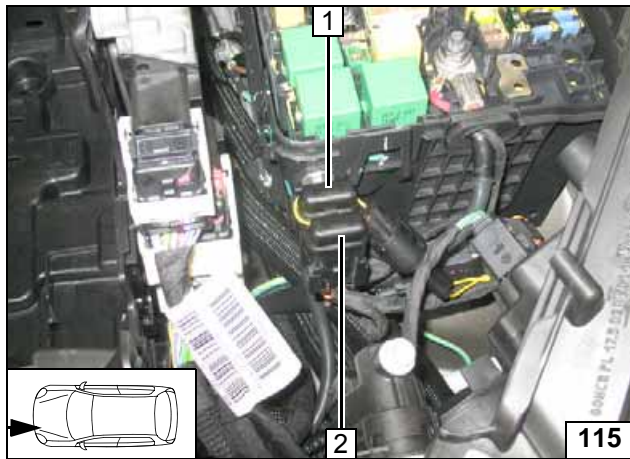

- 1 30A passenger compartment main fuse F2
- 2 20A heater fuse F1

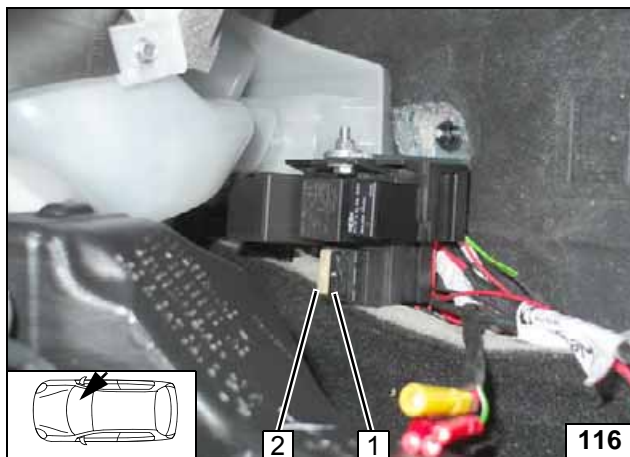

- 1 1A heater control fuse F3
- 2 25A fan fuse F4



**A/C control panel**

**Engine compartment fuses**

**Passenger compartment fuses**

