

# Water Heater unit



Supplementary heating *Thermo Top C* <sup>e1</sup> 00 0002

## Installation instructions

### Dodge Caliber

Diesel

From model year 2007

For left-hand drive vehicles only



#### **WARNING!**

Hazard warning:

Incorrect installation or repair of Webasto heating systems may cause a fire or result in the emission of carbon monoxide, which can be fatal. Serious or fatal injuries can be caused as a result.

Specialist company training, technical documentation, specialized tools and equipment are required to install and repair Webasto heating and cooling systems.

NEVER attempt to install or repair Webasto heating or cooling systems if you have not successfully completed the company training and thereby acquired the required technical skills or if you do not have access to the required technical documentation, tools and equipment needed to carry out correct installation and repairs.

ALWAYS follow all Webasto installation and repair instructions and observe all warning instructions.

Webasto does not accept any liability for defects and damage that are attributable to an installation by untrained staff.

## Table of Contents

|  |   |  |    |
|--|---|--|----|
| Validity                               | 2 | Preparing the Installation Location            | 10 |
| Heater Unit / Installation Kit         | 3 | Preparing the Heater Unit                      | 11 |
| Foreword                               | 3 | Installing the Heater Unit                     | 14 |
| General Instructions                   | 3 | Fuel Connection                                | 15 |
| Special Tools                          | 3 | Exhaust System                                 | 18 |
| Explanatory Notes on the Document      | 4 | Water Connection                               | 20 |
| Preliminary work                       | 5 | Final Work                                     | 22 |
| Heater unit installation location      | 5 | Operating instructions for the end customer    | 23 |
| Electrical Connections                 | 6 | Fastening Strap Template for the Metering Pump | 24 |
| Manual air conditioning blower control | 7 | Tank Extracting Device Template                | 25 |
| Time switch                            | 8 |  |    |
| Summer / winter switch option          | 8 |  |    |
| Remote Start Option                    | 8 |  |    |
| Thermo Call Option                     | 9 |  |    |

## Validity

| Manufacturer           | Model         | Type | EG-BE No. / ABE               |
|------------------------|---------------|------|-------------------------------|
| Daimler Chrysler (USA) | Dodge Caliber | PK   | e11 * 2001 / 116 * 0142 * ... |

| Engine type | Engine model | Power in kW | Engine capacity in cm <sup>3</sup> |
|-------------|--------------|-------------|------------------------------------|
| Code: BYL   | Diesel       | 103         | 1968                               |

Vehicle and engine types, equipment variants as well as national specifications, which are not listed in these installation instructions, have not been tested. Installation according to these installation instructions may, however, be possible.

The installation location of a time switch and summer / winter switch should be confirmed with the end customer before installation.

**Heater Unit / Installation Kit**

| Amount | Description                               | Order no.: |
|--------|---|------------|
| 1      | LU Thermo Top C (D) with time switch      | 89244D     |
| 1      | LU Thermo Top C (D) with T80 remote start | 9007165A   |
| 1      | Installation kit for Dodge Caliber Diesel | 1311554A   |

**Foreword**

These installation instructions apply to Dodge vehicles with Caliber Diesel – validity, see page 2 – from model year 2007 and later, assuming technical modifications to the vehicle do not affect installation, any liability claims excluded. Depending on the vehicle version and equipment, modifications may be necessary during installation with respect to these installation instructions.

However, where this is the case the stipulations in the "installation instructions" and "operating and maintenance instructions" for the *Thermo Top C* should be observed.

The corresponding rules of technology and any information from the vehicle manufacturer should be observed during the installation work.

**General Instructions**

Installation should be carried out according to the general, standard rules of technology. Unless specified otherwise, fasten hoses, lines and cable harnesses to original vehicle lines and cable harnesses using cable clips.

Sharp edges should be fitted with edge protectors (split open plastic hose).

Spray unfinished body areas, such as bore holes, with anti-corrosion wax (Tectyl 100K, Order no. 111329).

**Special Tools**

- Torque spanner for 2.0 - 10 Nm
- Vice-grip wrench
- Special Chrysler tool no: 9340

**Explanatory Notes on the Document**

To provide you with a quick overview of the individual working steps, you will find an identification mark on the outside top right corner of the page in question.

**Mechanics**

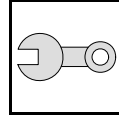

**Electrics**

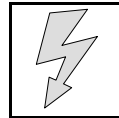

**Water connection**

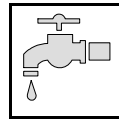

**Fuel connection**

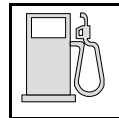

**Exhaust System**

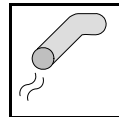

**Combustion air**

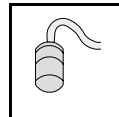

Special features are highlighted using the following symbols:



Specific risk of injury or fatal accidents.



Specific risk of damage to components.



Specific risk of fire or explosion.



Reference to general installation instructions of Webasto components or to the manufacturer's vehicle-specific documents.



Reference to a special technical feature.

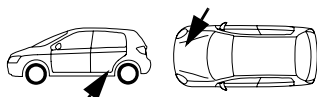

The arrow in the vehicle icon indicates the position on the vehicle and the viewing angle.

**Preliminary work**

**WARNING!**

- Open the tank cap, ventilate the tank.
- Close the tank cap again.
- Disconnect the battery.
- Pressure in the cooling system!
- Copy the factory number from the original type label to the duplicate type label.
- Remove years that do not apply from the duplicate label.
- Attach the duplicate label (type label) in the appropriate place.
- Remove the motor cover.
- Remove air filter and suction tube
- Remove the front left wheel-house panel
- Remove the engine underride protection.
- Remove the rear left underride protection
- Remove the rear seat bench.
- Open the left tank mounting service lid
- Remove tank mounting according to manufacturer's instructions.
- Remove the dashboard panel on the driver's side.
- Remove the steering column panel on the driver's side.

Remove page 23 "Operating instructions for the end customer" and insert with vehicle operating instructions.

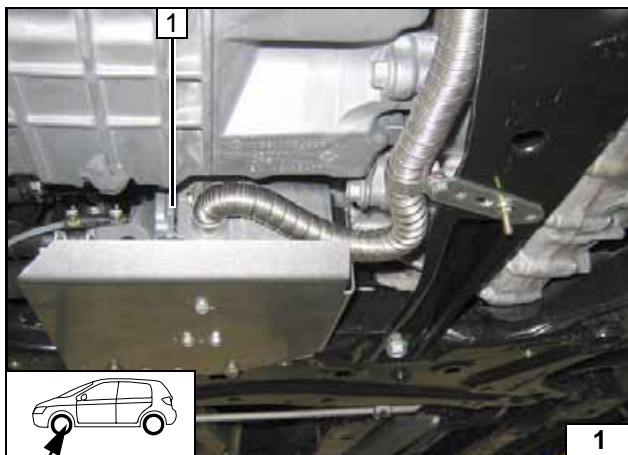

**Heater unit installation location**

- 1 Heater unit

**Installation location**



## Electrical Connections

### Connecting the ground wire

- 1 Chassis ground point
- 2 Ground wire

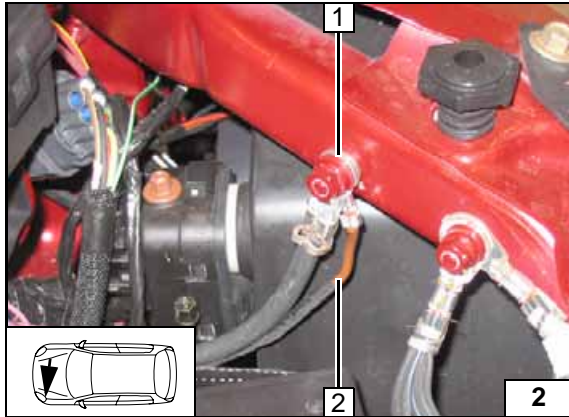

### Installing the heater unit cable harness

- 1 Heater unit cable harness to original vehicle lines

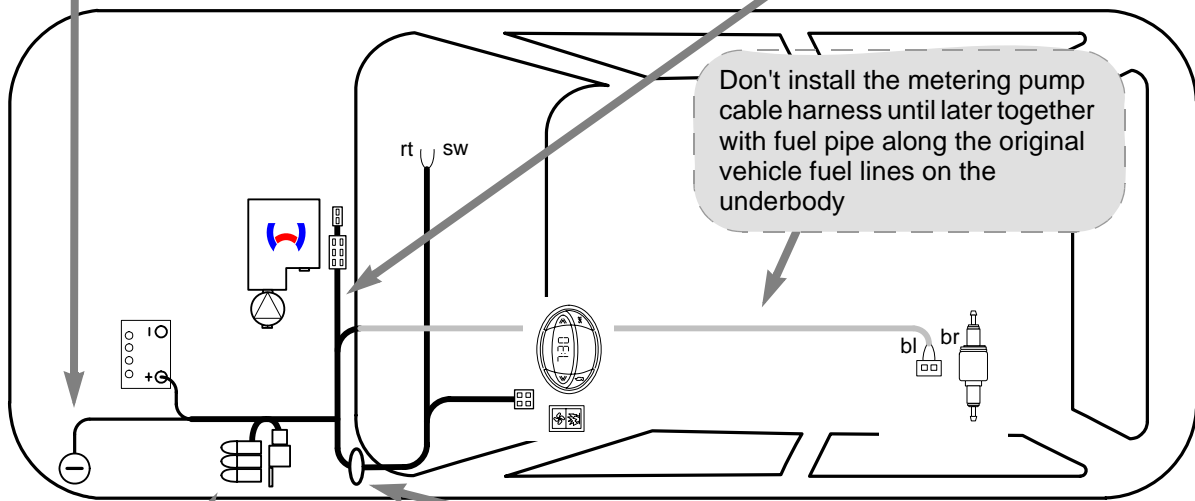
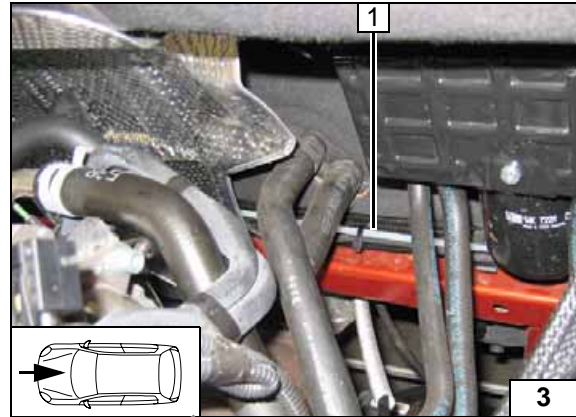

Cable harness installation diagram

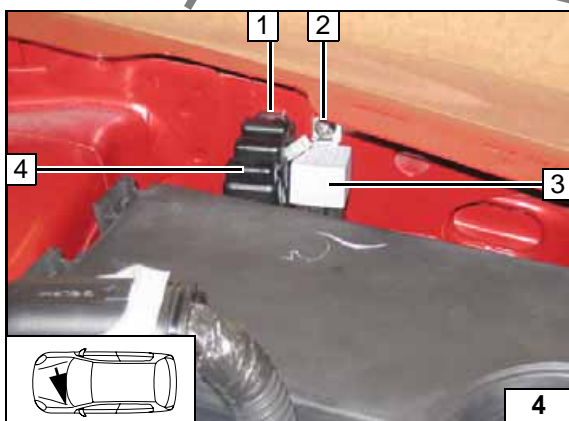

### Fuse holder, K3 relay

- 1 Fuse holder retaining plate, bore hole  
Ø 4mm, 5.5x13 self-tapping screw
- 2 Ø 4mm bore hole, 5.5x13 self-tapping screw
- 3 K3 relay
- 4 Fuse holder

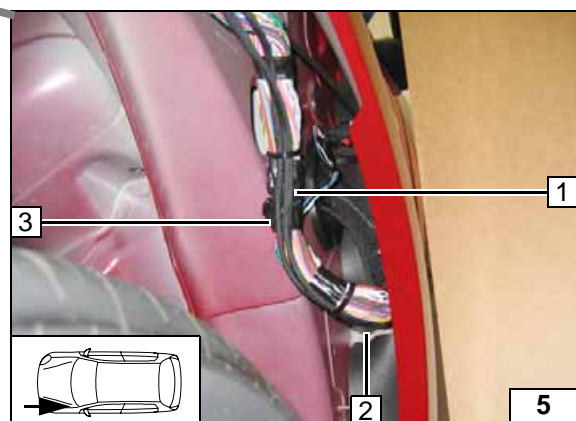

### Cable harness feed-through

Extend the blower cable harness in the interior with the enclosed wires of the same color!

- 1 Blower control cable harness
- 2 Original vehicle protective rubber sleeve
- 3 Time switch cable harness



Manual air conditioning blower control

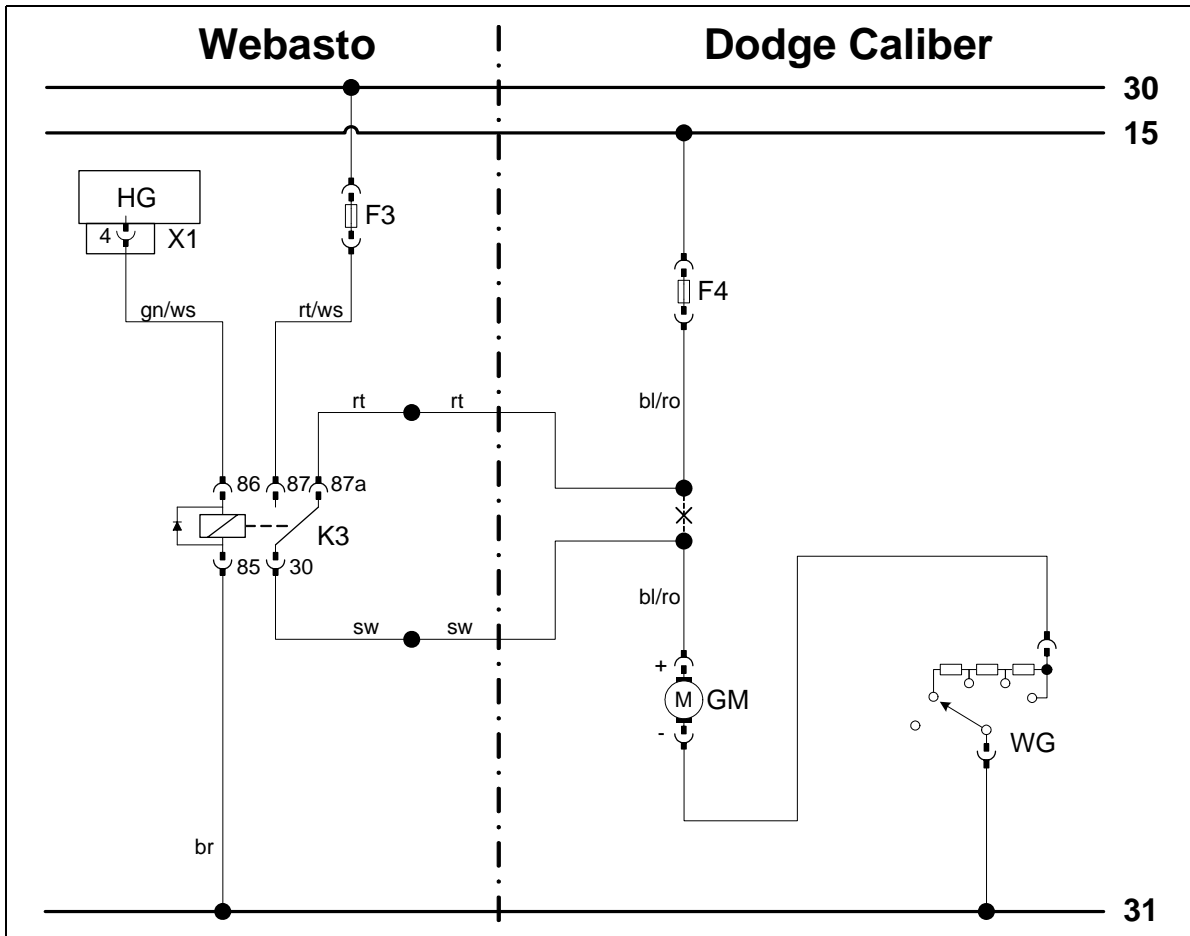

Circuit diagram

| Webasto components |                    | Vehicle components |                | Colors and symbols     |                 |
|--------------------|--------------------|--------------------|----------------|------------------------|-----------------|
| HG                 | Heater unit TT-C/E | GM                 | Blower motor   | rt                     | red             |
| X1                 | 6-pin connector    | WG                 | Resistor group | ws                     | white           |
| F3                 | Fuse 25A           | F4                 | Blower fuse    | sw                     | black           |
| K3                 | Blower relay       |                    |                | br                     | brown           |
|                    |                    |                    |                | gn                     | green           |
|                    |                    |                    |                | bl                     | blue            |
|                    |                    |                    |                | ro                     | pink            |
|                    |                    |                    |                | X                      | Splitting point |
|                    |                    |                    |                | Cable colors may vary. |                 |

Legend

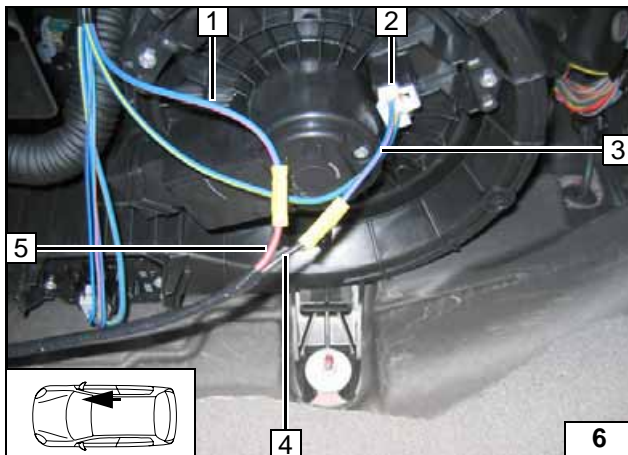

Connection to 2-pin connector 2 from the blower motor.  
Reconnect according to the circuit diagram.

- 1 Blue/pink (bl/ro) wire from blower fuse
- 3 Blue/pink (bl/ro) wire to 2 pin connector
- 4 Black (sw) wire from relay K3/30
- 5 Red (rt) wire to relay K3/87a



Connecting the blower motor

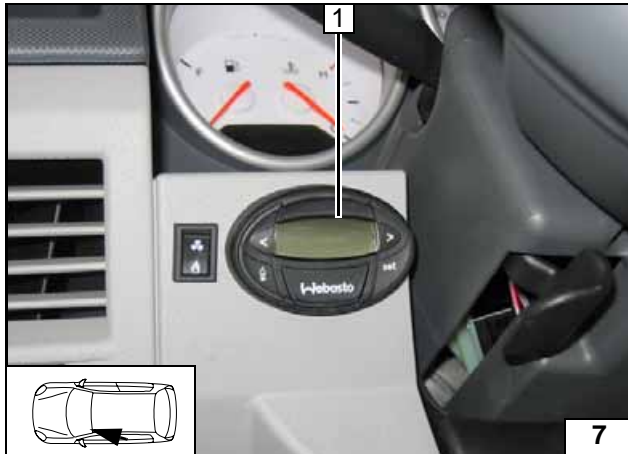

**Time switch**

- 1 Time switch

Assembling the time switch

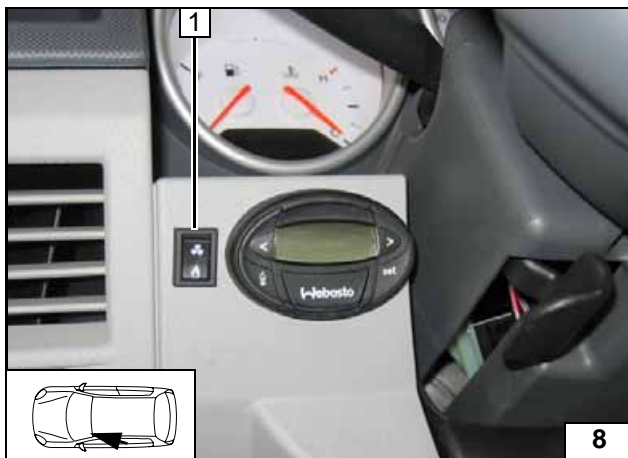

**Summer / winter switch option**

- 1 Bore hole Ø 12 mm, summer / winter switch

Assembling the summer / winter switch

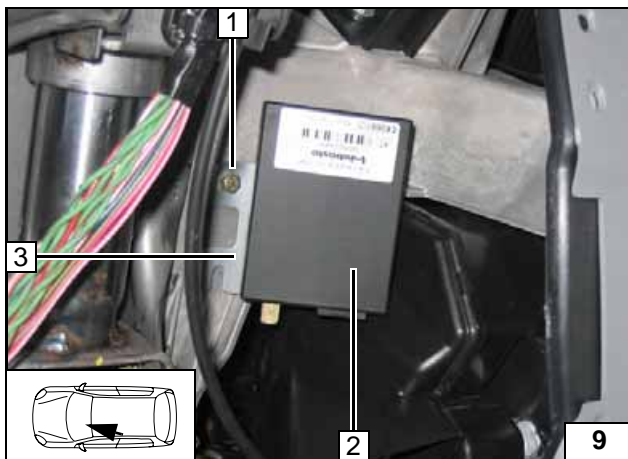

**Remote Start Option**

Position the bracket 3 according to the illustration.

- 1 Bolt M5x16, M5 flanged nut in previously drilled hole
- 2 Receiver (to the right next to the steering column)



Assembling the receiver

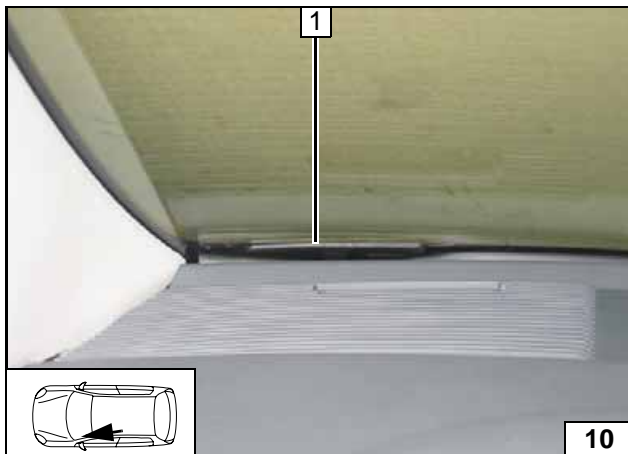

- 1 Antenna

Assembling the antenna



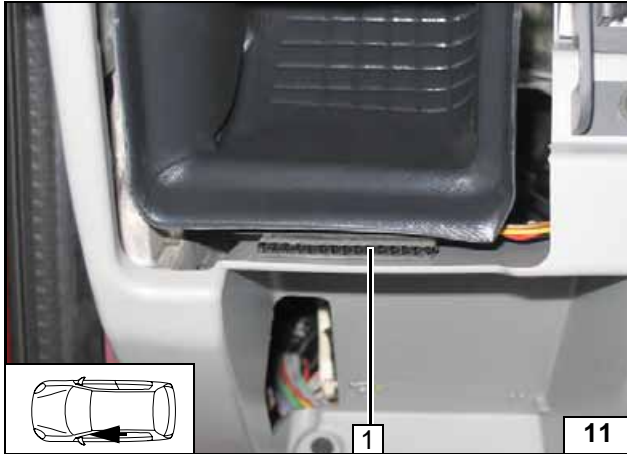

**Temperature sensor for HTM100 only**

- 1 Temperature sensor, fasten as appropriate

Assembling the temperature sensor

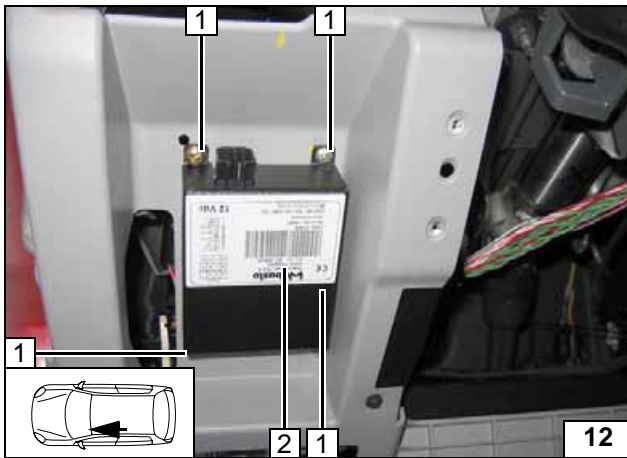

**Thermo Call Option**

- 1 Ø 4mm bore hole, 5.5x13 self-tapping screws [4x each]
- 2 Receiver (to the left next to the steering column)



Assembling the receiver

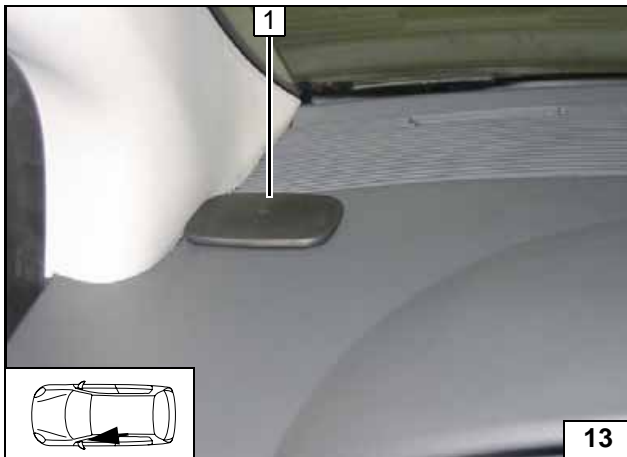

- 1 Antenna

Assembling the antenna

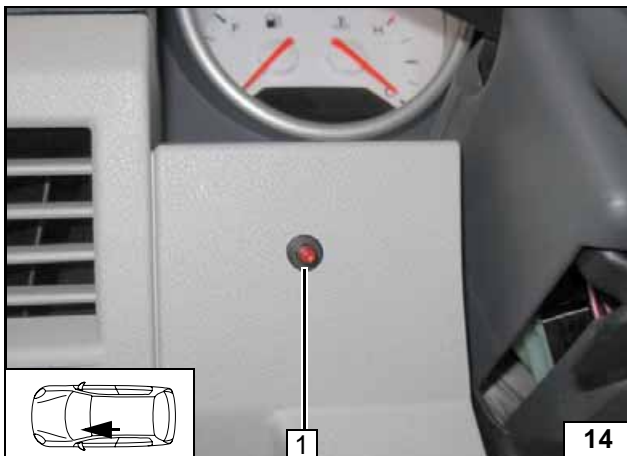

- 1 Tip switch

Assembling the tip switch

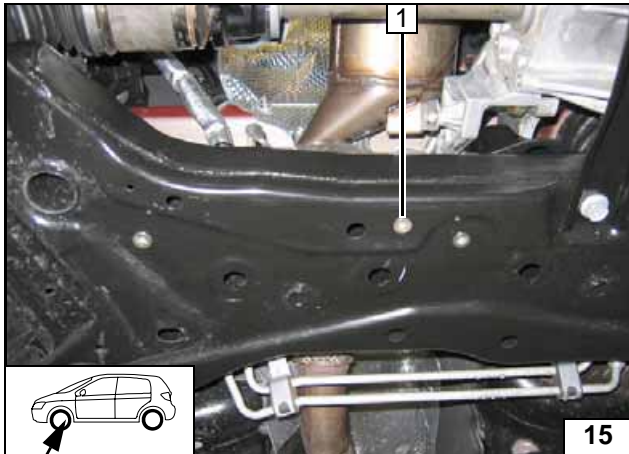
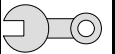

**Preparing the Installation Location**

1 Rivet nut M8 in available bore hole

Inserting rivet nuts

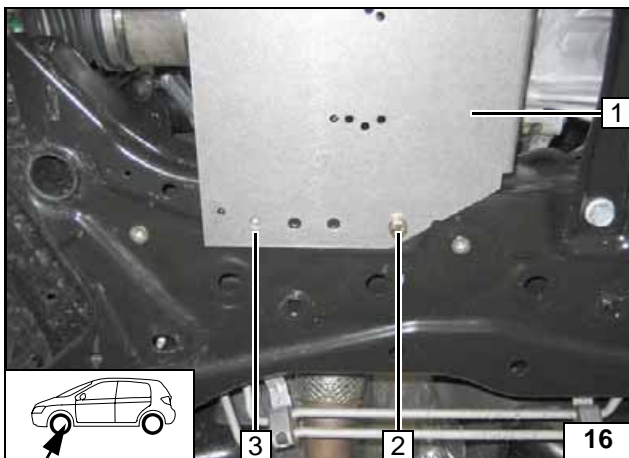

Loosely pre-assemble the bracket 1 and with bolt M8x30 2 on the rivet nut.

3 Copy the hole image



Copy the hole image

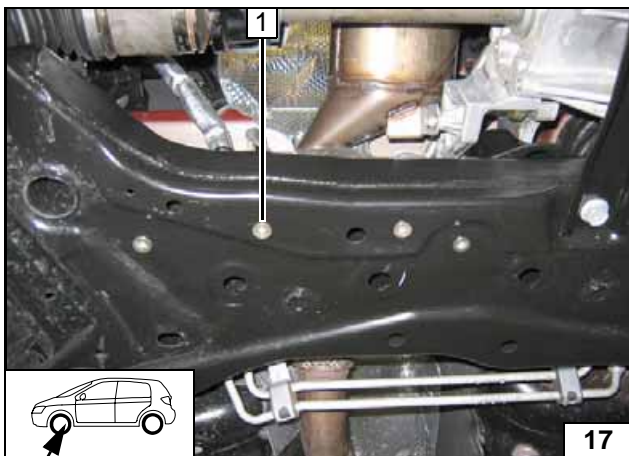

Remove the bracket

1 Ø 12.5mm bore hole, tighten M8 rivet nut



Inserting rivet nuts

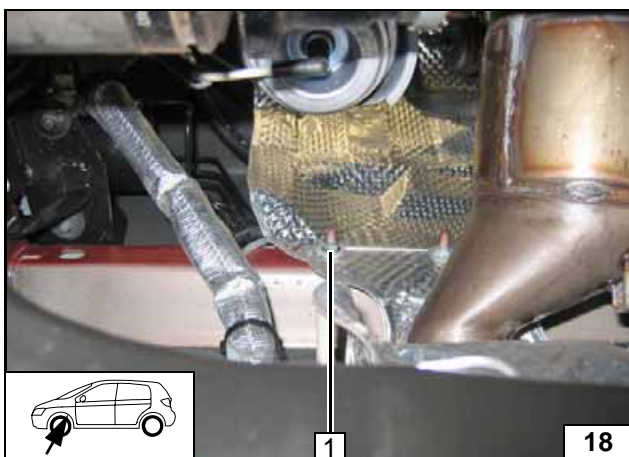

Replace metal nut with the body washer and M6 flanged nut at position 1.



Replace nut

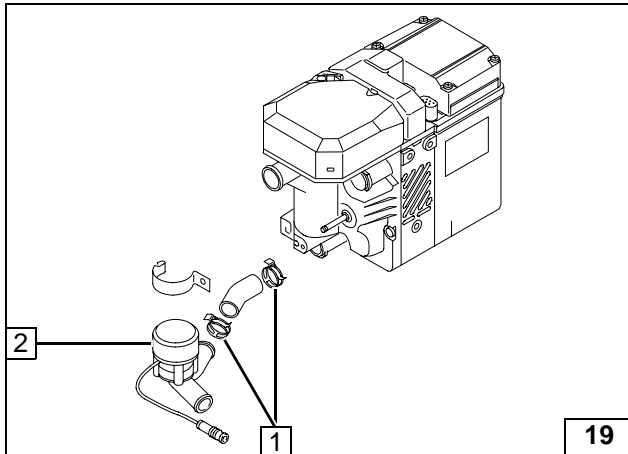
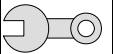

**Preparing the Heater Unit**

Disassemble the circulation pump 2, the spring band clamps 1 [2x] will be used again.



**Disassemble the circulation pump**

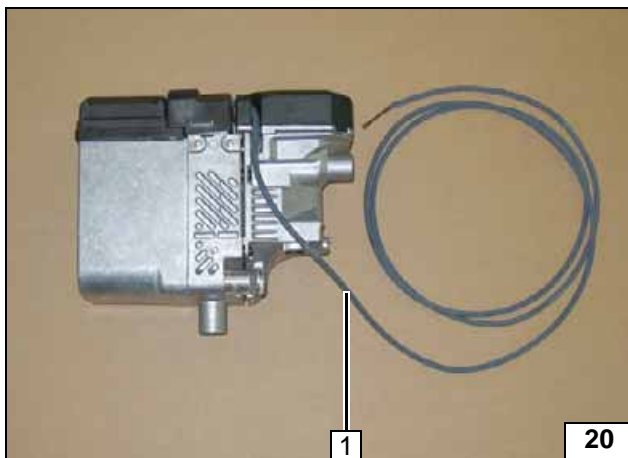

1 Extension for the circulation pump cable harness

**Slide on cable harness**

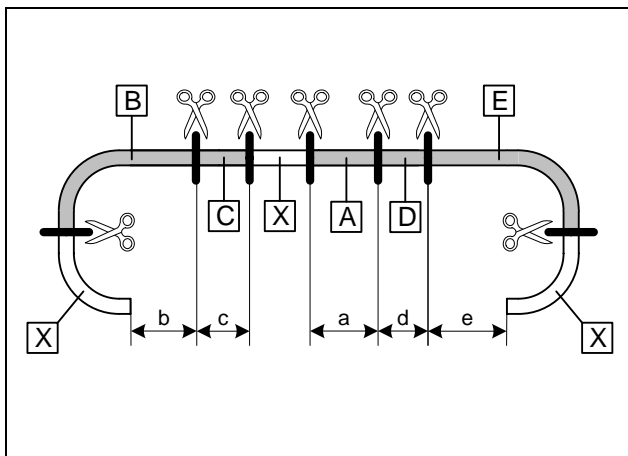

- a = 350mm
- b = 350mm
- c = 90mm
- d = 80mm
- e = 620mm

Dispose of section X

**Cutting water hoses into sections**

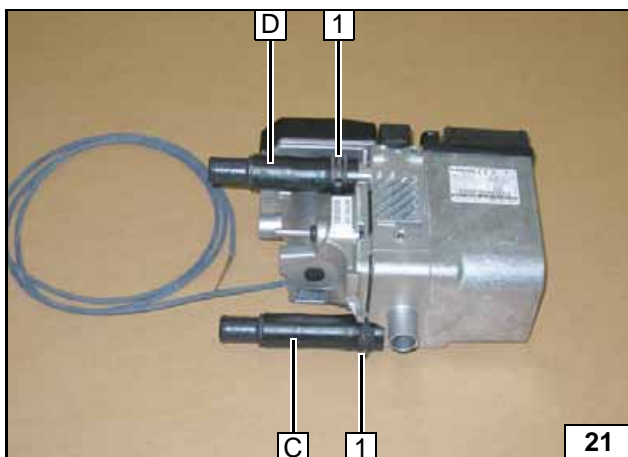

1 Spring band clamp [2x], from circulation pump

**Assemble hose C and D**

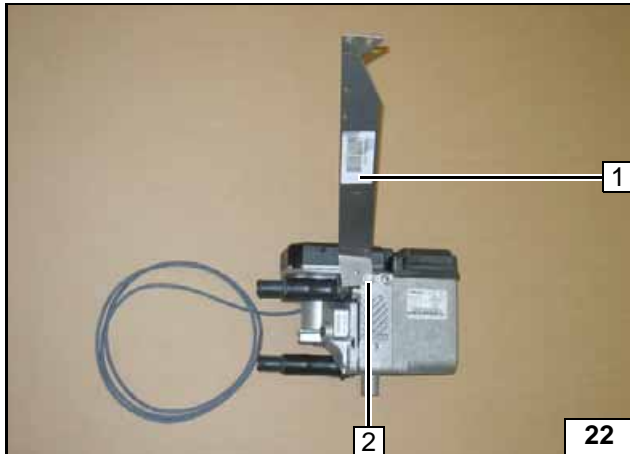
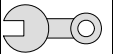

- 1 Strut
- 2 Loosely pre-fit ejet screw bolt

Loosely preassemble the strut on the heater unit

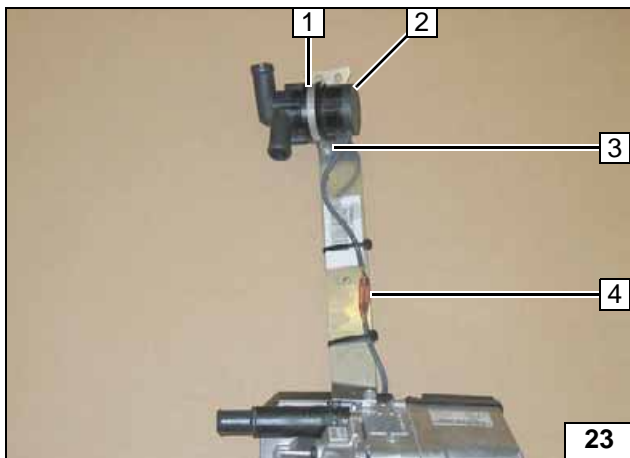

Connect the circulation pump cable harness and the extension with the butt connectors 4 of the same color.



- 1 Rubberized tube clamp Ø 48mm
- 2 Circulation pump
- 3 M6x20 bolt, flanged nut M6 on strut

Pre-assembling the circulation pump on the strut

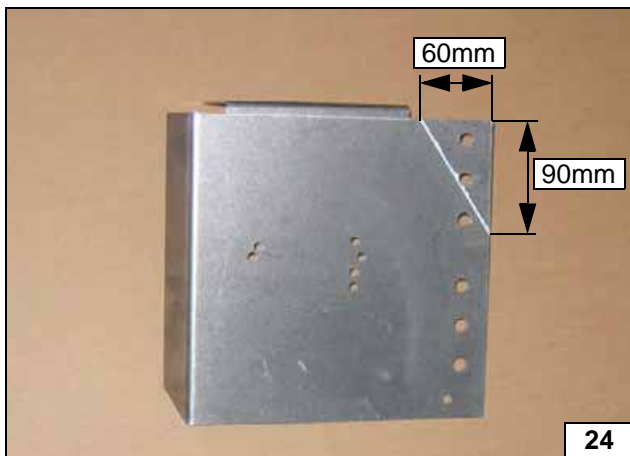

Cut bracket to size

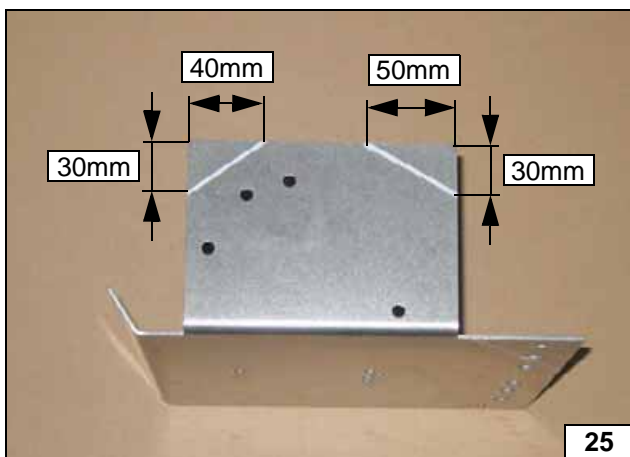

Cut bracket to size

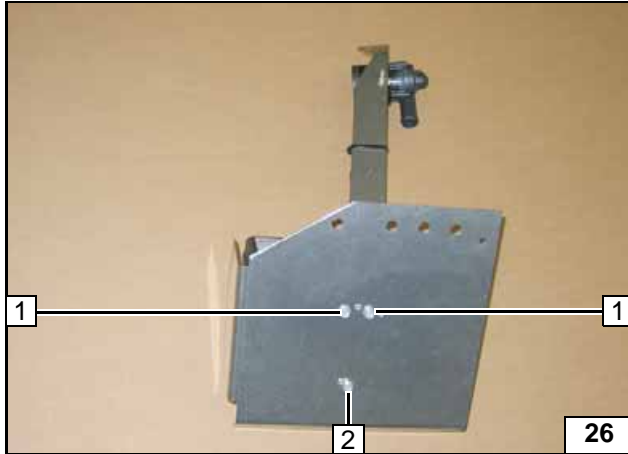
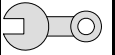

E-jot screw bolt tightening torque 10 Nm!  
Insert two washers between the heater unit and the bracket in position 2.

- 1 E-jot screw bolt [2x]
- 2 E-jot screw bolt, washer [2x]



**Pre-assembling the bracket on the heater unit**

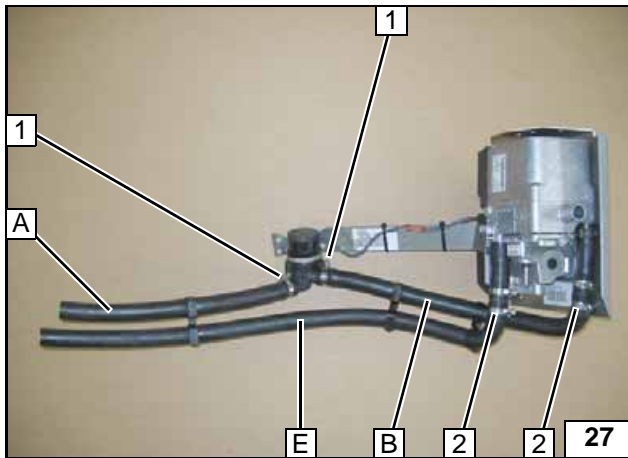

- 1 Ø 27mm hose clamps [2x]
- 2 Connecting pipe 20x20 [2x], Ø 27mm hose clamps [4x]

**Pre-assemble the water hose on the heater unit**

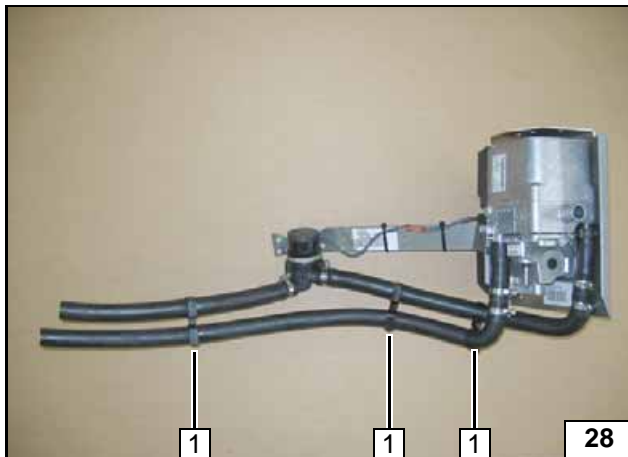

- 1 Spacer brackets [3x]

**Inserting spacer bracket**

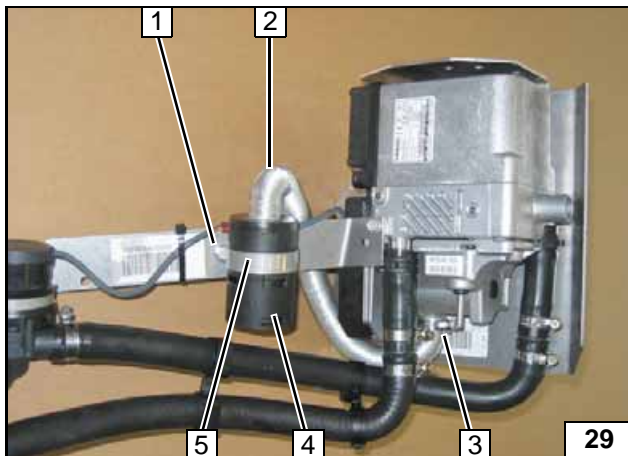

- 1 M6x20 bolt, flanged nut M6 on strut
- 2 Combustion air pipe
- 3 Ø 27 mm hose clamp
- 4 Combustion air intake silencer
- 5 Ø 52mm tube clamp

**Pre-assembling the fuel pipe**

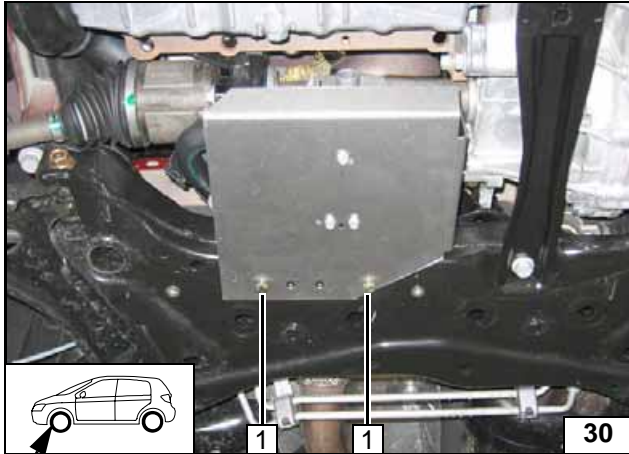
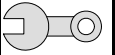

**Installing the Heater Unit**



Prior to assembly, put on the heater unit cable harness

- 1 M8x30 bolt, spring washer, washer [2x each] on prepared rivet nuts

**Assembling the Heater Unit**

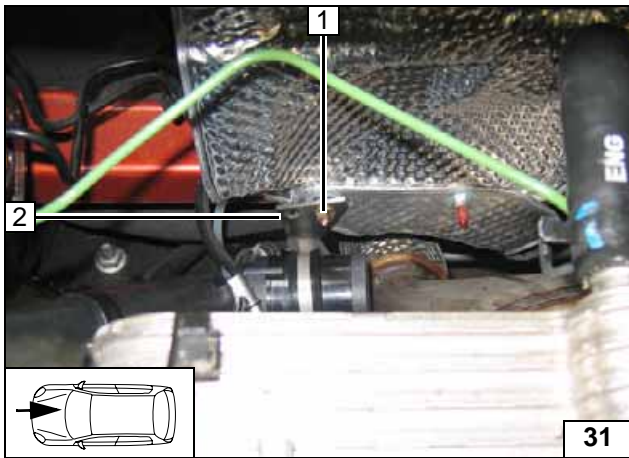

- 1 M6 flanged nut to original vehicle stay bolts
- 2 Strut

**Assembling the Heater Unit**



**Fuel Connection**

**CAUTION!**

Open the vehicle's tank-cap lock, ventilate the tank and then re-close the tank lock.

Catch any fuel running off with an appropriate container.

Install fuel line and metering pump cable harness so that they are protected against stone impact. Unless specified otherwise, always fasten using cable clips! Fit the fuel line and cable harness with edge protectors around sharp edges.

**WARNING!**

The fuel line and cable harness to the metering pump should be installed based on the cable harness installation diagram.

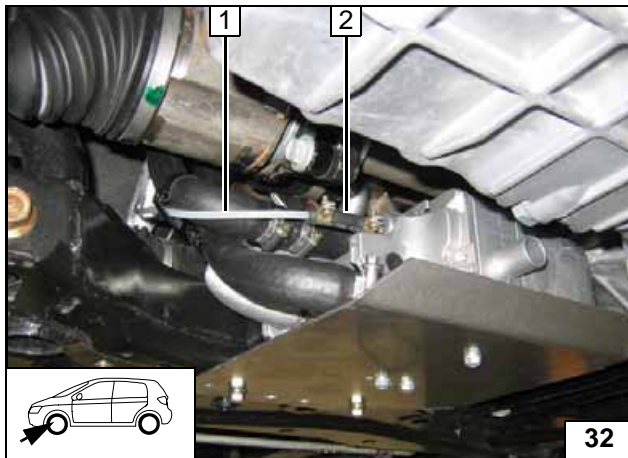

- 2 Fuel line
- 1 Hose section, Ø 10 mm hose clamps [2x]

Connection to heater

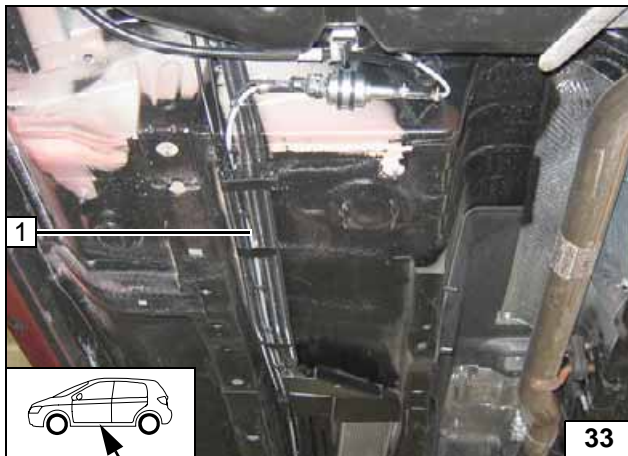

- 1 Mecanyl fuel pipe, metering pump cable harness to original vehicle wires

Installing lines

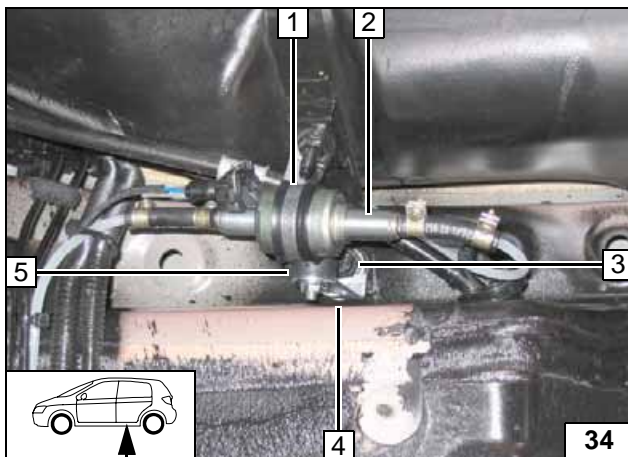

Note the installation position of the metering pump **2**, see the "Installation Instructions". The installation location is on the left before the vehicle tank.

Drill and bend the fastening strap **4** according to the template

- 1 Rubberized tube clamp
- 3 Original vehicle bolt
- 5 Silent block, flanged nut [2x]



Metering pump installation location

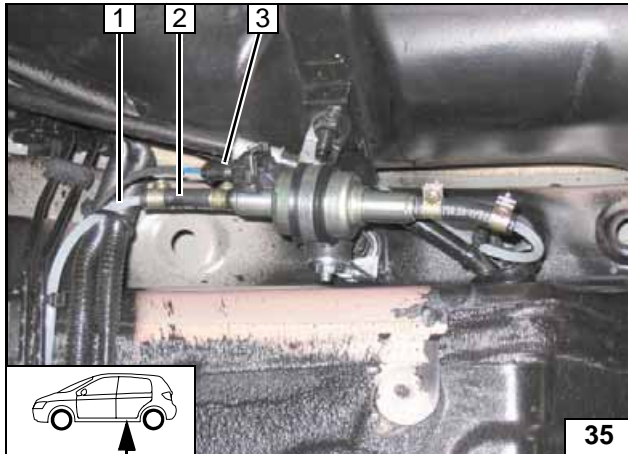

Fuel line from the heater unit **1** on the pressure side of the metering pump [side with connector].

- 2** Hose section, Ø 10 mm hose clamps [2x].
- 3** Metering pump cable harness, single wire seals [2x], flat connector [2x], connector housing



**Connecting to metering pump**

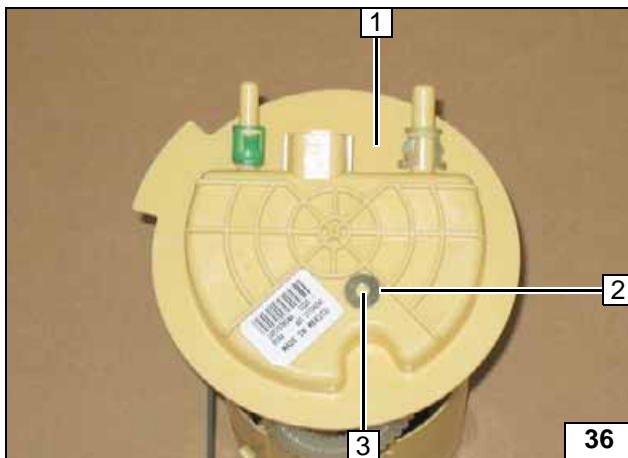

Remove tank mounting according to manufacturer's instructions.

- 1** Tank mounting
- 2** Position Ø 16.7mm body washer according to the illustration
- 3** Copy the hole image, Ø 6mm bore hole



**Fuel take-off**



Shape, cut into sections, and insert the tank extracting device **1** according to the template, see the Installation Instructions.



**Inserting tank extracting device**

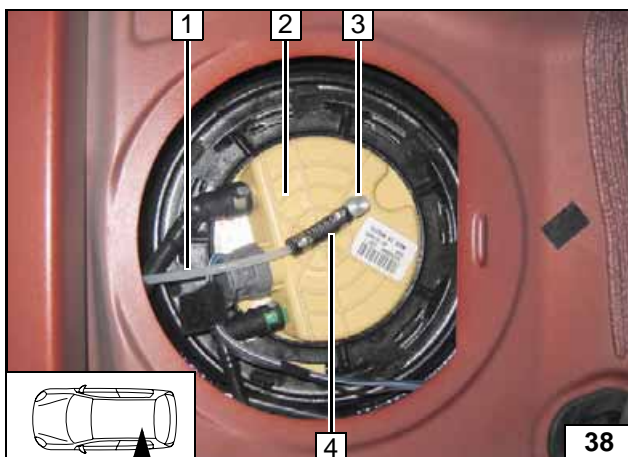

Install the tank mounting **2** according to the manufacturer's instructions.

- 1** Residual section of fuel line
- 3** Tank extracting device
- 4** Hose section, Ø 10 mm hose clamps [2x]



**Connecting and disconnecting the fuel pipe**



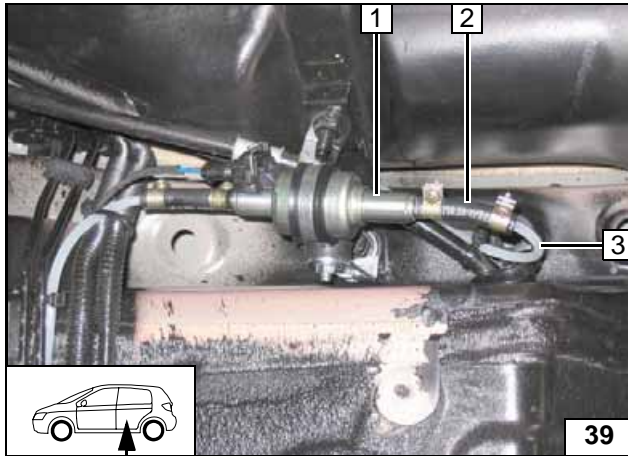

Fuel line from the tank extracting device **3** on the intake side of the metering pump **1** [side without connector].

Check the position of the components; adjust if necessary. Check that they have free clearance.

**2** Hose section, Ø 10 mm hose clamps [2x].



**Con-  
nection to  
metering  
pump**

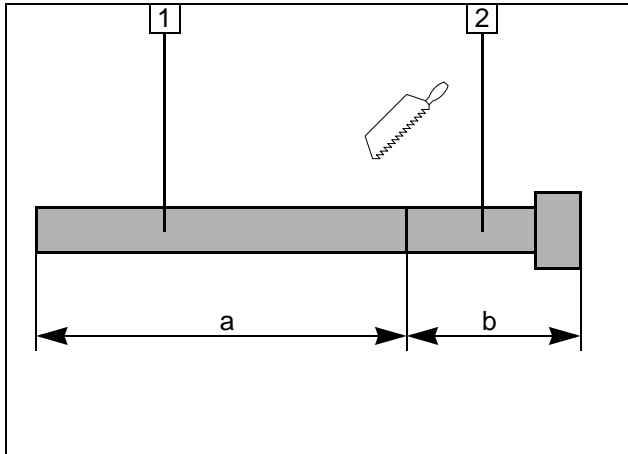
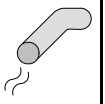

### Exhaust System

- 1 Exhaust pipe  
a = 820mm
- 2 Exhaust end section  
b = 180mm

Preparing the exhaust pipe

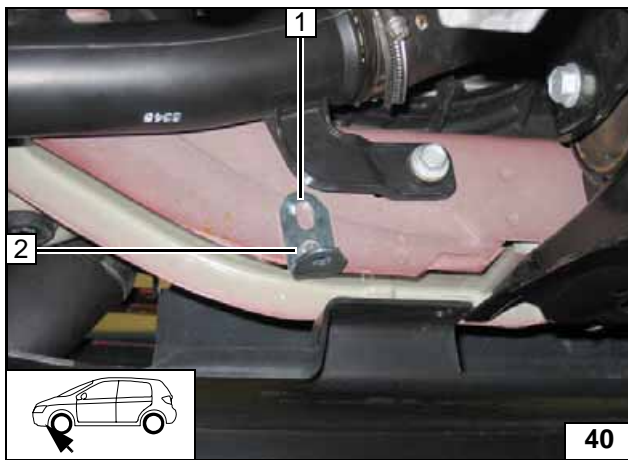

- 1 Angle bracket
- 2 M6x20 bolt, M6 flanged nut on existing hole

Assembling the angle bracket

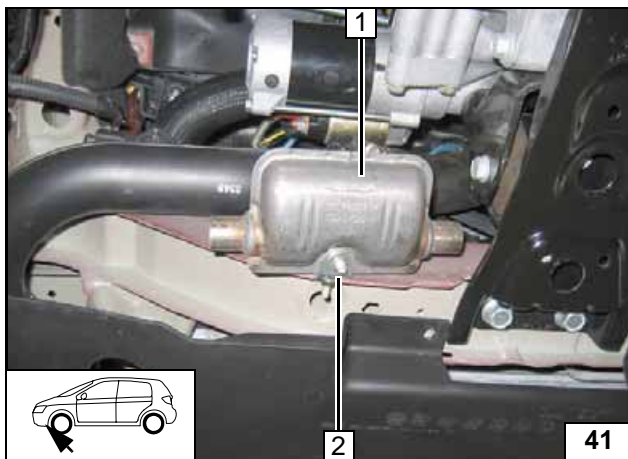

- 1 Exhaust silencer
- 2 M6x20 bolt, M6 flanged nut on bracket

Assembling the spacer nut

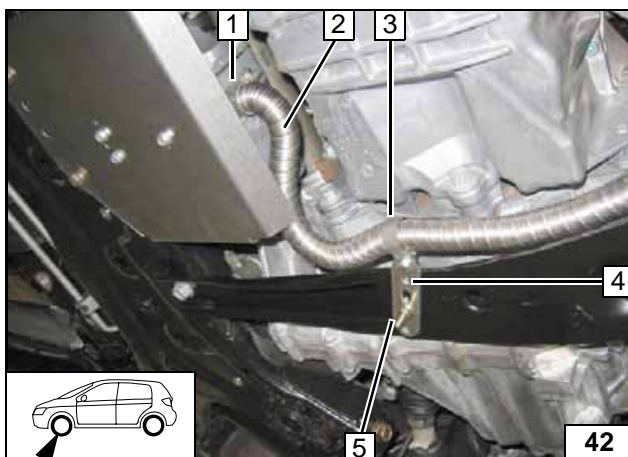

- 1 Hose clamp
- 2 Exhaust pipe
- 3 Tube clamp, M6x20 bolt, flanged nut M6 on fastening strap
- 4 Fastening strap with holes
- 5 M6x25 bolt, flanged nut on existing hole

Assembling the exhaust pipe

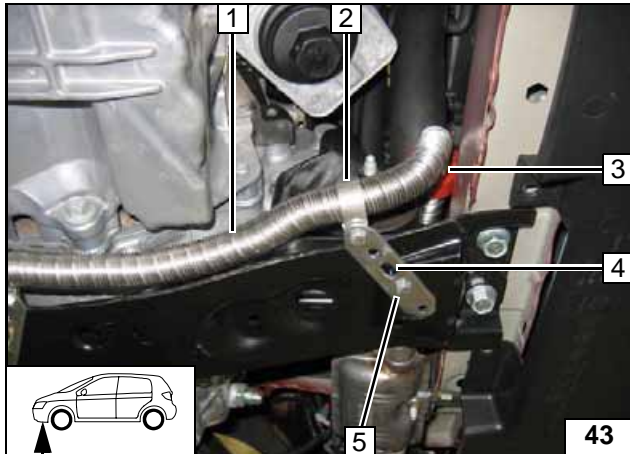
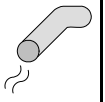

- 1 Exhaust pipe
- 2 Tube clamp, M6x20 bolt, flanged nut M6 on fastening strap
- 3 Slide the rubber profile onto the exhaust line.
- 4 Fastening strap with holes
- 5 M6x25 bolt, flanged nut on existing hole

**Assembling the exhaust pipe**

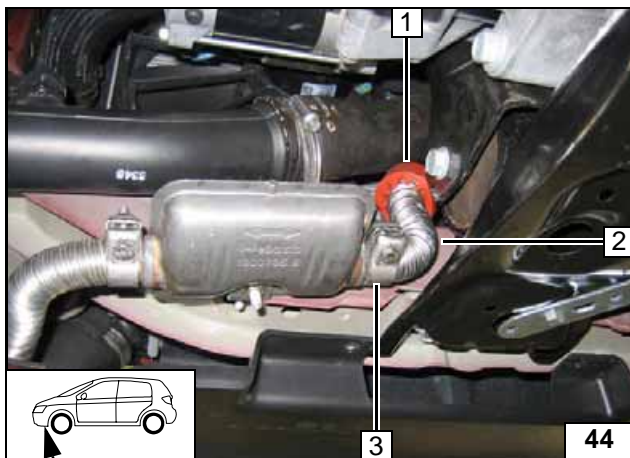

- 1 Align rubber profile according to the illustration
- 2 Exhaust pipe
- 3 Hose clamp

**Assembling the exhaust pipe**

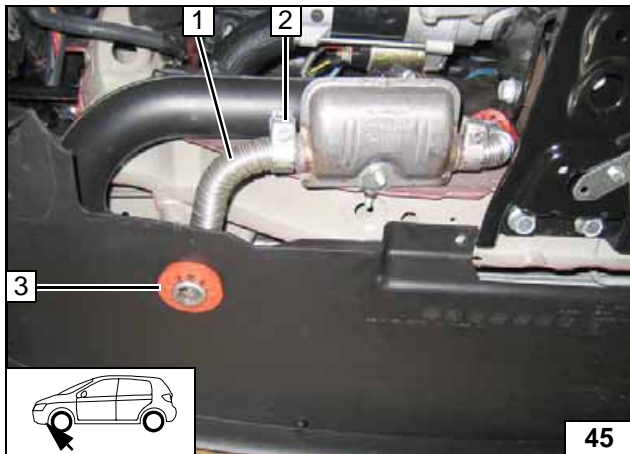

Drill  $\varnothing$  42mm in the underbody protection at position 3 and insert red rubber profile. Align the exhaust end section 1 flush with the red (rt) rubber profile 3.



**Assembling the exhaust end section**



**Water Connection**

**WARNING!**

Tighten all hose clamps to 2.0 + 0.5 Nm.

Any coolant running off should be collected using an appropriate container!

Install hoses so that they are kink-free! Unless specified otherwise, always fasten using cable clips!

Position hose clamps so that no other hose can be damaged!

The connection should be "inline" based on the following diagram:



Water installation diagram

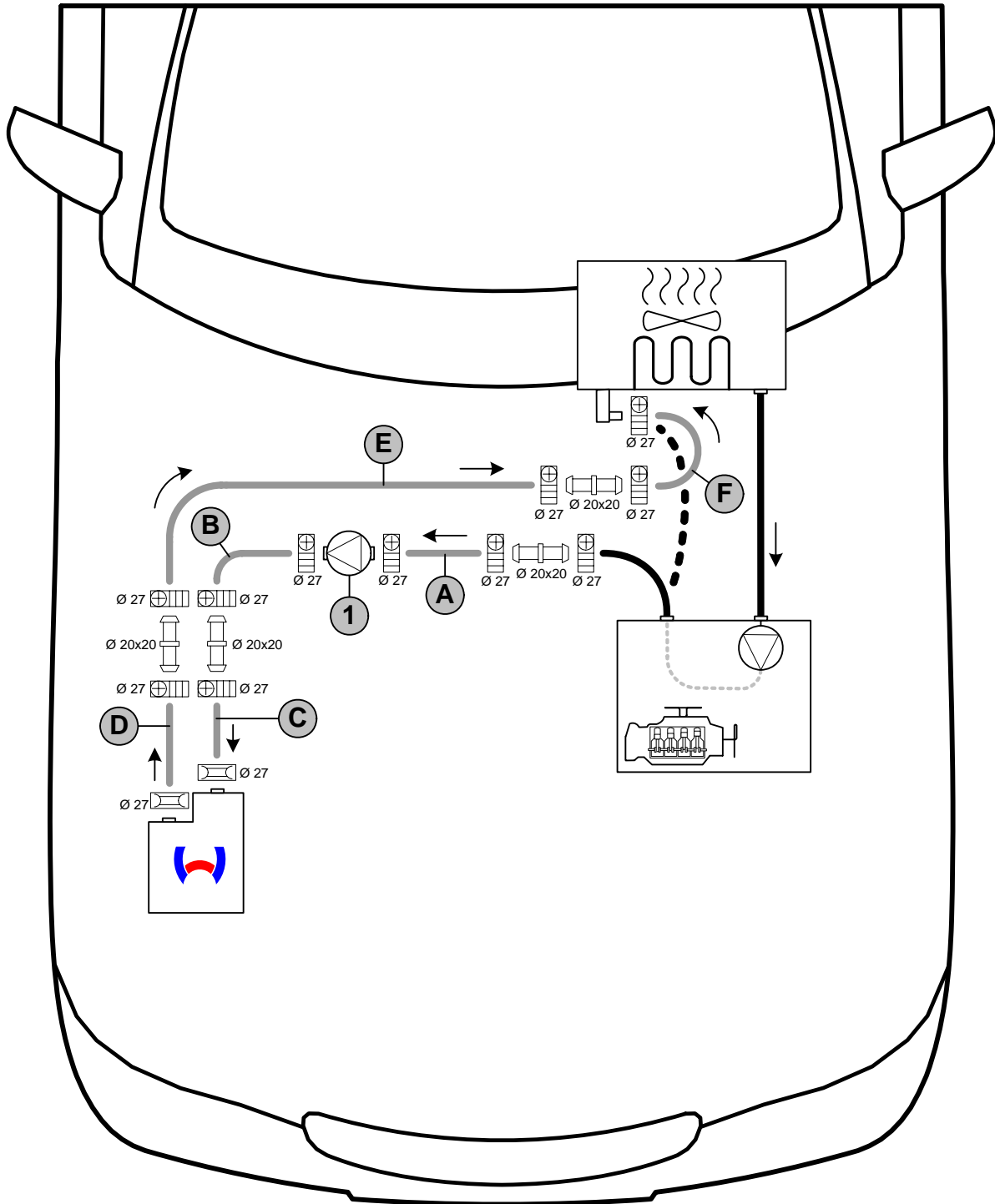

| Symbol | Description     |
|--------|-----------------|
|        | Connecting pipe |

| Symbol | Description |
|--------|-------------|
|        | Hose clamp  |

| Position | Description      |
|----------|------------------|
| 1        | Circulation pump |



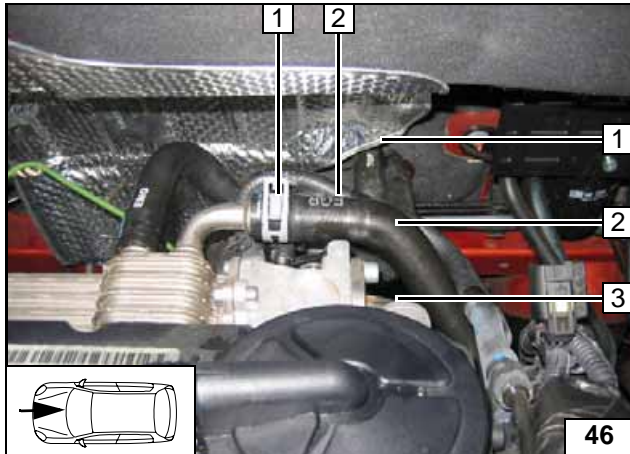
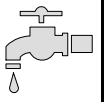

Disconnect engine outlet hose 2 from heat exchanger inlet supports. Dispose of spring band clamp 1.



Splitting point

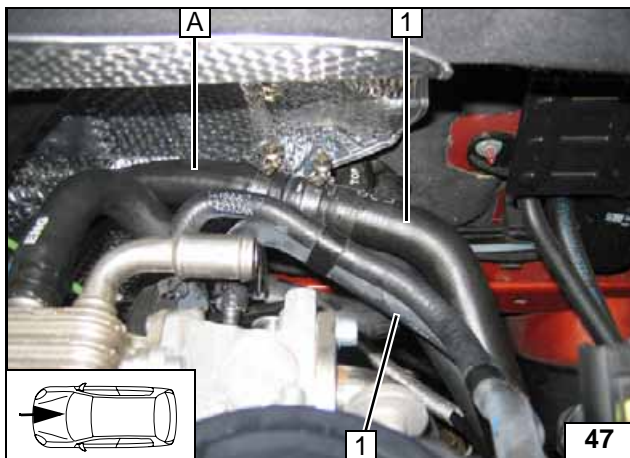

1 Connect engine outlet hose section with hose A

Connecting engine outlet

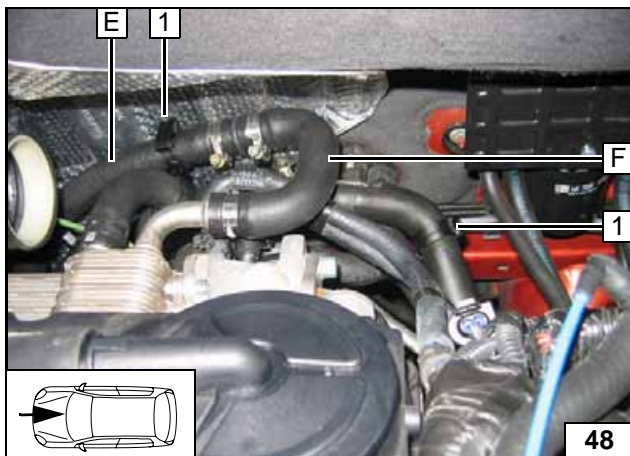

Connect hose F (enclosed 180° bend) with hose E and connect to the heat exchanger inlet connecting piece. Before connecting, fill the water hoses with coolant.

1 Spacer bracket [2x]



Heat exchanger inlet connection

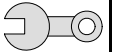

## Final Work

### WARNING!

Reassemble disassembled components in reverse order.

Check that all hose lines, clips, and all electrical connections are securely fastened.

Secure all loose cables using cable clips.

Only use manufacturer-approved coolant.

Spray heating unit components with anti-corrosion wax (Tectyl 100K, Order No. 111329).

- Connect battery
- Fill and bleed the coolant circuit according to the vehicle manufacturer's specifications.
- Set the time switch.
- Set the manual air conditioning or automatic air conditioning according to the "operating instructions for the end customer".
- Check that the auxiliary heating operates properly, see operating instructions / installation instructions.
- Attach the "Switch off auxiliary heating before re-fuelling" sticker onto the left side of the B-pillar.



- 1 Body washer, bolt protector at bolt M6x25



Prepare to mount underide protection

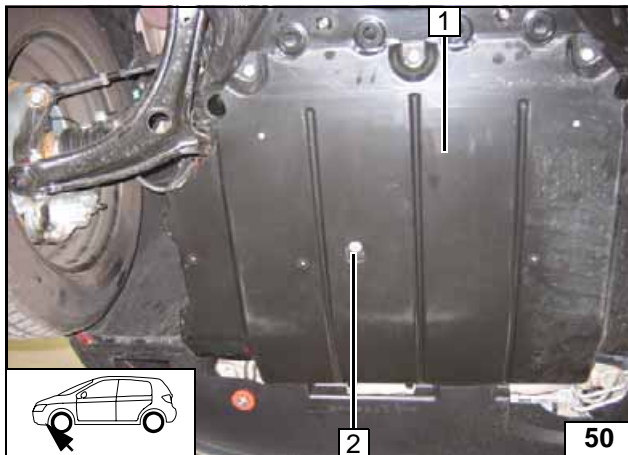

- 1 Underide protection
- 2 M6 flanged nut on bolt M6x25



Assembling the underide protection



Webasto AG  
 PO Box 80 - 82132 Stockdorf  
 Hotline 01805 / 932278 - Hotfax 0395 / 5592-353  
<http://www.webasto.de>

**Operating instructions for the end customer**

Please remove page and add to the vehicle operating instructions.



**Note:**

We recommend adjusting the heating time to the driving time  
heating time = driving time

**Example:**

For a driving time of 20 minutes (one way) we recommend not exceeding 20 minutes of power on time.

If the summer / winter switch option is installed for the heater unit, switch this according to the season. The heater unit will then heat when set to Winter and only blow air to ventilate the passenger compartment when set to Summer.

**When leaving the vehicle, deactivate the interior monitoring according to the vehicle user's manual in preparation for starting the auxiliary heater.**

Before parking the vehicle, make the following settings:



- 1 Blower set to level "1" possibly "2"
- 2 Temperature to "max."
- 3 Air outlet to windscreen

For vehicles with manual air conditioning

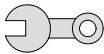

### Fastening Strap Template for the Metering Pump

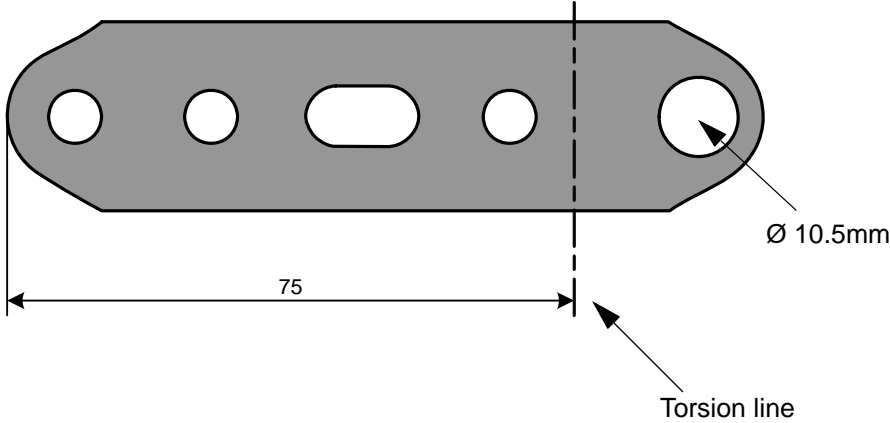

100mm

Scale 1:1

Compare the size of the printed version with dimension lines.  
Permitted tolerance a maximum of 2%.

Set the printer settings to "no margin" or "minimize margins" and 100% of the normal size.

100mm

0



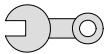

### Tank Extracting Device Template

