

Water Heater Unit



Thermo Top E Additional Heater ^{e1} 00 0003

Thermo Top C Additional Heater ^{e1} 00 0002

Installation Instructions

Opel Corsa

Gasoline

from Model Year 2007

Left-hand drive vehicle

Manual transmission



WARNING!

Hazard warning:

Incorrect installation or repair of Webasto heating systems may cause a fire or result in the emission of carbon monoxide, which can be fatal. Serious or fatal injuries can be caused as a result.

Specialist company training, technical documentation, specialized tools and equipment are required to install and repair Webasto heating and cooling systems.

NEVER attempt to install or repair Webasto heating or cooling systems if you have not successfully completed the company training and thereby acquired the required technical skills, or if you do not have access to the required technical documentation, tools and equipment needed to carry out correct installation and repairs.

ALWAYS follow all Webasto installation and repair instructions and observe all warnings.

Webasto does not accept any liability for defects and damage that are attributable to installation by untrained staff.

Table of Contents

Validity	2	Preparing heater unit	12
Heater Unit/Installation Kit	3	Preparing installation location	12
Foreword	3	Installing heater unit	14
General Instructions	3	Combustion air	15
Special Tools	3	Exhaust system	16
Explanatory Notes on Document	4	Coolant connection	17
Preliminary Work	5	Fuel Connection	19
Heater unit installation location	5	Final Work	22
Preparing electrical system	6	Operating Instructions for End Customer	23
Electrical Connections	7	Template for Fuel Standpipe	24
Fan controller for manual air conditioning	8		
Automatic air-conditioning fan controller	9		
Remote option (Telestart)	11		

Validity

Manufacturer	Model	Type	EG-BE No./ABE
Opel	Corsa	S-D	e1 * 2001 / 116 * 0379 * ...

Engine type	Engine model	Output in kW	Displacement in cm ³
Z10XEP	Gasoline	44	998
Z12XEP	Gasoline	59	1229

Vehicle and engine types, equipment variants and national specifications not listed in these installation instructions have not been tested. However, installation according to these installation instructions may be possible.

The installation location of a digital timer and summer/winter switch should be confirmed with the end customer before installation.

Heater Unit/Installation Kit

Quantity	Description	Order No.:
1	Retail accessories with desired heater control	See price list
1	Installation Kit for Opel Corsa 1.0/1.2B from 2007	1315060A

Foreword

These installation instructions apply to Opel Corsa Gasoline vehicles - for validity, see page 2 - from model year 2007 and later, assuming technical modifications to the vehicle do not affect installation, any liability claims excluded. Depending on the vehicle version and equipment, modifications may be necessary during installation with respect to these installation instructions.

However, the stipulations in the "installation instructions" and "operating and maintenance instructions" for the *Thermo Top C/E* must always be observed.

The corresponding rules of technology and any information from the vehicle manufacturer should be observed during the installation work.

General Instructions

Installation should be carried out according to the general, standard rules of technology. Unless specified otherwise, fasten hoses, lines and wiring harnesses to original vehicle lines and wiring harnesses using cable ties.

Sharp edges must be provided with rub protection (cut-open fuel hose)!

Spray unfinished body areas, e.g. drilled holes, with anti-corrosion wax (Tectyl 100K, Order No. 111329).

Special Tools

- Torque wrench for 2.0 - 10 Nm
- Hose clamping pliers
- Metric thread-setter kit

Explanatory Notes on Document

To provide you with a quick overview of the individual working steps, you will find an identification mark on the outside top right corner of the page in question.

Mechanical system

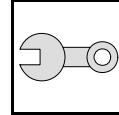

Electrical system

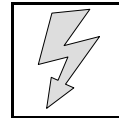

Coolant connection

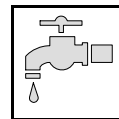

Fuel connection

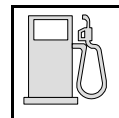

Exhaust system

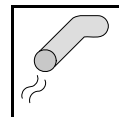

Combustion air

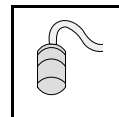

Special features are highlighted using the following symbols:



Specific risk of injury or fatal accidents.



Specific risk of damage to components.



Specific risk of fire or explosion.



Reference to general installation instructions of Webasto components or to the manufacturer's vehicle-specific documents.



Reference to a special technical feature.

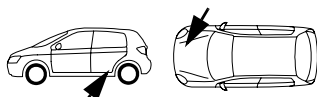

The arrow in the vehicle icon indicates the position on the vehicle and the viewing angle.

Preliminary Work

WARNING!

- Open the fuel tank cap and vent the fuel tank.
- Close the tank cap again.
- Disconnect battery "earth" or "ground" connection!
- Depressurize the cooling system!
- Copy the factory number from the original type label to the duplicate type label.
- Remove years that do not apply from duplicate label.
- Attach the duplicate label (type label) in the appropriate place.
- Remove the battery completely.
- Remove the wiper arms
- Remove the coolant reservoir cap.
- Expose the fuse and relay box in the engine compartment
- Remove the rear bench seat.
- Open the right-hand fuel sender service lid
- Remove fuel-tank sending unit in accordance with manufacturer's instructions.
- Remove the footwell trim on the driver's side.

Remove page 23 "Operating Instructions for End Customer" and insert with vehicle operating instructions.

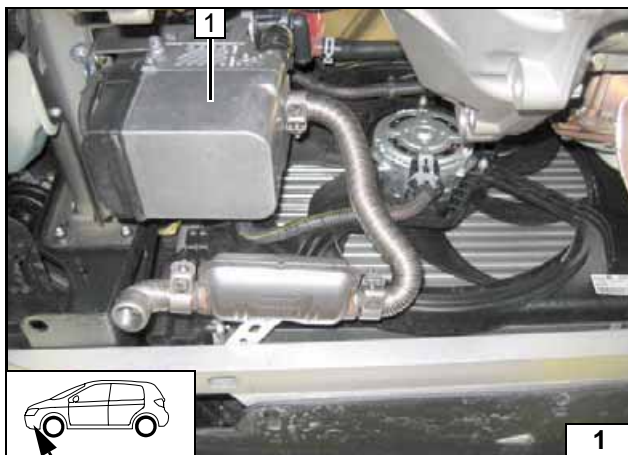

Heater unit installation location

1 Heater unit

Installation location

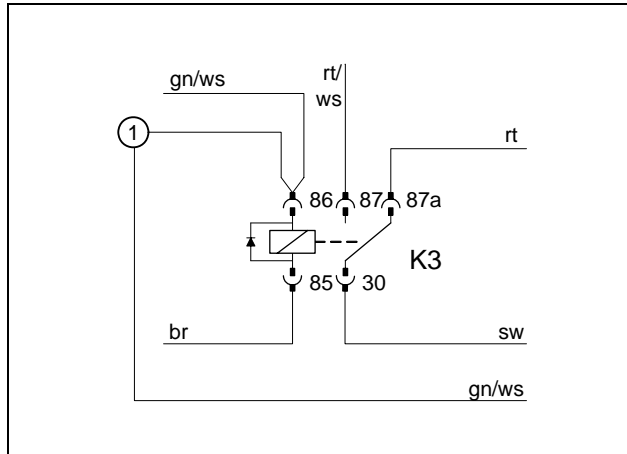

Preparing electrical system

Only with automatic air-conditioning

Produce connection as shown in wiring diagram with tab receptacle. Pull line section 1 (2,000 mm long, 0.75 mm²) into protective sleeving and install in passenger compartment together with wiring harness for digital timer and fan controller. This will be required later for connection of the A/C control panel.



Cutting wires to length



Electrical Connections

Fuse holder, K3 relay with manual air conditioning

- 1 7 mm dia. hole, M6x20 bolt, large diameter washer, flanged nut
- 2 Angle bracket
- 3 Retaining plate for fuse holder, M5x16 bolt, large diameter washer, K3 relay, flanged nut on angle bracket

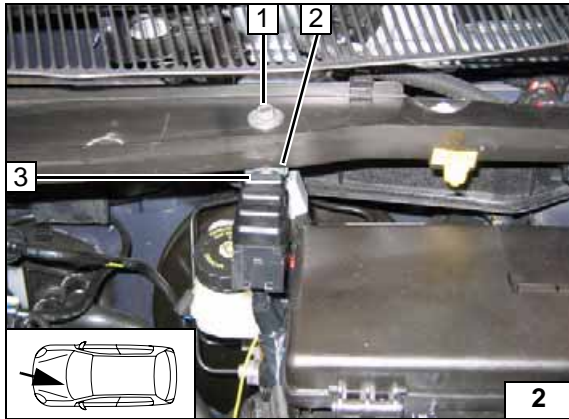

Digital timer

- 1 Digital timer

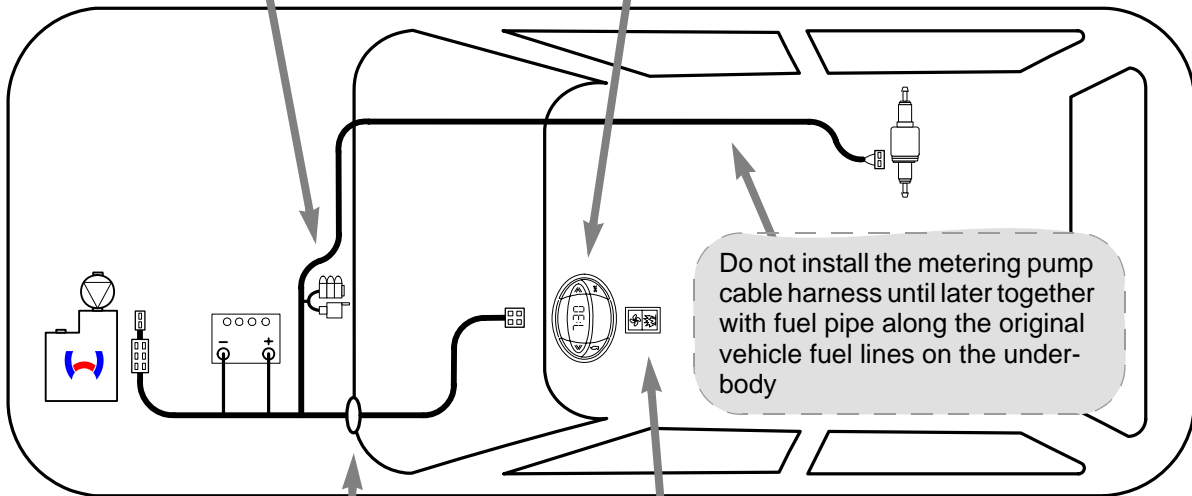
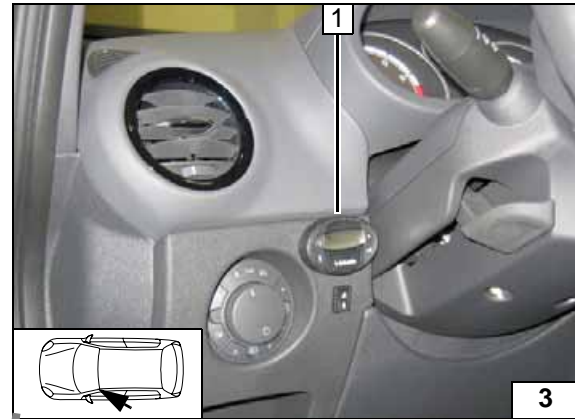

Wiring harness installation diagram

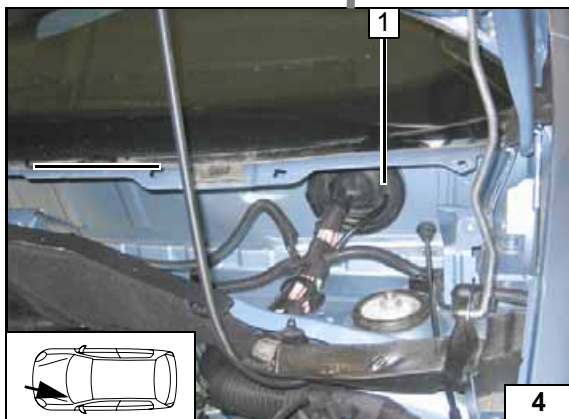

Wiring harness pass through

- 1 Protective rubber plug

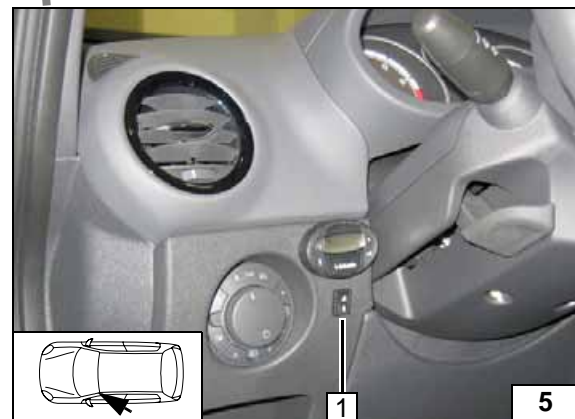

Summer/winter switch option

- 1 Summer/winter switch, drilled hole 12 mm dia.



Fan controller for manual air conditioning

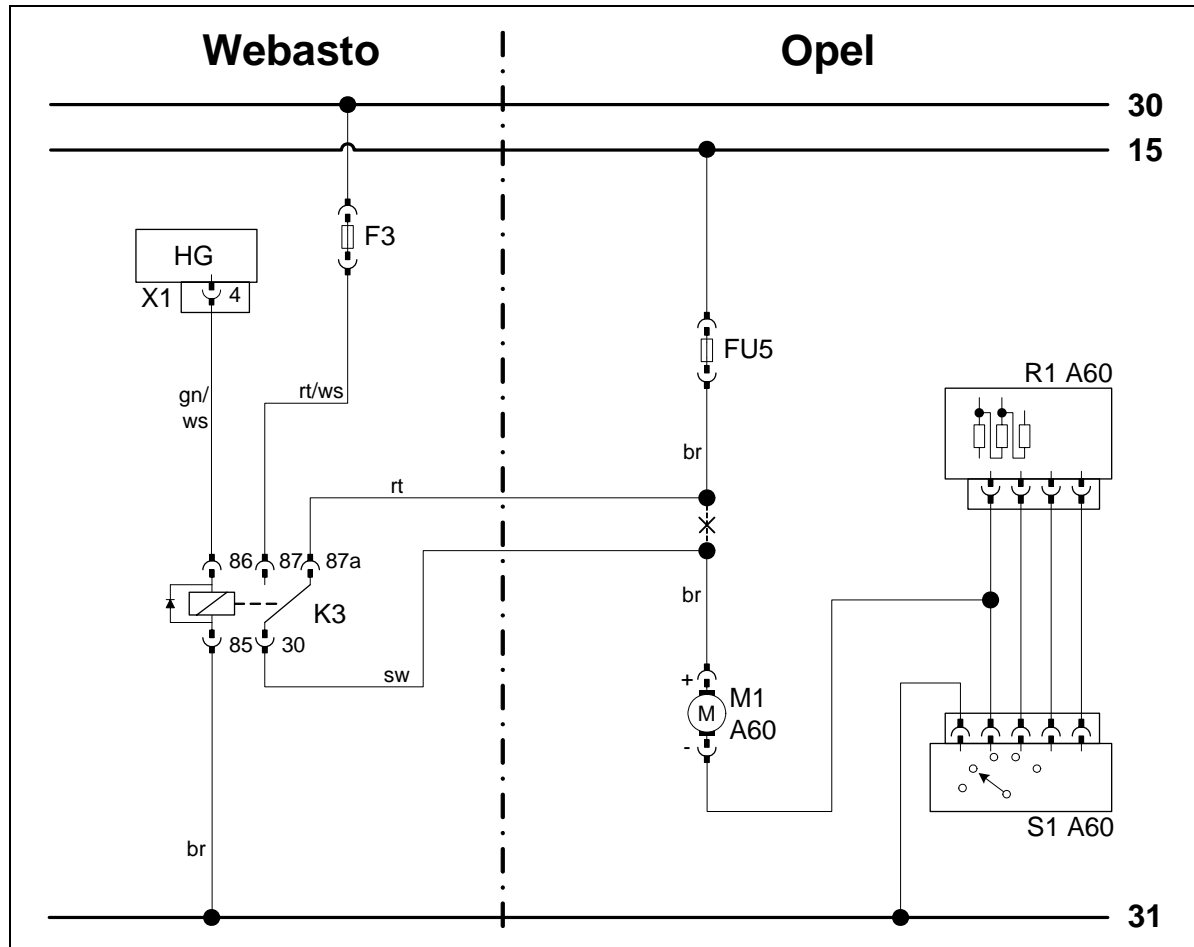

Wiring diagram

Webasto components		Vehicle components		Colors and symbols	
HG	Heater unit TT-C/E	M1 A60	Fan motor	rt	red
X1	6-pin connector	FU5	Fuse 40A	ws	white
F3	25 A fuse	R1 A60	Resistor group	sw	black
K3	Fan relay	S1 A60	Fan switch	br	brown
				gn	green
				X	Cutting point
				Wiring colors may vary.	

Legend

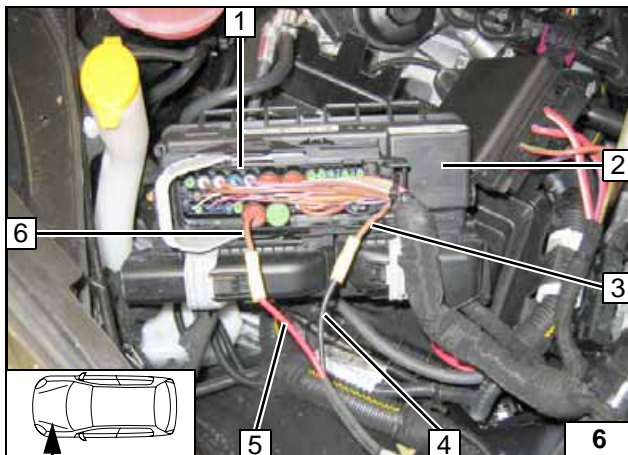

Connection to connector 1 of fuse and relay box 2.
Produce connections as shown in wiring diagram.

- 3 Brown (br) wire to fan motor
- 4 Black (sw) wire from K3/30
- 5 Red (rt) wire to K3/87a
- 6 Brown (br) wire from fuse FU5



Connecting fan-motor



Automatic air-conditioning fan controller



Wiring diagram

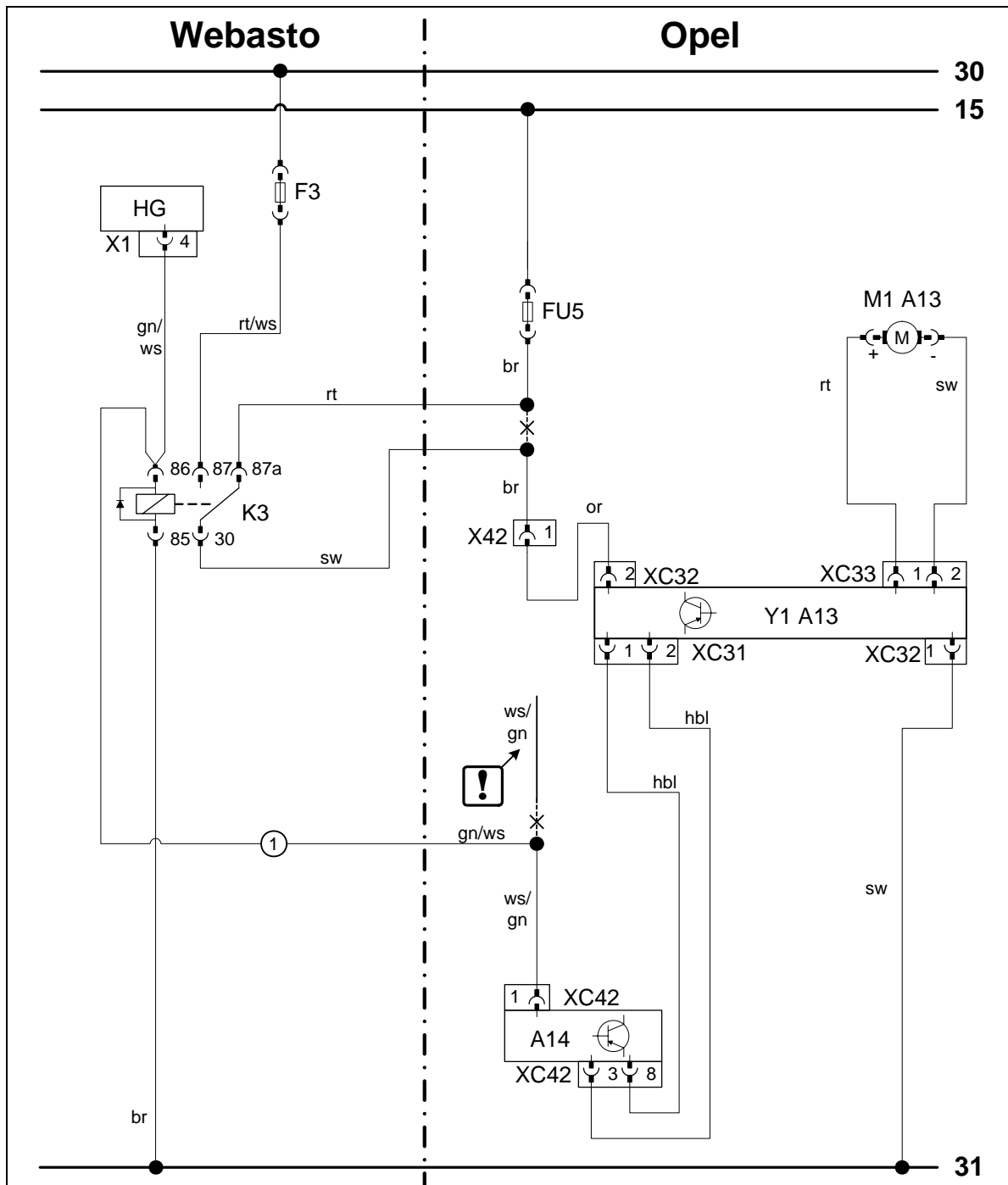

Webasto components		Vehicle components		Colors and symbols	
HG	Heater unit TT-C/E	M1 A13	Fan motor	rt	red
X1	6-pin heater unit connector	FU5	Fuse 40A	ws	white
F3	25 A fuse	Y1 A13	Fan controller	sw	black
K3	Fan relay	A14	A/C control panel	br	brown
		XC.....	Connector designations	gn	green
		X...	Connector designations	hbl	light blue
				or	orange
					Insulate wire ends and tie back
				X	Cutting point
				Wiring colors may vary.	

Legend

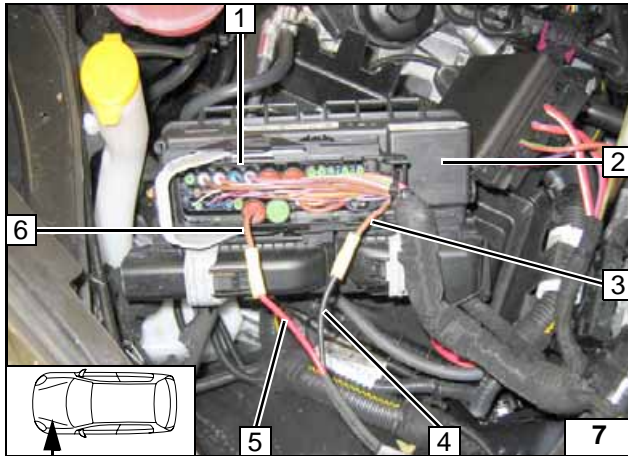

Connection to connector **1** of fuse and relay box **2**.
Produce connections as shown in wiring diagram.

- 3** Brown (br) wire to fan controller Y1 A13
- 4** Black (sw) wire from K3/30
- 5** Red (rt) wire to K3/87a
- 6** Brown (br) wire from fuse FU5

**Connect-
ing fan-mo-
tor**

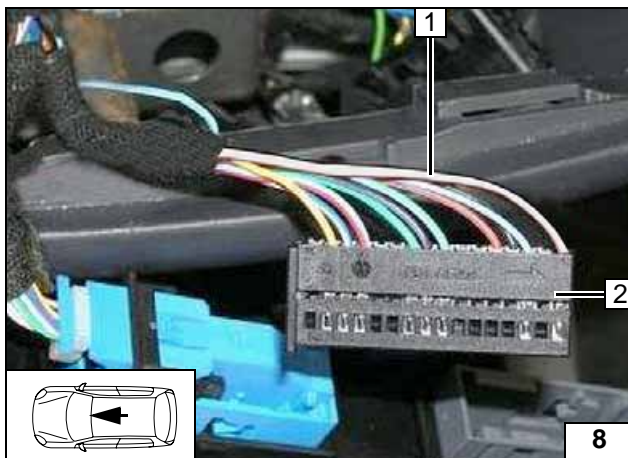

Connection to gray 32-pin connector **2** from the air conditioning control.
Disconnect white/green (ws/gn) wire **1** and produce connection as shown in wiring diagram with connector.

WARNING!

If no white/green (ws/gn) wire is connected to Pin 1, the green/white (gn/ws) wire from K3/86 is connected there with a suitable plug-in contact.

**Connect-
ing A/C
control
panel**



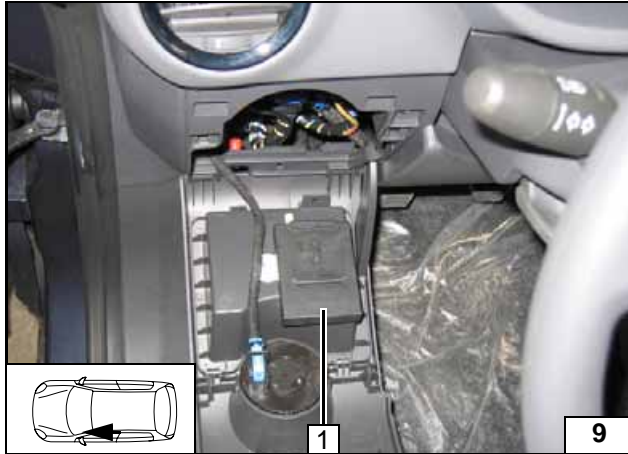

Remote option (Telestart)

Fasten receiver 1 with suitable means (double-sided adhesive tape).



Installing receiver

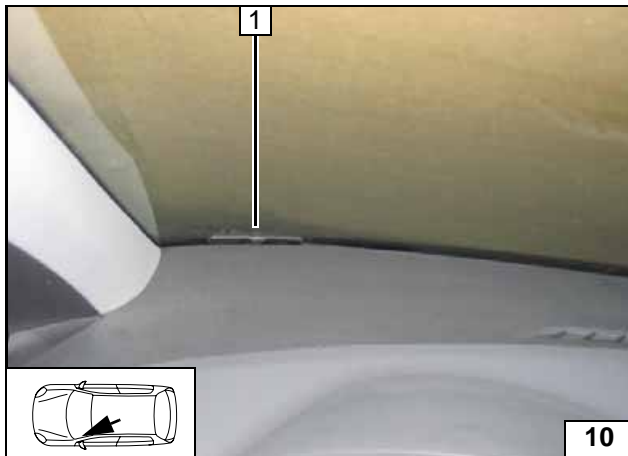

1 Antenna

Installing antenna

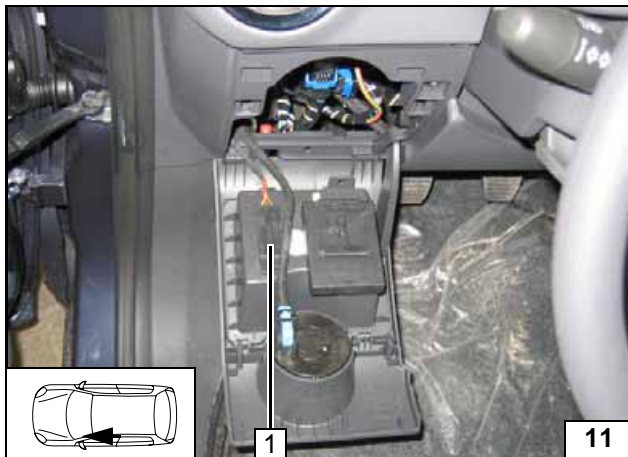

Temperature sensor for HTM100 only

Fasten temperature sensor 1 with suitable means (double-sided adhesive tape).



Installing temperature sensor

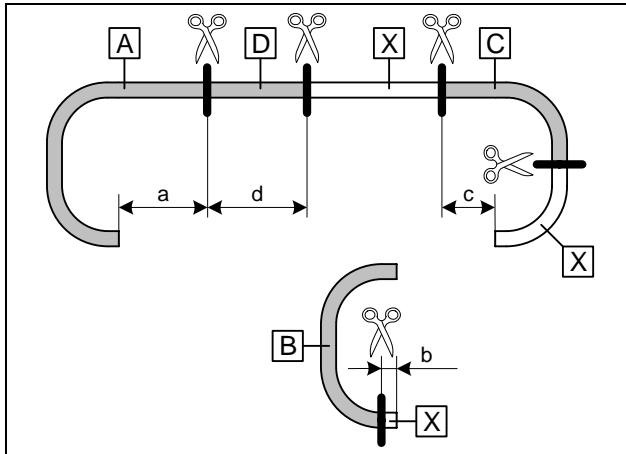
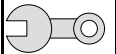

Preparing heater unit

- a = 200 mm
- b = 20 mm
- c = 60 mm
- d = 260 mm

Discard section X



Cutting coolant hoses to length

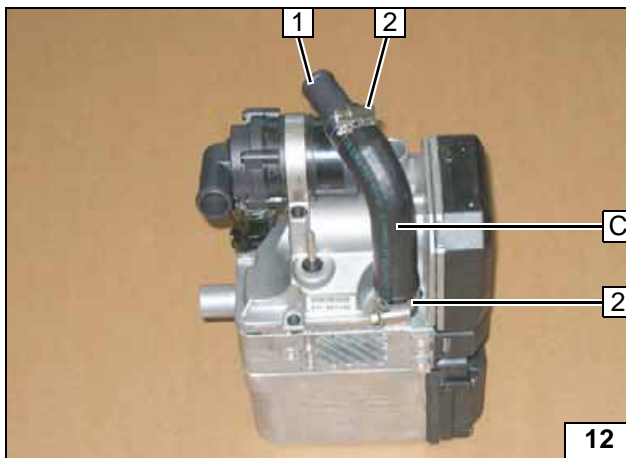

- 1 20x20 connecting pipe
- 2 27 mm dia. hose clamp [2x]

Preassembling hose C on heater unit

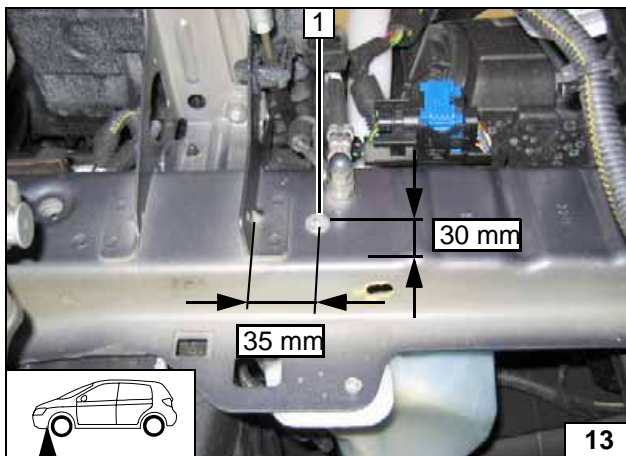

Preparing installation location

- 1 Drill 9.1 mm dia. hole; install rivet nut

Installing rivet nut

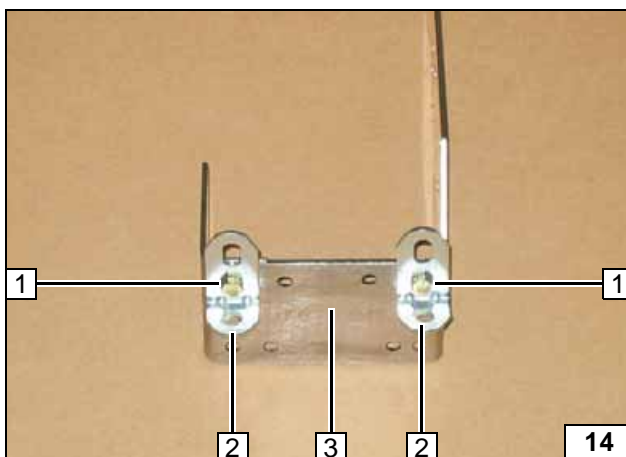

- 1 M6x12 bolt, flanged nut [2x each]
- 2 Angle bracket [2x]
- 3 Bracket

Premounting bracket

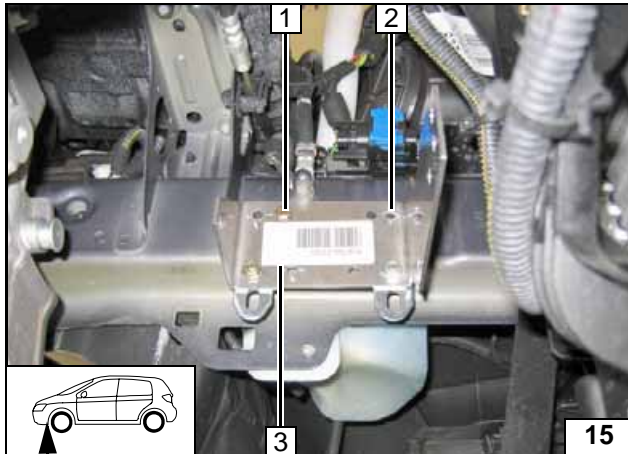
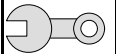

- 1 Loosely screw M6x30 bolt into rivet nut
- 2 Copy hole pattern
- 3 Bracket

Copying hole pattern

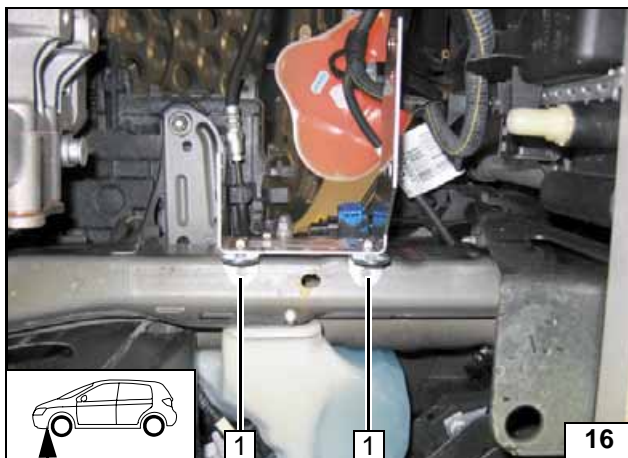

- 1 Copy hole pattern [2x], remove bracket

Copying hole pattern

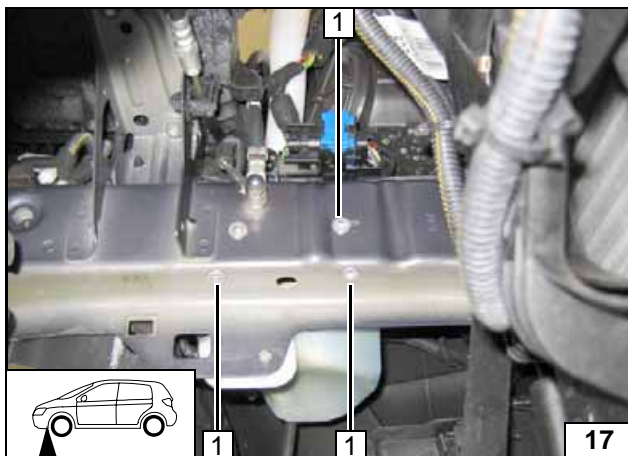

- 1 Drill 9.1 mm hole; install rivet nut [3x each]

Installing rivet nut

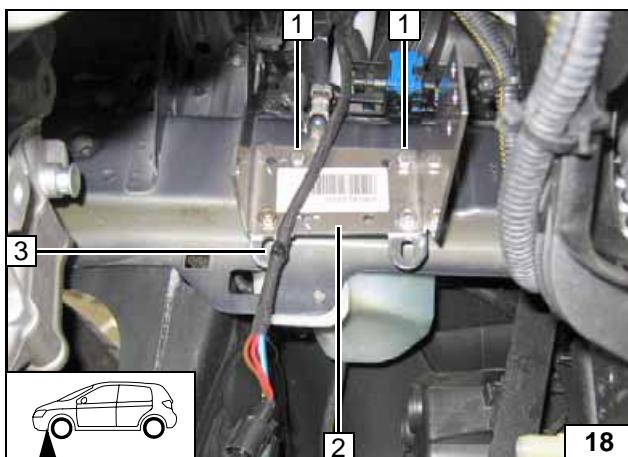

Insert one 5 mm shim each between bracket 2 and frame side member at position 1.

- 1 Mount M6x30 bolt, spring lockwasher, 5 mm shim on rivet nut [2x each]
- 3 Wiring harness of heater unit, cable tie on angle bracket



Installing bracket

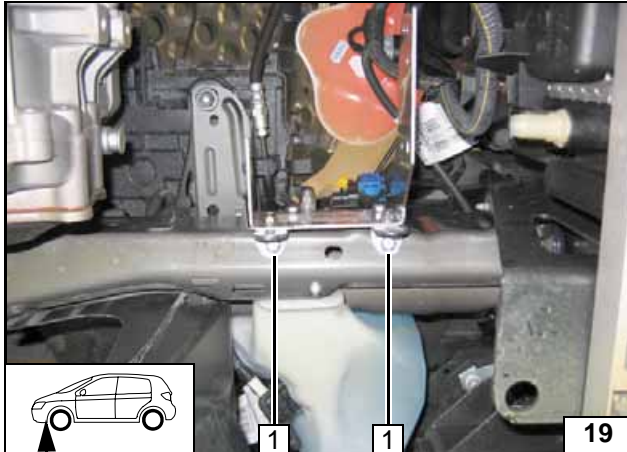
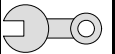

1 Mount M6x20 bolt, spring lockwasher on rivet nut [2x each]

Installing bracket

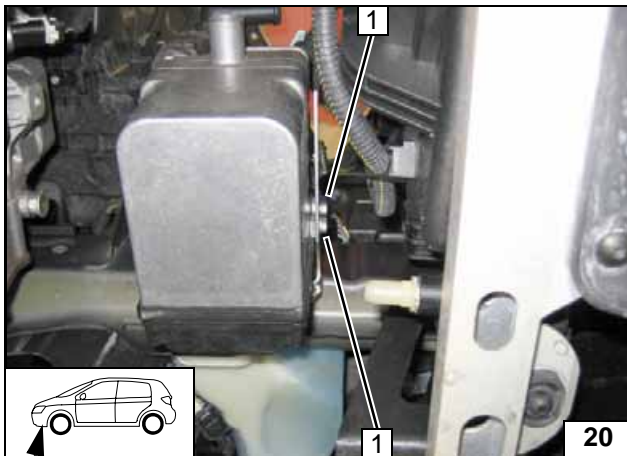

Installing heater unit

Ejot screw bolt, tightening torque 10 Nm!

1 E-jot screw [2x]



Installing heater unit

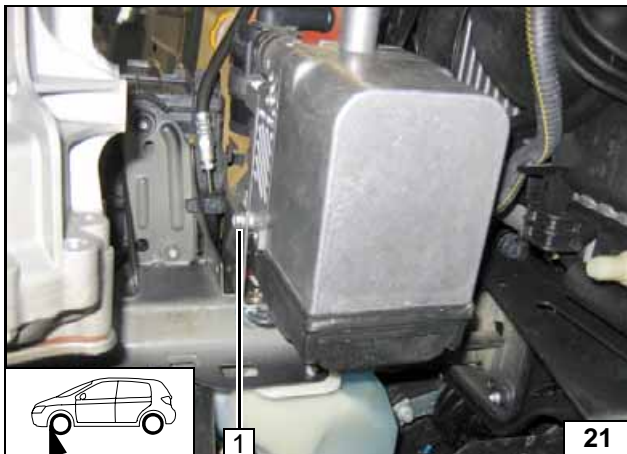

Ejot screw bolt, tightening torque 10 Nm!

1 E-jot screw



Installing heater unit

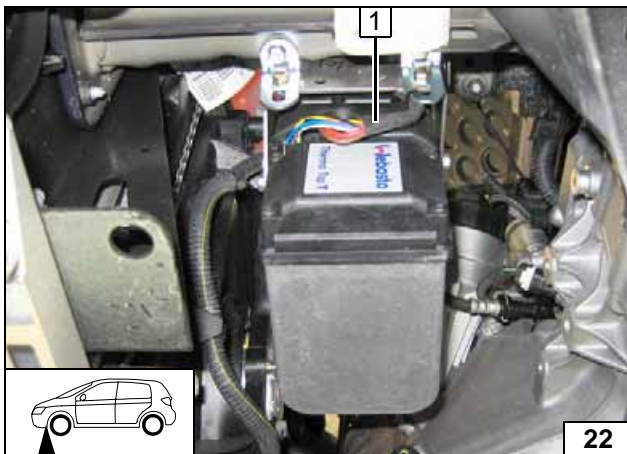

1 Wiring harness of heater unit

Connecting wiring harness

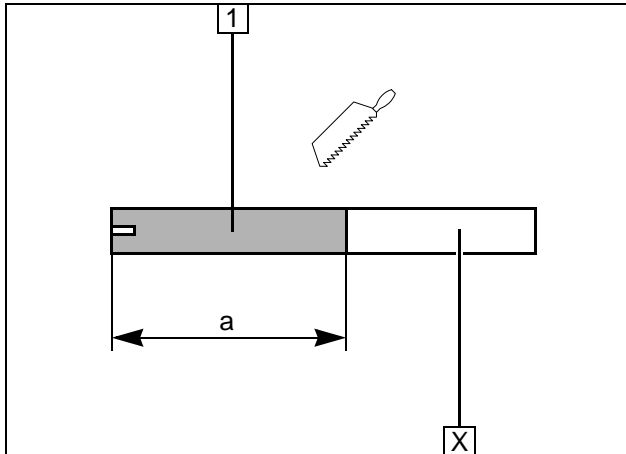

Combustion air

- 1 Combustion air pipe
a = 250 mm

Discard section X

Cutting combustion air pipe to length

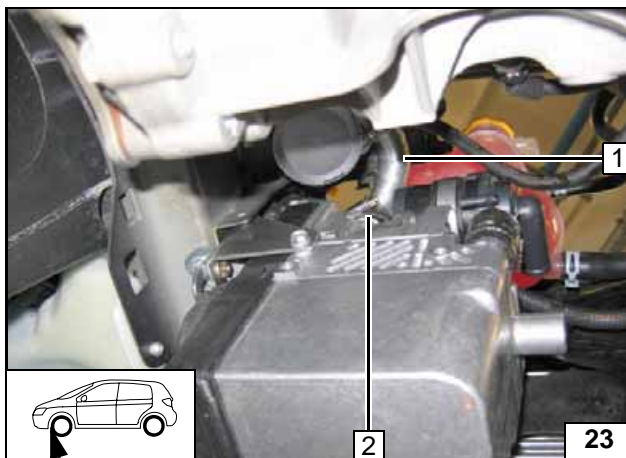

- 1 Combustion-air intake pipe
- 2 27 mm dia. hose clamp

Installing intake pipe

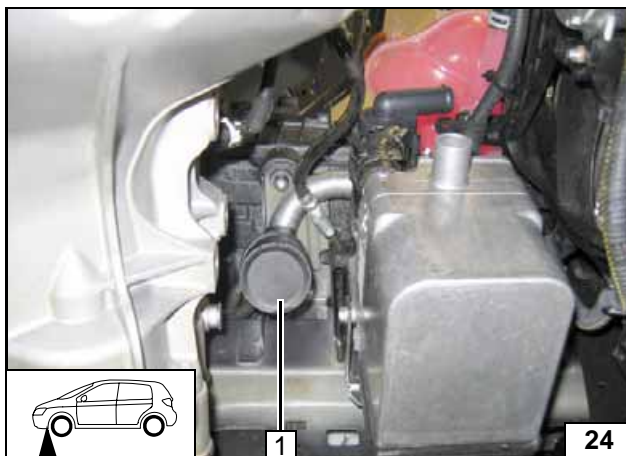

- 1 Combustion-air intake muffler



Installing muffler

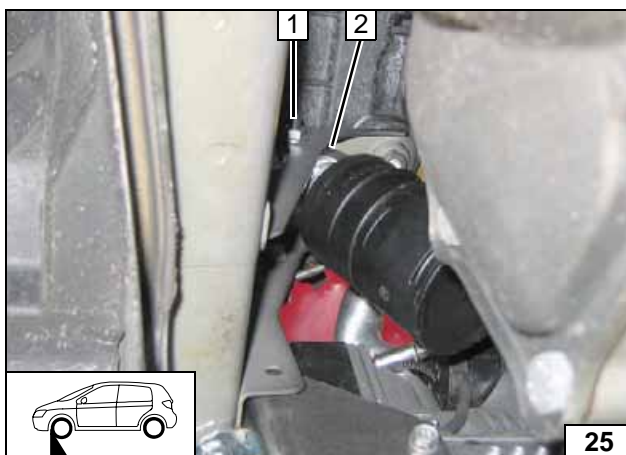

- 1 Mount M6x20 bolt, flanged nut in existing hole
- 2 Combustion-air intake pipe, p-clamp

Fastening intake pipe

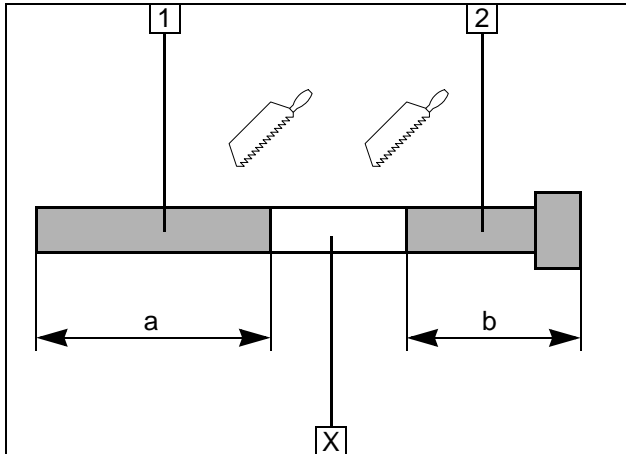
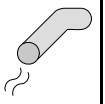

Exhaust system

- 1 Exhaust pipe
a = 280 mm
- 2 Exhaust end section
b = 80 mm

Discard section X

Preparing exhaust pipe

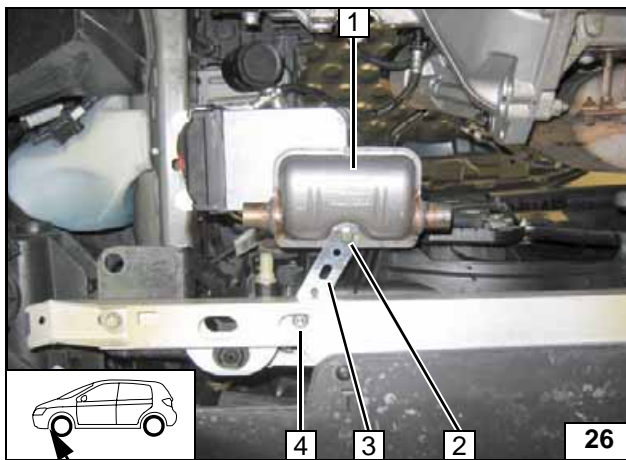

- 1 Muffler
- 2 M6x20 bolt, flanged nut
- 3 Perforated bracket
- 4 Mount M6x20 bolt, large diameter washer, flanged nut in existing hole

Installing muffler

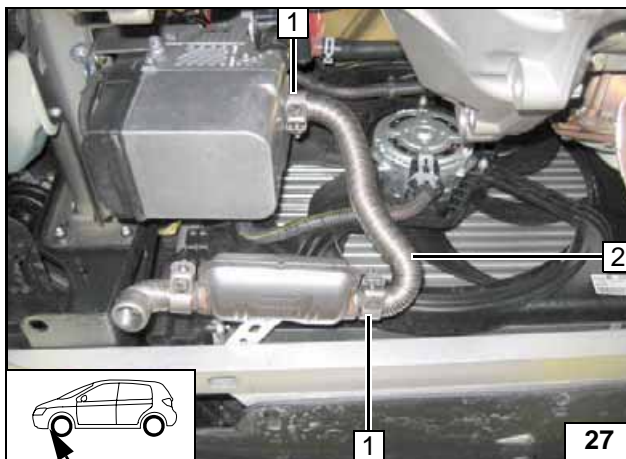

- 1 Hose clamp [2x]
- 2 Exhaust pipe

Installing exhaust pipe

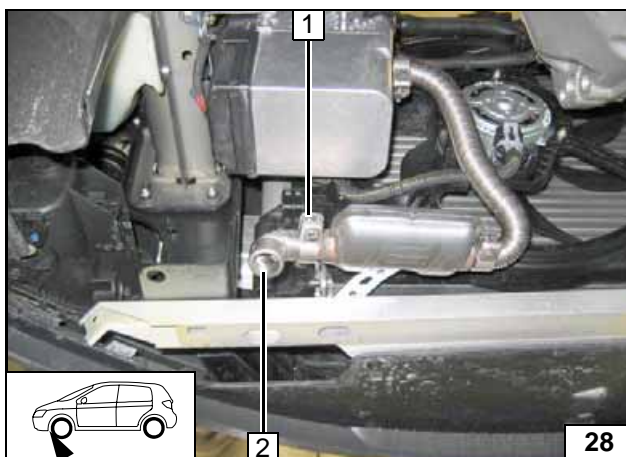

- 1 Hose clamp
- 2 Exhaust end section

Installing end section



Coolant connection

WARNING!

Tighten all hose clamps to 2.0 + 0.5 Nm.

Any coolant running off should be collected using an appropriate container!

Route coolant hoses kink-free! Unless specified otherwise, always fasten using cable ties.

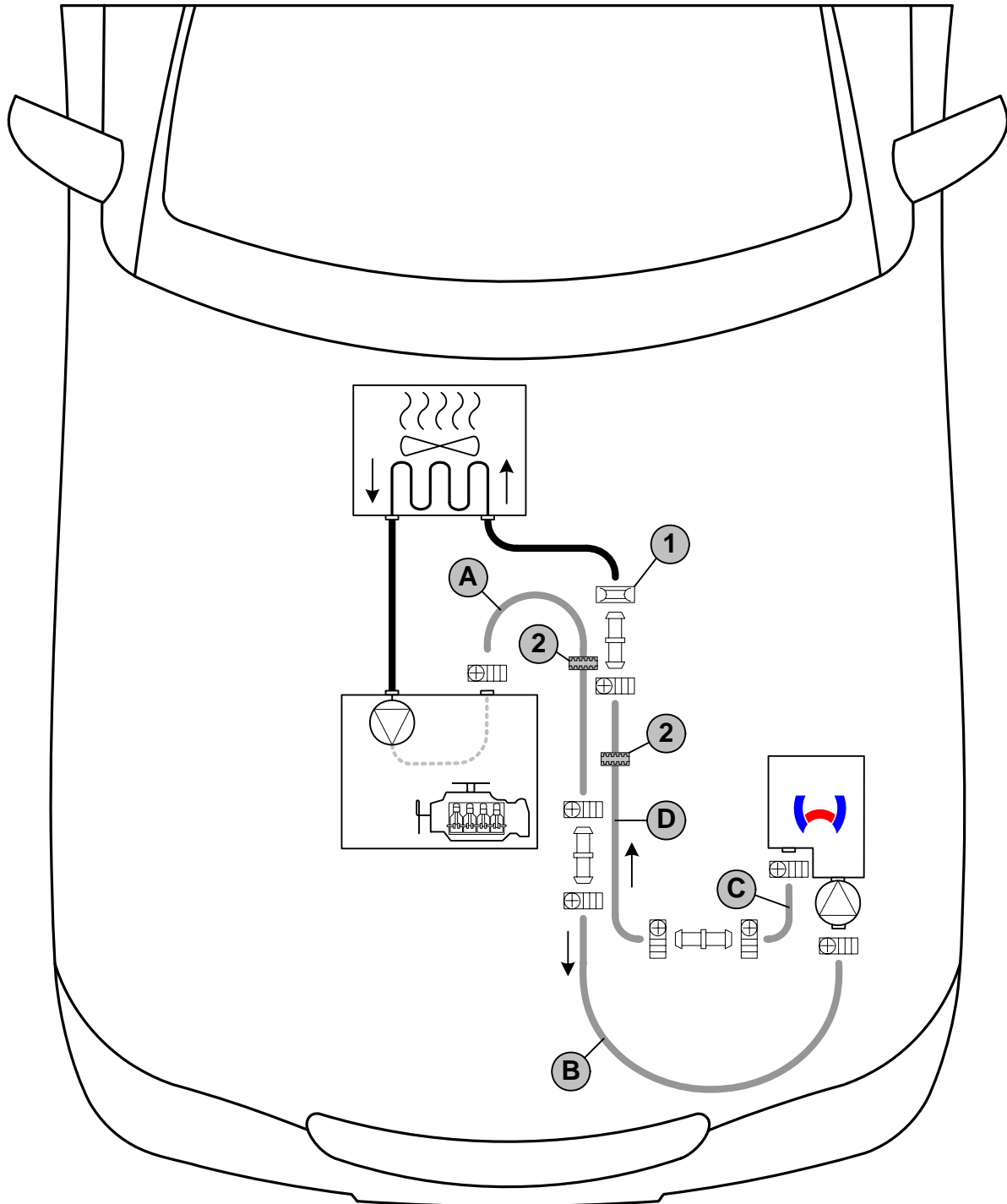

Position hose and spring clips so that no other hose can be damaged!

The connection should be "inline" based on the following diagram:



Coolant routing diagram

All connecting pipes = dia. 20x20. 1 = Original vehicle spring clip .

All hose clamps without a specific designation  = 20-27 mm dia 2 = Black (sw) rubber isolator 



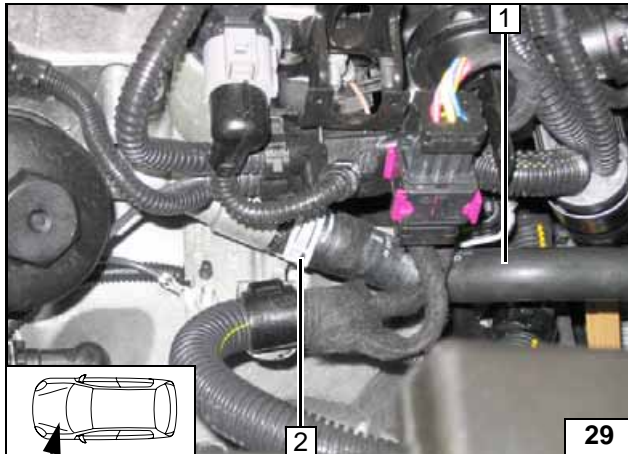

Disconnect hose to heat exchanger inlet 1 on connection piece of engine outlet. Spring clip 2 will be reused.



Cutting point

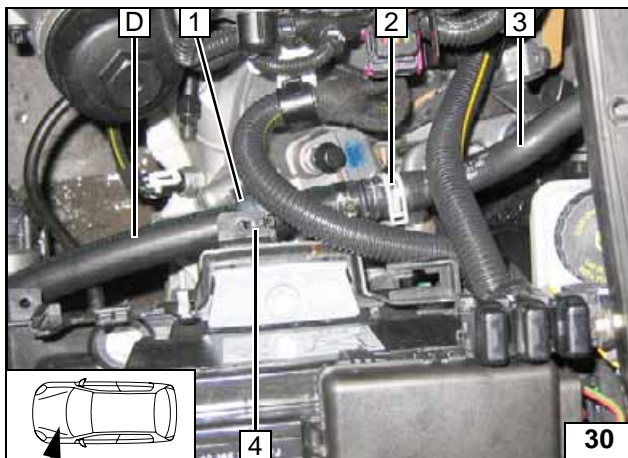

- 1 Slide black (sw) rubber isolator onto hose D
- 2 Original vehicle spring clip
- 3 Original vehicle hose to heat exchanger inlet
- 4 Cable tie

Connecting heat exchanger inlet

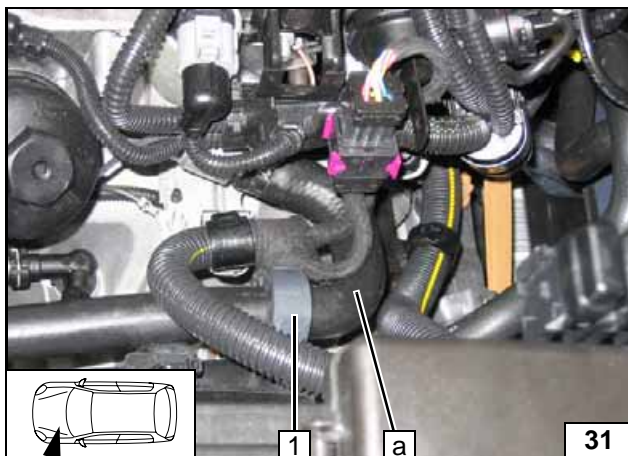

- 1 Slide black (sw) rubber isolator onto hose A and position

Connecting engine outlet

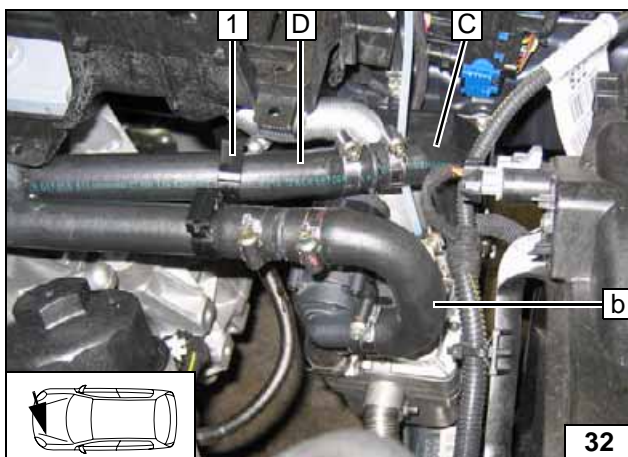

Connect hose B with short leg to circulating pump.

- 1 Spacer bracket



Connecting heater unit



Fuel Connection

CAUTION!

Open the vehicle's fuel tank cap, ventilate the tank and then re-close the tank lock.

Catch any fuel running off with an appropriate container.

Install fuel line and metering-pump wiring harness so that they are protected against stone impact. Unless specified otherwise, always fasten using cable ties. Mount the fuel line and wiring harness with rub protection on sharp edges.

WARNING!

The fuel line and wiring harness are routed to the metering pump in as shown in the wiring harness routing diagram.

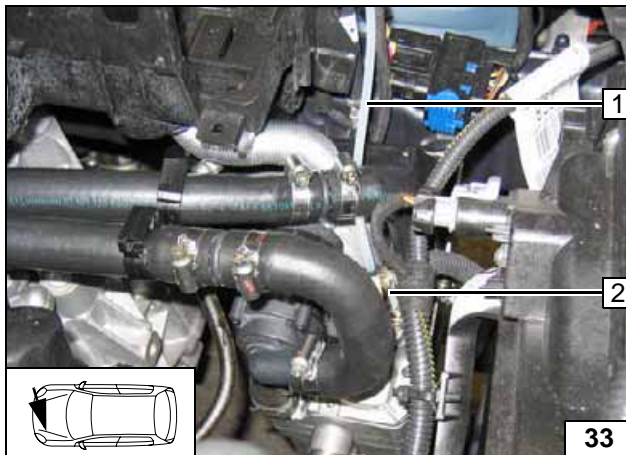

- 1 Fuel line
- 2 Hose section, 10 mm dia. hose clamp [2x]

Connect-
ing heater
unit



- 1 Connect fuel line, wiring harness of metering pump to original vehicle lines

Installing
lines

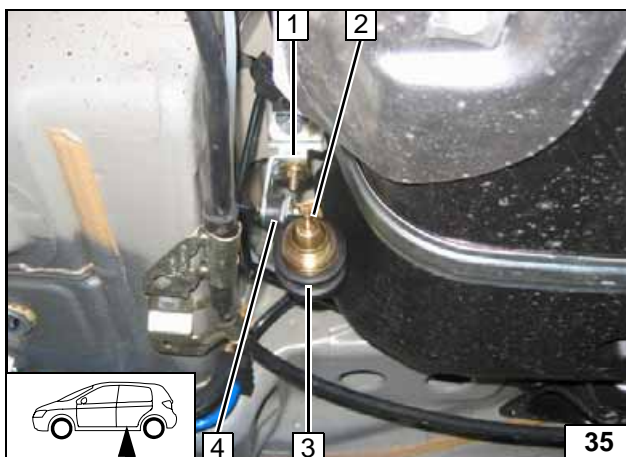

Ensure proper installation position of metering pump 2, see "Installation Instructions". Installation location in front of vehicle fuel tank!

- 1 Mount M6x20 bolt, angle bracket, large diameter washer, flanged nut in original vehicle hole
- 3 Rubber-coated pipe clamp
- 4 Silent block, flanged nut [2x]



Install-
ation loca-
tion of
metering
pump

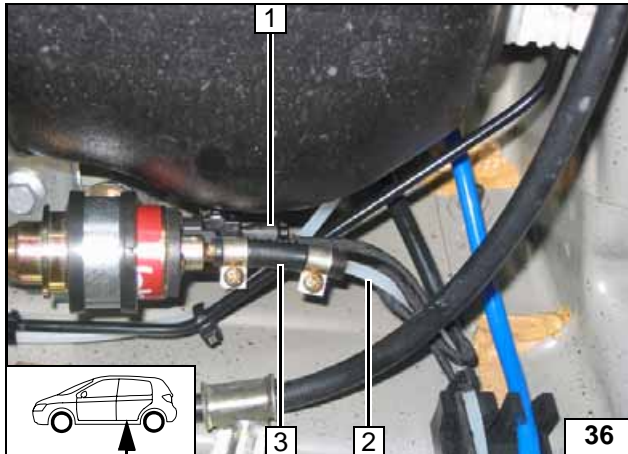

Connect fuel line 2 from heater unit to pressure side of metering pump [side with connector].

- 1 Wiring harness of metering pump, connector mounted
- 3 Hose section, 10 mm dia. hose clamps [2x]

Connecting metering pump

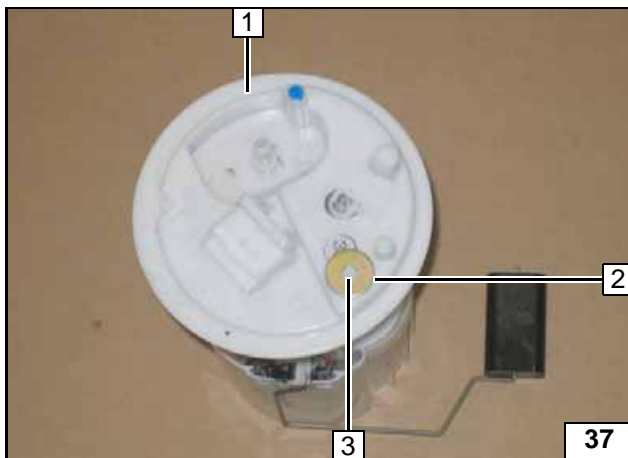

Remove fuel-tank sending unit 1 in accordance with manufacturer's specifications.

- 2 22 mm dia. large diameter washer
- 3 Copy hole pattern, 6 mm dia. hole



Removing fuel

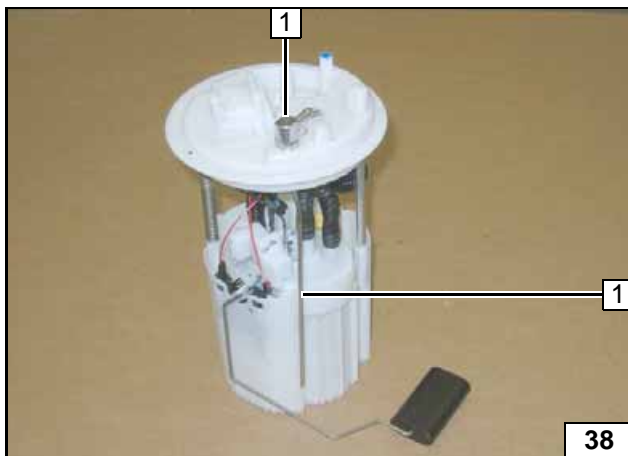

Shape fuel standpipe 1 according to template, cut to length and install, see "installation instructions".



Installing fuel standpipe

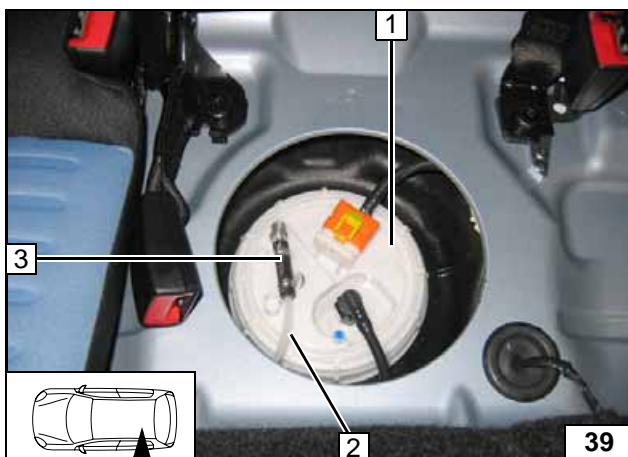

Install fuel-tank sending unit 1 in accordance with manufacturer's specifications.

- 2 Fuel line
- 3 Molded hose, 10 mm dia. Caillau clamp [2x]



Connecting fuel line

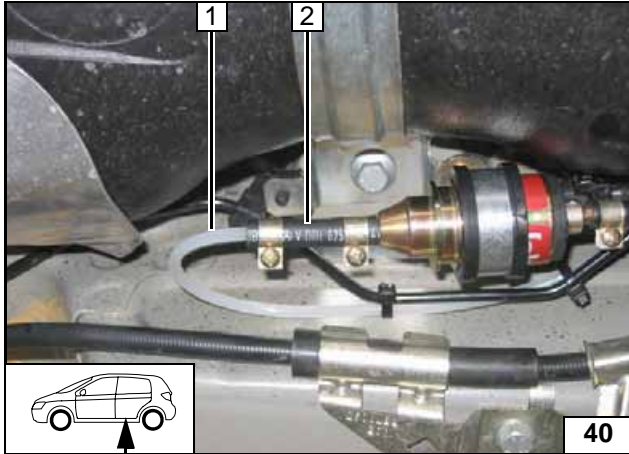

Fuel line **1** from fuel standpipe on intake side of metering pump [side without connector]. Check position of components; adjust if necessary. Check that they have free clearance.

2 Hose section, 10 mm dia. hose clamp [2x]



**Connect-
ing meter-
ing pump**



Final Work

WARNING!

Mount removed parts in reverse order.

Check all hoses, clamps and all electrical connections for firm seating.

Secure all loose cables using cable ties.

Only use manufacturer-approved coolant.

Spray heater unit components with anti-corrosion wax (Tectyl 100K, Order No. 111329).

- Connect the battery.
- Fill and bleed the coolant circuit according to the vehicle manufacturer's specifications.
- Set the digital timer.
- Set the manual air conditioning or automatic air conditioning according to the "operating instructions for the end customer".
- Check the proper operation of the additional heater, see the operating instructions/installation instructions.
- Attach the "Switch off additional heater before refueling" sticker to the left-hand B-pillar.



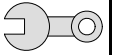

Operating Instructions for End Customer

Please remove page and add to the vehicle operating instructions.



Note:

We recommend matching the heating time to the driving time.

Heating time = driving time

Example:

For a driving time of approx. 20 min. (in one direction), we recommend not exceeding a switch-on time of 20 min.

If the summer/winter switch option has been installed, this must be switched in accordance with the time of year. The heater unit will then only switch on the vehicle fan to ventilate the vehicle interior in the position Winter  heat and in the position Summer .

Before parking the vehicle, make the following settings:

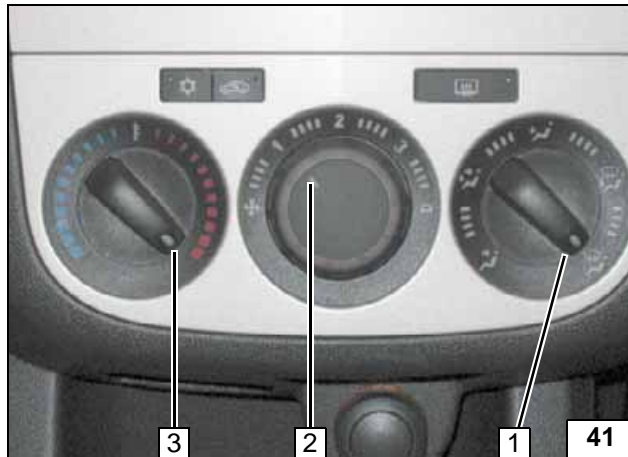

- 1 Air outlet to windshield
- 2 Set fan to level "1", or possibly "2"
- 3 Set temperature to "max."



- 1 Set temperature to "max."
- 2 Air outlet to windshield



Manual air conditioning

Automatic air-conditioning

Webasto
Feel the drive

Webasto AG
Postfach 80 - 82132 Stockdorf
Hotline 01805 / 932278 - Hotfax 0395 / 5592-353
<http://www.webasto.de>

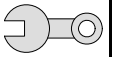

Template for Fuel Standpipe

