

Thermo Top C

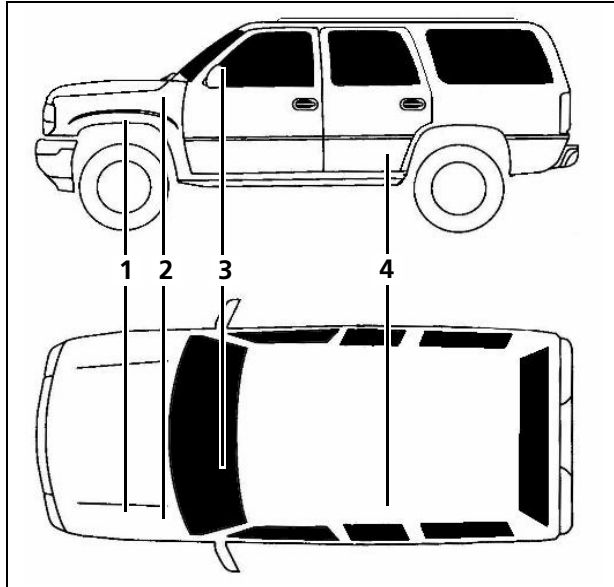

Chevrolet / Suburban / Tahoe

2003 - 2004 5.3 Liter Gasoline

Chevrolet Avalanche

2002 - 2004 5.3 Liter Gasoline

Cadillac EXT / Escalade

2002 - 2004 6.0 Liter Gasoline

GMC Yukon / Yukon XL

2003 - 2004 5.3 Liter Gasoline

Yukon Denali

2003 - 2004 6.0 Liter Gasoline

Special instructions for these models

Part locations may differ slightly dependent on the vehicle model.

Legend

- 1 BlueHeat Coolant Heater, Exhaust Muffler, and Combustion Air Intake Silencer
- 2 Fuse Holder and Resistor
- 3 Timer Control
- 4 Fuel Pump

Special Tools

- Hose Clamping pliers
- Torque Wrench (1/4' Drive)

Table of Contents

Foreword

Parts List	3	Blower Harness Configuration	9
Vehicle Information	3	Integration into Fuel System	10
Scope and Purpose	3	Heater Preparation and Installation	13
Symbol Identification	4	Combustion Air Intake and Silencer	14
General References	5	Exhaust Routing and Installation	15
Preparations	5	Integration into Coolant System	16
Heater Installation Site	5	Power Connection	18
Installation		Concluding Work	18
Electrical - Overview	6	Final Inspection and Start-up	19
Electrical Harness	7	Heater Lockout Reset Procedure	20
Heater Harness Configuration	7	Heater Plumbing Schematic - Inline Method	21



- Improper installation or repair of Webasto heating and cooling systems can cause fire or the leakage of deadly carbon monoxide leading to serious injury or death.
- Installation and repair of Webasto heating and cooling systems requires special Webasto training, technical information, special tools and special equipment.
- NEVER attempt to install or repair Webasto heating or cooling system unless you have successfully completed the factory training course and have the technical skills, technical information, tools and equipment required to properly complete the necessary procedures.
- ALWAYS carefully follow Webasto installation and repair instructions and heed all WARNINGS.
- Webasto rejects any liability for problems and damage caused by the system being installed by untrained personnel.

Foreword

Parts List

Quantity	Part	Part Number
1	Installation Kit	5000420B

Vehicle Information

Manufacturer	Model	Year	Engine Type
Chevrolet	Suburban / Tahoe	2003–2004	5.3 Liter Gasoline
Chevrolet	Avalanche	2002–2004	5.3 Liter Gasoline
Cadillac	EXT / Escalade	2002–2004	6.0 Liter Gasoline
GMC	Yukon / Yukon XL	2003–2004	5.3 Liter Gasoline
GMC	Denali	2003–2004	6.0 Liter Gasoline

This installation requires special expertise from a Webasto training course to install a Webasto Thermo Top C/Z, which means that it may only be installed by a specially trained workshop or dealership. Webasto cannot accept any liability for faults and damage caused by the system being installed by untrained personnel.

Scope and Purpose

These non-binding installation instructions are intended to support authorized Webasto trained distributors, dealers and personnel in the installation of the Thermo Top C/Z and BlueHeat Coolant Heaters.

These non-binding installation instructions apply to the vehicles listed on the front cover of this installation document unless technical modifications on the vehicle influence the installation, excluding all liability claims. Depending on the version and equipment in the vehicle, changes may be required to the installation work set out in these installation instructions. In any event, however, the directives in the “installation manual” and “operating manual” Thermo Top C/Z must be followed. Acknowledged engineering conventions must be observed for the installation work.

CAUTION

Location of heater, installation of coolant lines, fuel system and components, wiring and control devices are important for proper operation. Failure to comply with the installation instructions provided may result in poor operation or damage to heater and vehicle components.



ATTENTION

All relevant state and provincial licensing regulations if any, governing the installation and use of auxiliary heating devices must be observed!



Symbol Identification

Symbols that define sections in manual



Mechanical Preparation



Fuel



Electrical



Exhaust



Coolant



Combustion Air Intake

General Symbol Descriptions



Warning



Refer to Webasto or Manufacturer Manual



Caution



Attention



Flammable or Combustible

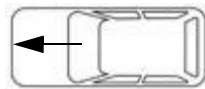

Part Location on Vehicle

General References

- Bare body parts, for example around drilled holes, must be treated with anti-corrosive coating.
- Secure hoses, cables and wiring harnesses with cable ties and fit protective hoses around them at chafing points.
- Fit edge protectors (opened fuel hose) to sharp edges.

Preparation

Heater Kit

- Verify and identify all contents of kit.

Vehicle

- Verify fuel content in tank.

CAUTION

For reasons of safety due to the possibility of fuel spillage during the installation of a fuel standpipe, it is recommended there be no more than 1/4 tank of fuel present. If fuel quantity is greater than 1/4 of capacity, make provisions to reduce quantity of fuel.



Heater Installation Site

ATTENTION

The Webasto Auxiliary Coolant Heater is to be mounted to the lower fender support bracket near right rear of vehicle bulkhead as shown.

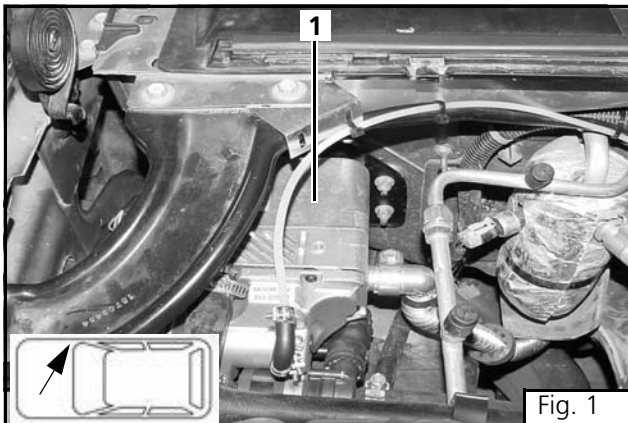

- (1) Webasto Auxiliary Coolant Heater Mounting Location



Installation

Electrical - Overview

ATTENTION

The timer control location is a recommendation only. Please consult with the customer before mounting.



Vehicle HVAC Blower Motor

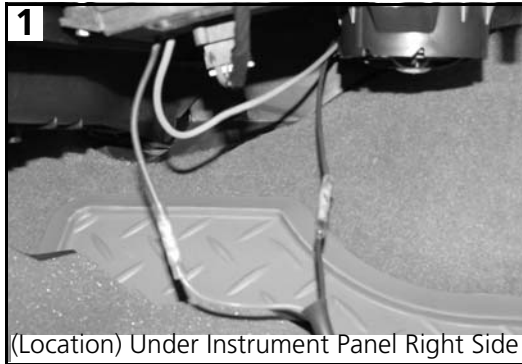

Timer Control Location

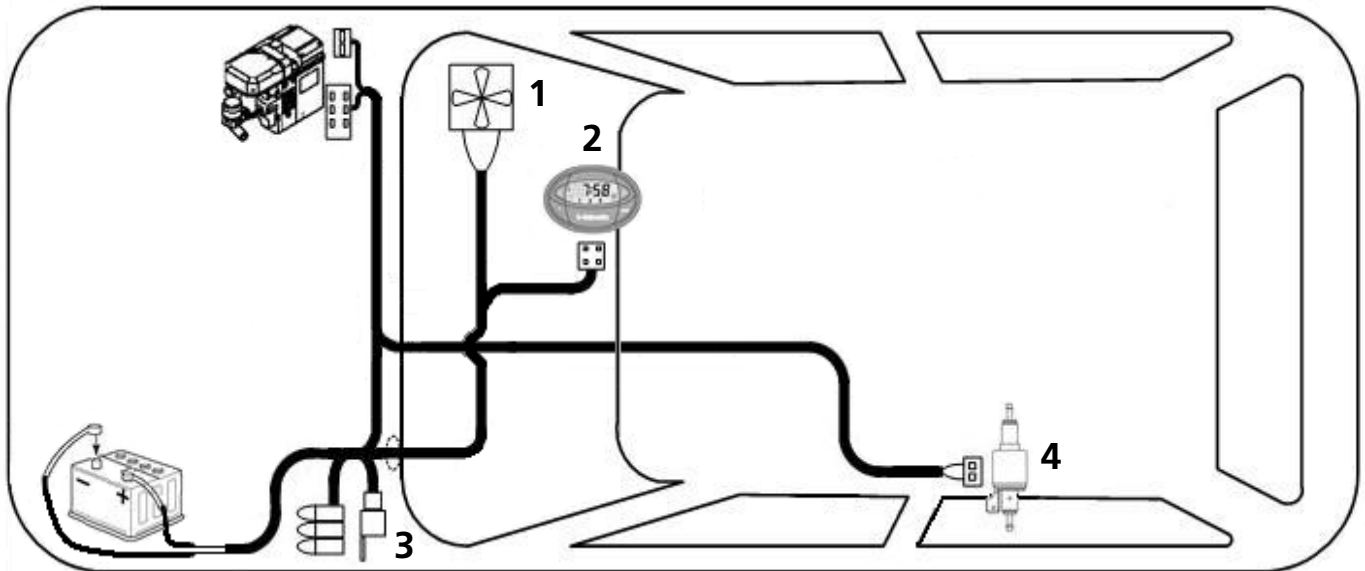

Webasto Blower Relay

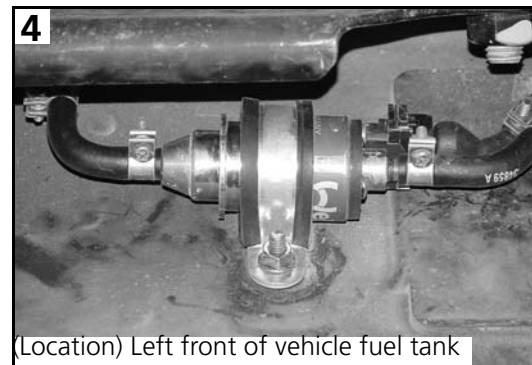

Webasto Heater Fuel Pump

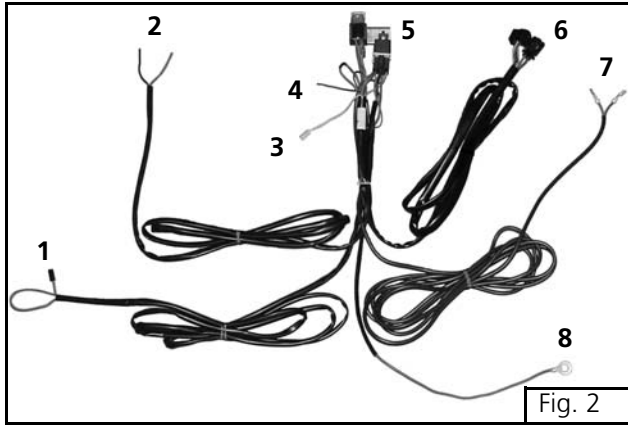

Fig. 2

Electrical Harness

ATTENTION

The harness provided is designed for dual purpose. It can be configured for either manual or automatic dual-zone climate control (HVAC) option offered on current GM vehicles. Determine vehicle system requirements and configure the harness accordingly.

- (1) To Timer & Optional Remote
- (2) To Blower Motor Fuse
- (3) Diagnostic Connector (Unused)
- (4) Supplemental Heat Connection (Option)
- (5) Fuse Block (under hood location)
- (6) To Heater
- (7) To Fuel Pump
- (8) To Power Source



Heater Harness Configurations

Manual Dual-Zone Climate Control

ATTENTION

Remove the brown pig-tail with eyelet from the resistor and connect the red wire from the fuse block. The brown wire is not used in this configuration.

- (1) Brown Wire with Eyelet.
- (2) Red Wire from Fuse Block

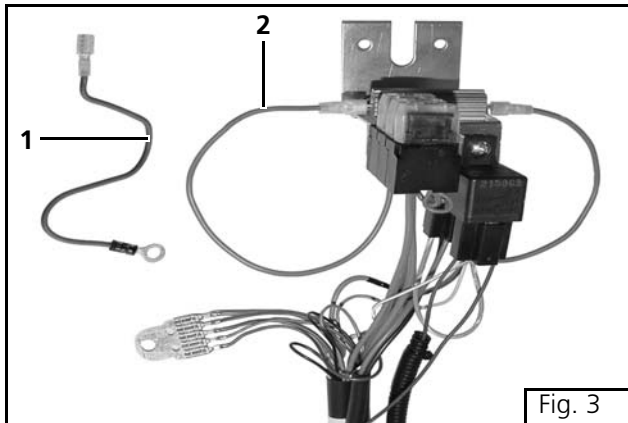

Fig. 3

Automatic Dual-Zone Climate Control

ATTENTION

With brown pig-tail connected to resistor, connect eyelet to an existing ground point. The red wire from the fuse block is not used in this configuration. Remove fuse.

- (1) Brown Wire with Eyelet
- (2) Red Wire from Fuse Block

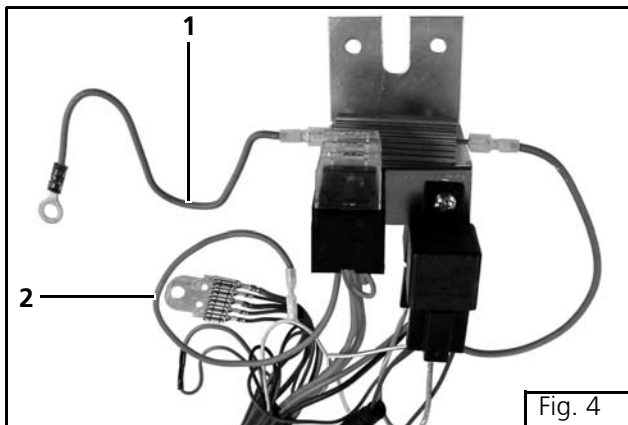
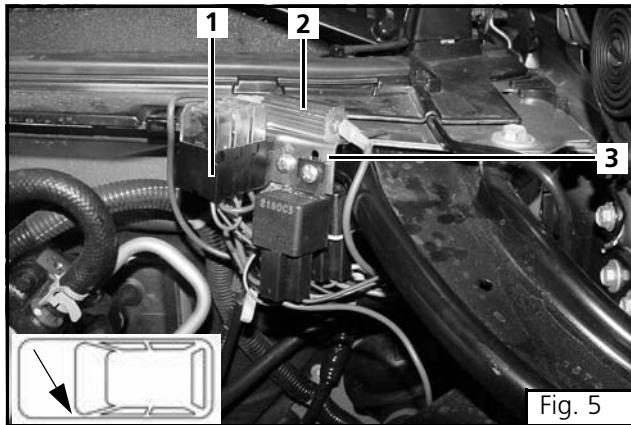

Fig. 4



ATTENTION

Mount ground splice plate to an available ground stud on bulkhead.

- (1) Webasto Fuse Block
- (2) Resistor
- (3) Fuse Block, Resistor, Relay Bracket

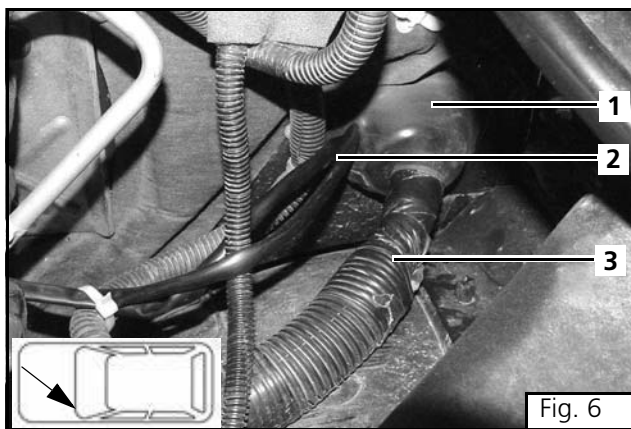

ATTENTION

Route Blower and Timer Harnesses into vehicle by cutting a 1 in. slit in left side of bulkhead grommet.

- (1) Bulkhead Grommet
- (2) Blower and Timer Harness
- (3) Vehicle Harness

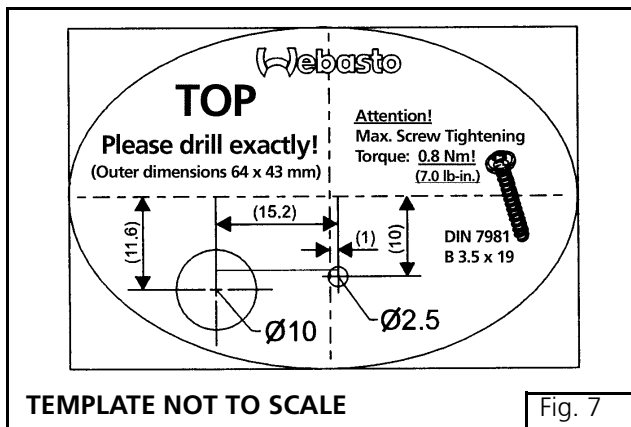

CAUTION

Before drilling into any panels, ensure there are no hidden components behind the panel that may be damaged or interfere with the timer installation!

ATTENTION

Before installing the timer, please confirm the installation site with your customer.

ATTENTION

DO NOT OVER TIGHTEN MOUNTING SCREW! Maximum torque - 0.8 Nm (7.0 lb-in.).

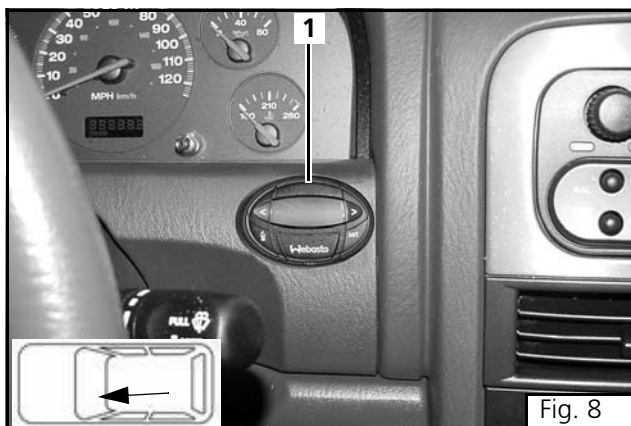

- (1) Timer Control (Mounting example only)



Blower Harness Configurations

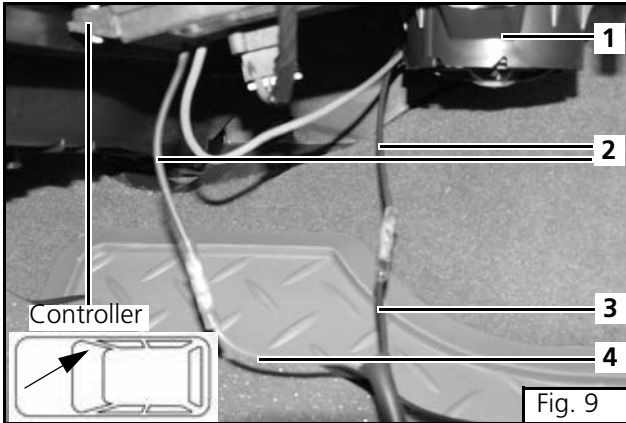

**Manual Dual-Zone Climate Control
(Refer to Fig. 9)**

- (1) Blower Motor
- (2) Purple (or Red) Wire from Controller to Blower Motor. (Cut Mid Way)
- (3) Black Wire from Webasto Harness
- (4) Red Wire from Webasto Harness

**Automatic Dual-Zone Climate Control
(Refer to Fig. 9)**

- (1) Blower Motor
- (2) Black Wire from Controller to Blower Motor. (Cut Mid Way)
- (3) Black Wire from Webasto Harness
- (4) Red Wire from Webasto Harness

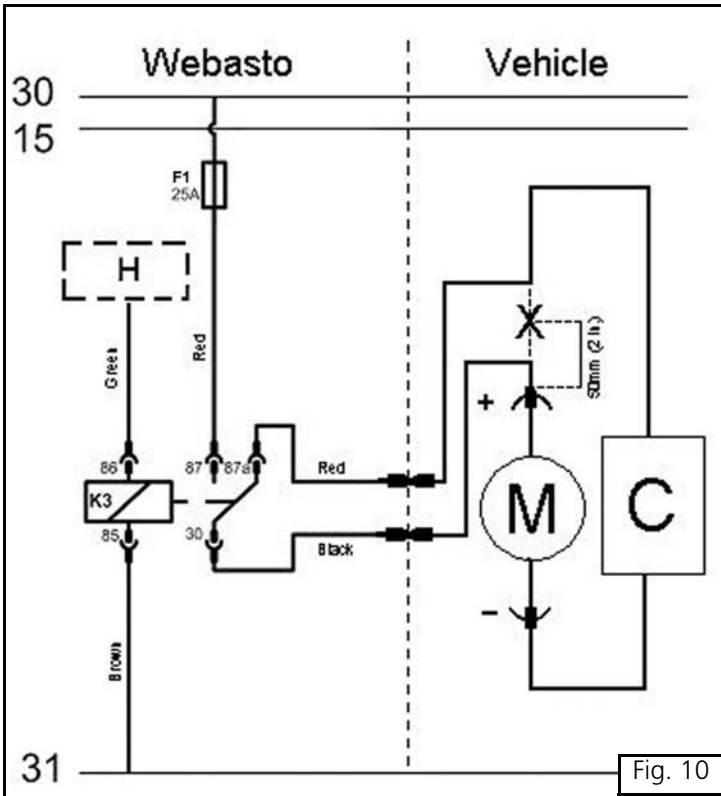

ATTENTION

Check your wiring! Ensure that all connections have been done in accordance with the wiring diagram shown (Fig. 10). Sensitive electronic controls can be damaged if wired incorrectly!

ATTENTION

Secure HVAC blower control wiring to vehicle structures with nylon wire ties (Image not available)



Legend for Figure 10

- C HVAC Control Module
- M HVAC Blower Motor
- X Cut wire at 50 mm (2 in.) from motor
- H Webasto Heater
- F1 Fuse - Blower Circuit 25 Amp
- K3 Relay
- 30 Battery Positive (Constant Power)
- 15 Ignition Power (Switched Power)
- 31 Battery Negative (Chassis Ground)



Integration into Fuel System

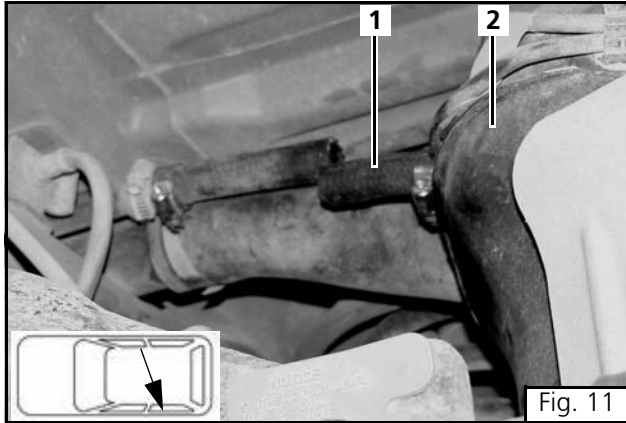

ATTENTION

Cut vent tube 2 1/2 inches from vehicle fuel tank.

Be sure to remove the metal mesh screen found at the entrance to the fuel tank prior to standpipe installation.

- (1) Fuel Filler Vent Tube
- (2) Vehicle Fuel Tank

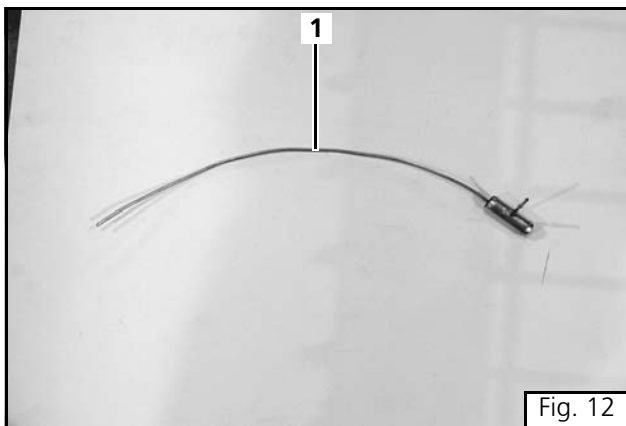

ATTENTION

Cut stand pipe to a length of 18 1/2 inches and form standpipe as shown.

- (1) Webasto Standpipe Assembly

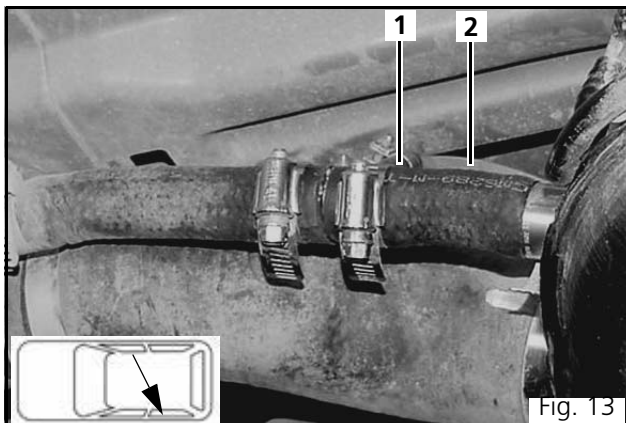

ATTENTION

Ensure standpipe is routed around fuel tank baffling (dividers) and that the end of the standpipe reaches the bottom most area of the fuel tank to allow for proper fuel flow.

Position nozzle on standpipe to face towards outboard driver side of vehicle, angled above fuel filler hose.

- (1) Standpipe Nozzle
- (2) Webasto Fuel Line

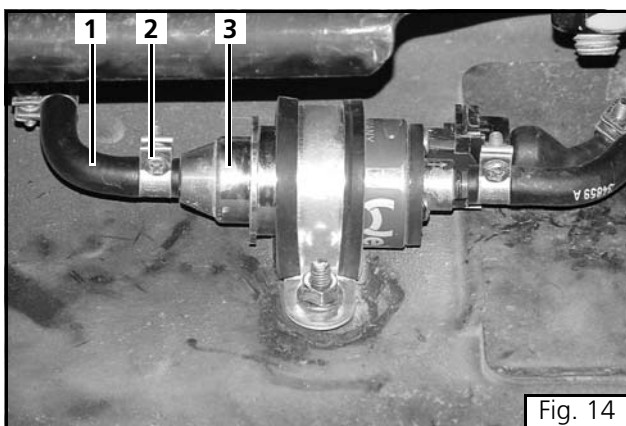

CAUTION

Always cut fuel line with a sharp razor knife or razor. DO NOT cut with side cutters, scissors, or similar tools as doing so will cause a restriction inside the fuel line.

- (1) 90 Degree Fuel Line Connector
- (2) Hose Clamp
- (3) Webasto Fuel Pump



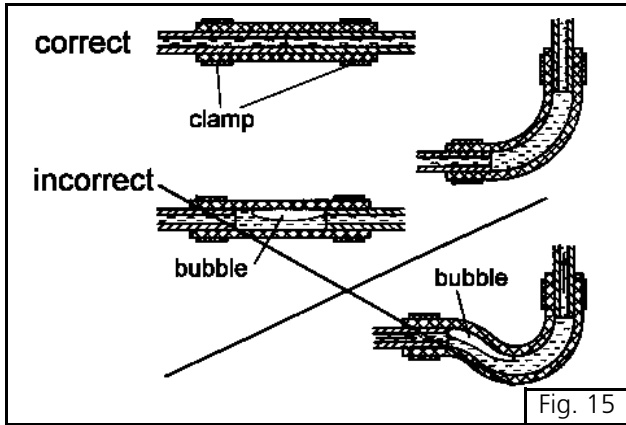

Fig. 15

ATTENTION

Ensure the fuel lines are fully seated within the line connectors and any 90 degree bends are not buckled. Refer to fig. 15.

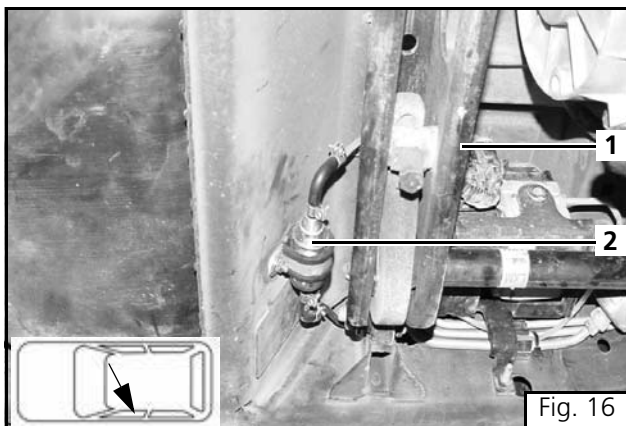

Fig. 16

ATTENTION

Route heater fuel line (connected from fuel standpipe) over fuel tank and over vehicle cross member for installation to fuel pump.

- (1) Torsion Bar Cross Member
- (2) Webasto Fuel Pump

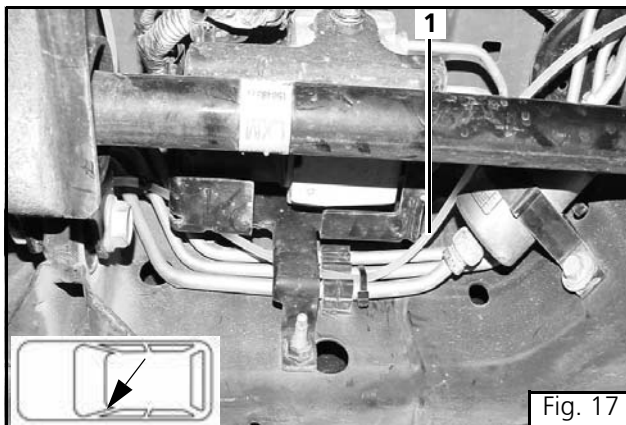

Fig. 17

ATTENTION

Route fuel line from fuel pump outlet along existing fuel lines to heater location.

- Webasto Fuel Line

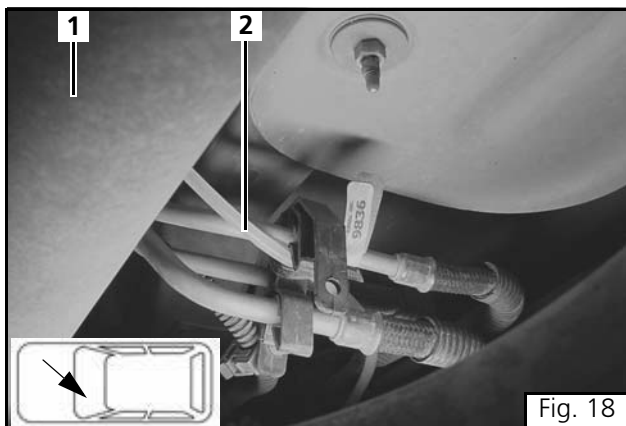
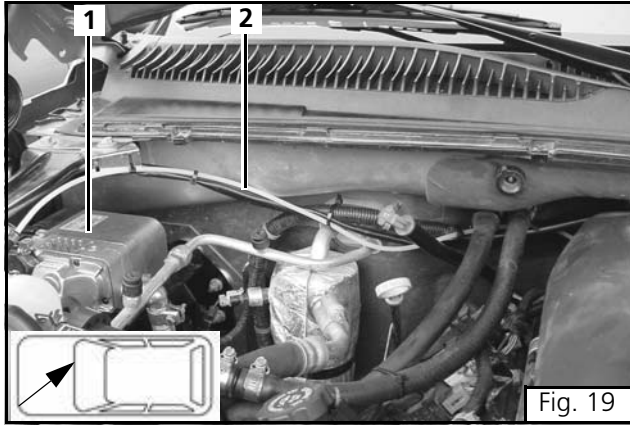

Fig. 18

- (1) Front Driveshaft
- (2) Webasto Fuel Line



ATTENTION

Protect fuel line from damage and chafing where necessary by securing with nylon ties or covering with loom in vulnerable areas.

- (1) Webasto Coolant Heater
- (2) Fuel Line Routing





Heater Preparation and Installation

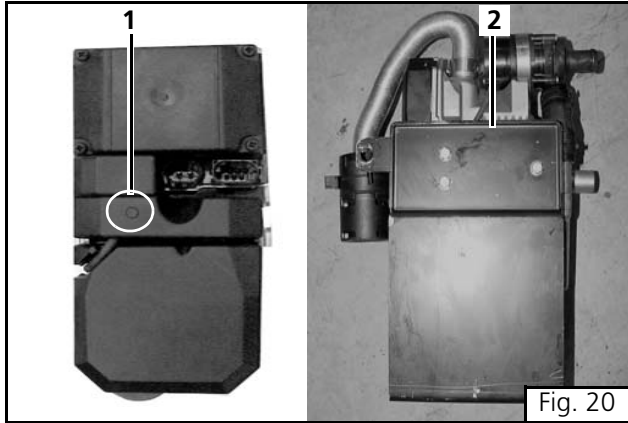

ATTENTION

Remove knock out on heater cover as shown

- (1) Circular Heater Knock Out
- (2) Bracket Mounted to Heater

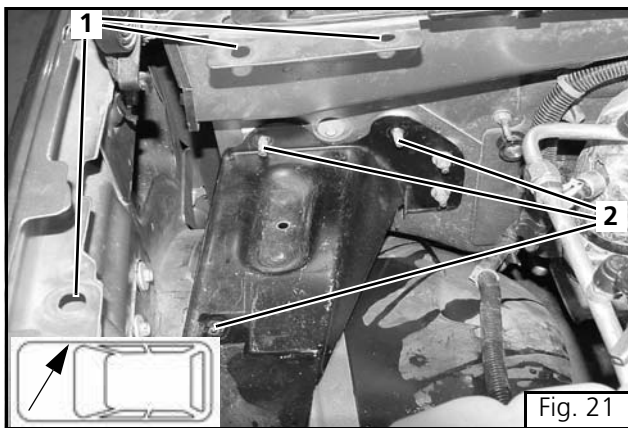

ATTENTION

Mount heater to bracket assembly and install on vehicle using exiting retaining nuts and studs.

- (1) Upper Fender Bracket Retaining Bolts Removed
- (2) Lower Fender Bracket Retaining Nuts Removed

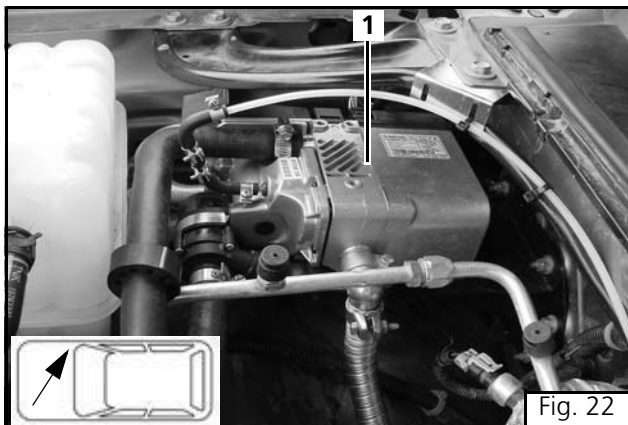

- (1) Webasto Coolant Heater Installed

Connecting the Fuel Line to Heater

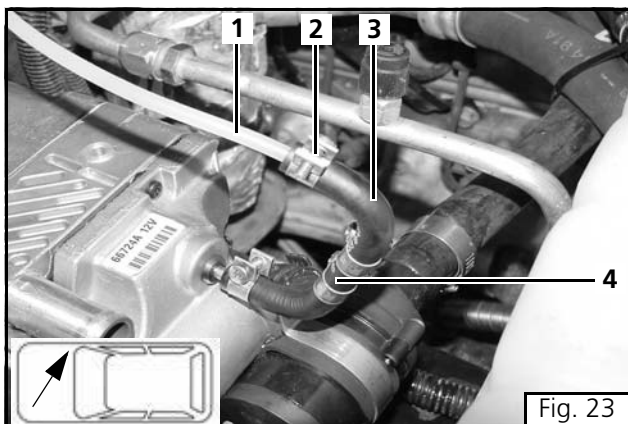

- (1) Webasto Fuel Line
- (2) Hose Clamp
- (3) 90 Degree Fuel Hose Fitting
- (4) Hose Connector



Combustion Air Intake and Silencer

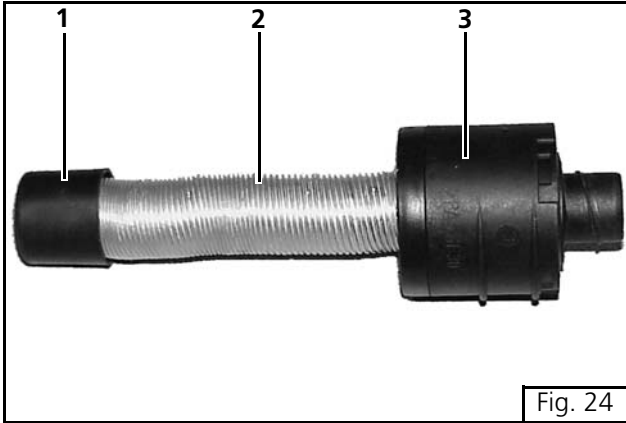

- (1) Combustion Intake Tube End
- (2) Combustion Air Intake Tube
- (3) Air Intake Silencer

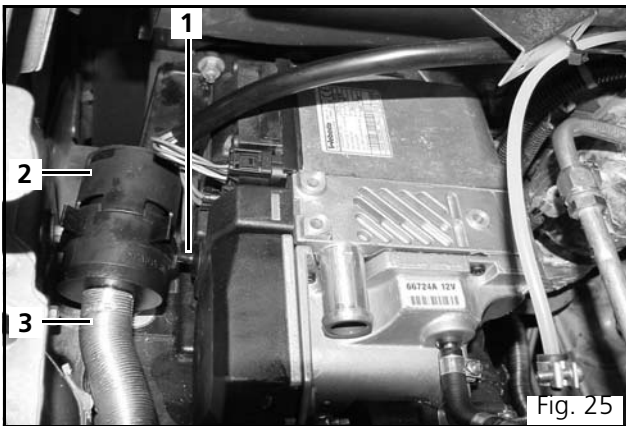

ATTENTION

Cut air intake tube to 11 inches. Mount air intake silencer and combustion air intake tube to heater using knock out (previously removed) from heater cover.

- (1) Combustion Air Intake Mounting Location
- (2) Air Intake Silencer
- (3) Air Intake Tube



Exhaust Routing and Installation

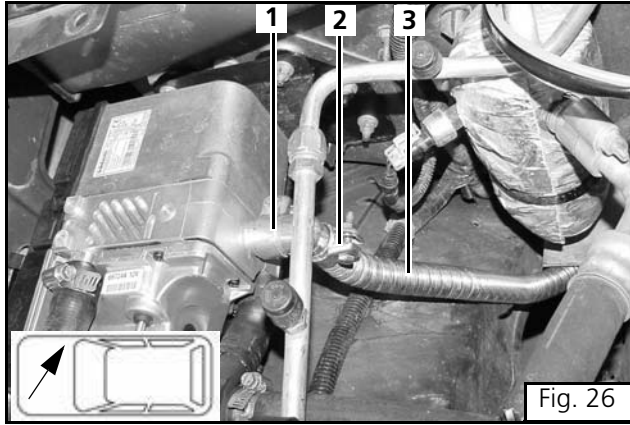

ATTENTION

Install heat insulating sleeve (not shown) over exhaust pipe and route to underside of vehicle as shown.

- (1) 90 Degree Exhaust Fitting
- (2) Exhaust Clamp
- (3) Exhaust Tube

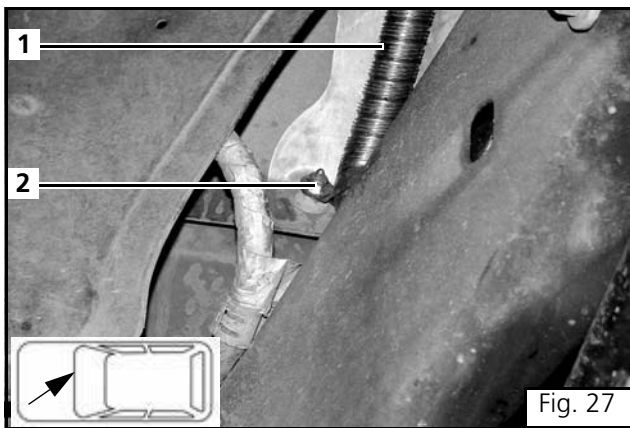

ATTENTION

Use an exhaust P-clamp and nut to attach exhaust pipe to base of A/C accumulator drip shield as shown.

- (1) Exhaust Tube
- (2) Mounting Location

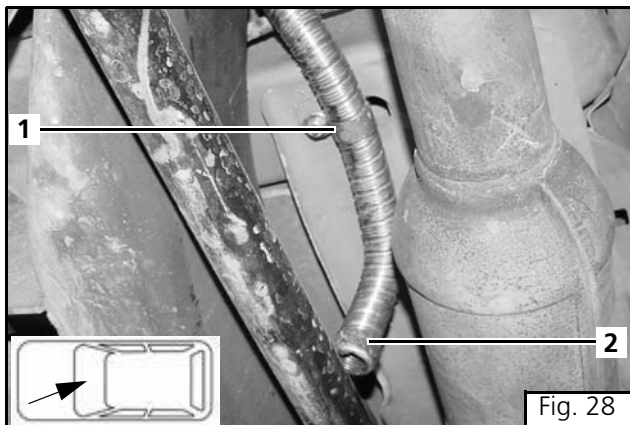

ATTENTION

Ensure that heat insulators are properly placed (if used) and that the tail pipe is positioned downward.

- (1) Exhaust Clamp
- (2) Exhaust Tailpipe





Integration into Coolant System

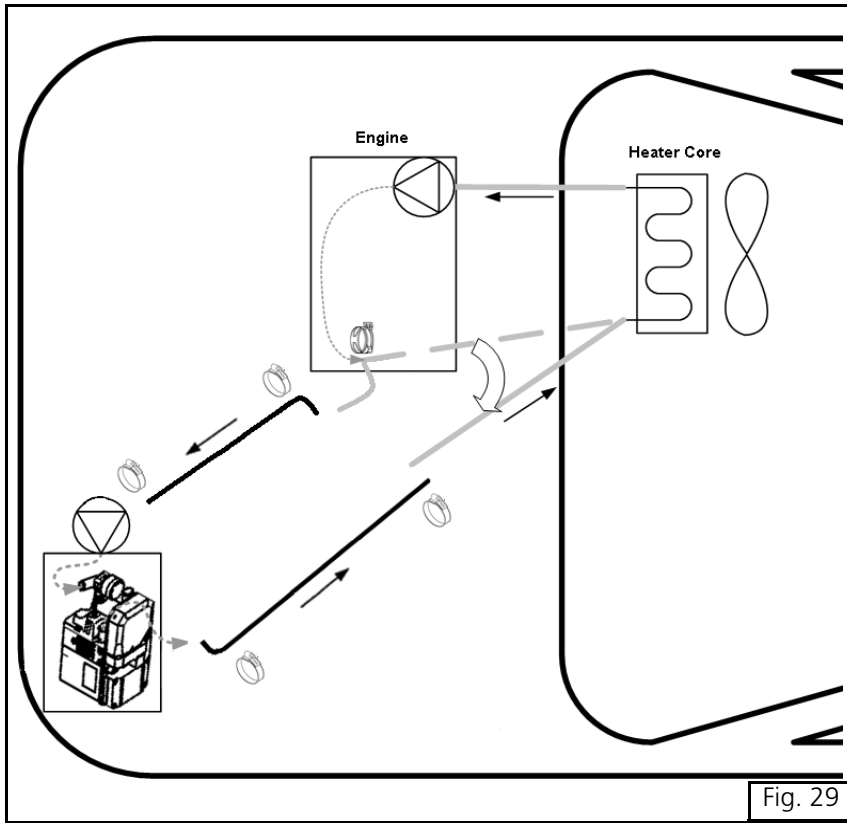

Fig. 29

ATTENTION

Fig. 29 displays the integration of the Webasto Coolant Heater into the vehicles cooling system.

ATTENTION

Torque all hose clamps to 2.0 - 2.5 Nm (18 - 22 lb.-in.).

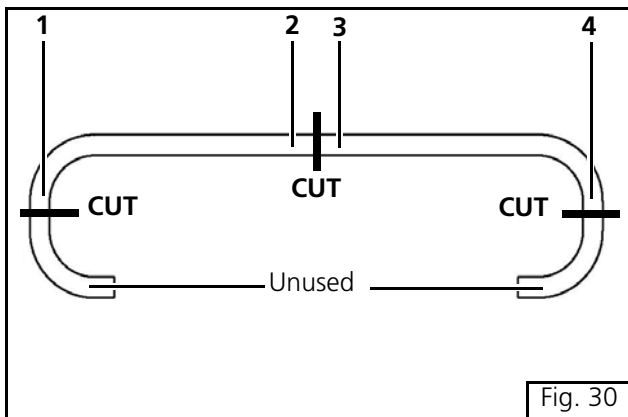

Fig. 30

ATTENTION

Cut provided coolant hose according to fig. 30.

- (1) Connect to Outlet Side of Webasto Heater.
- (2) Connect to Heater Core Inlet Hose
- (3) Connect to Inlet Side of Webasto Heater
- (4) Connect to Engine Side of Cut Hose.

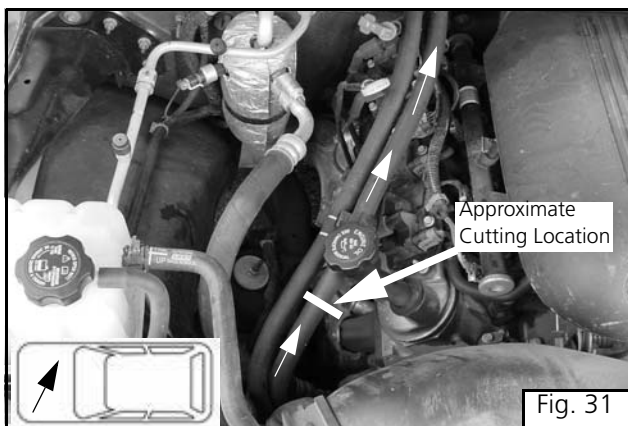
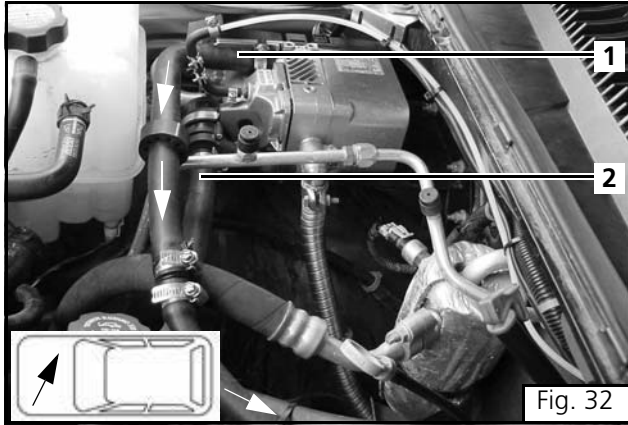

Fig. 31

ATTENTION

Cut vehicle heater core inlet hose 18 inches from bulkhead as shown.





- (1) Webasto Heater Outlet Hose
- (2) Webasto Heater Inlet Hose

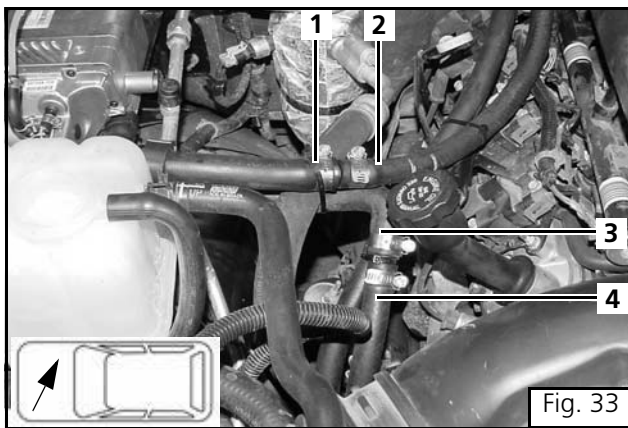

ATTENTION

Secure coolant lines to available components with nylon wire ties. Keep lines away from hot exhaust and turbo components.

- (1) Webasto Heater Outlet Hose
- (2) Heater Core Side Inlet Hose
- (3) Webasto Heater Inlet Hose
- (4) Engine Side of Heater Core Inlet Hose

NOTE:

Also see the plumbing schematic in the back of this manual for a general outline of the coolant circuit arrangement.





Power Connection

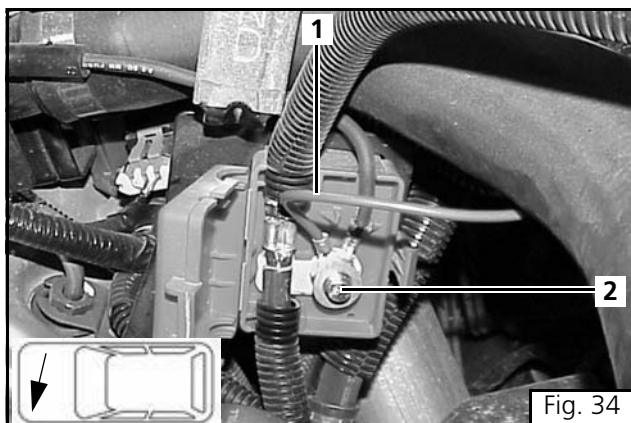

Fig. 34

ATTENTION

Connect red power lead to existing power stud underhood. Reconnect battery ground cable.

- (1) Webasto Power Lead
- (2) Vehicle Power Stud



Concluding Work

- Install all vehicle parts, panels and components removed during heater installation.
- Check that all hose lines, hose clamps, pipe clips and electrical connections are secure.
- Secure all loose lines and cables with nylon cable ties.
- Spray the heater components and electrical connections with an anti-corrosive wax coating.



Final Inspection and Initial Start-up

Final Inspection

Inspect installation for:

- Loose fasteners.
- Exhaust system routing and clamp tightness.
- Combustion air intake tube routing and clamp tightness.
- Loose coolant line clamps.
- Pinched coolant lines.
- Routing of coolant lines and coolant lines securely tied and protected against chafing and related damage.
- Loose fuel line clamps.
- Routing of fuel lines and fuel lines securely tied and protected against chafing and related damage.
- Loose wiring connections and battery connections.
- routing of wiring harness and wiring harness securely tied and protected against chafing and related damage.
- Check operation of vehicle heater fan with Webasto heater OFF.

Initial Start-up

1. Top off cooling system with coolant per engine/vehicle manufacturers recommendations.
2. Set interior heater control to maximum heat position (hot) and switch off air conditioning system.
3. Start the vehicle engine and run on fast idle for 5 minutes to purge any remaining air from the Webasto heater and coolant system. While the engine is running check:
 - Hose connections for leaks.
 - Coolant level in expansion tank. (Add coolant as needed)
4. Switch off the engine.



ATTENTION

More than one start-up attempt of the heater may be required to purge air from fuel system before heater will start. Cycle heater Off and On after each failed start attempt until heater starts successfully. After 3 consecutive unsuccessful start attempts, the webasto control unit enters into Heater lockout. See Heater Lockout section for reset instructions.



5. Switch on the Webasto heater by means of the instant heat button on timer and check:
 - Timer panel and instant heat indicator illuminates.
 - Circulating pump in operation.
 - Initiation of start-up sequence.
 - Successful start-up and operation.
6. Allow heater to run for 20 minutes or until coolant is heated to temperature. Re-tighten all hose clamps.

ATTENTION

Engine coolant temperature gauge may read lower than actual Webasto heater output temperature. This is due to the location of the temperature gauge sensor on engine.





Heater Lockout Reset Procedure

The BlueHeat is designed with a lockout safety feature built into the control unit. After 3 consecutive unsuccessful startup attempts, the heater will lock itself out from any further start attempts. The heater may also enter the lockout mode after experiencing an overheat condition.

Reset Heater "Lockout" mode by performing the following procedure:

1. Ensure timer or switch is in the "OFF" position. Turn timer or switch to the "On" position. Remove main fuse F2 (20 Amp), reinsert after 5 seconds.
2. Cycle timer or switch off and then back on once more. Remove fuse F2 once again and reinsert after 5 seconds. Heater should attempt to start after inserting fuse.

ATTENTION

- Coolant temperature must be below the lower threshold before heater will attempt to start.
- The engine coolant must reach 86 °F (30 °C) before the Webasto heater will attempt to start vehicles blower fan.
- Should the heater fail to start or operate correctly, call your Webasto technical representative at:
1-800-555-4518





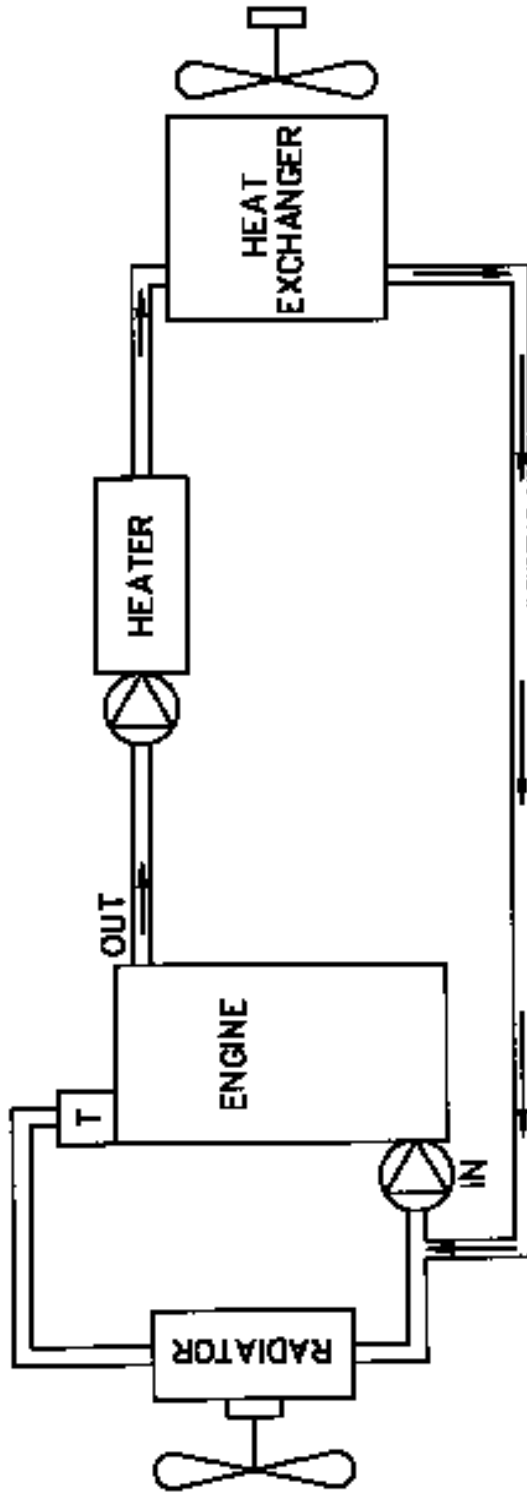

Heater Plumbing Schematic - Inline Method

WEBASTO THERMO TOP C INLINE COOLANT SCHEMATIC



 = THERMOSTAT

 = COOLANT PUMP (2 PLC'S)



Webasto Product N.A., Inc.

Technical Assistance Hotline

USA: (800) 555-4518

Canada: (800) 667-8900