

# Water heater



*Feel the drive*

***Thermo Top C***  
**Auxiliary heating system**

  
00 0002

## Installation Instructions

### Suzuki Grand Vitara

Petrol  
From model 2006  
Left-hand drive models only



#### **IMPORTANT!**

#### **Danger warning:**

**The incorrect installation or repair of Webasto heating systems may cause a fire or the escape or fatal carbon monoxide. This may result in serious or fatal injuries.**

**Special company training, technical documentation, special tools and special equipment are required for the installation and repair of Webasto heating and cooling systems.**

**NEVER attempt to install or repair Webasto heating or cooling systems unless you have completed the company training and thus acquired the required technical skills and unless you have the technical documentation, tools and equipment available to you that are required for completing proper installation and repair work.**

**ALWAYS follow all Webasto installation and repair manuals and observe all the warnings.**

**Webasto cannot accept any liability for defects and damage caused by the system being installed by untrained personnel.**

## Table of contents

|   |    |   |    |
|---|----|---|----|
| Validity                                  | 2  | Prepare heater                              | 12 |
| Heater / installation kit                 | 3  | Install heater                              | 13 |
| Foreword                                  | 3  | Exhaust system                              | 14 |
| General                                   | 3  | Integration in fuel system                  | 16 |
| Special tools                             | 3  | Water connections                           | 20 |
| Notes on document                         | 4  | All vehicles                                | 20 |
| Preparations                              | 5  | Only for 1.6 petrol                         | 21 |
| Installation site for the heater          | 5  | Only for 2.0 petrol                         | 21 |
| Electrical connections                    | 6  | All vehicles                                | 22 |
| Automatic air-conditioning blower control | 7  | Combustion air                              | 23 |
| Option Telestart                          | 9  | Completion                                  | 24 |
| Option Thermo Call                        | 10 | Operating instructions for the end customer | 25 |
| Prepare installation site                 | 11 | Tank connector template                     | 26 |

## Validity

| Manufacturer | Trade name   | Type | EC licence no. / General operating permit (homologation) |
|--------------|--------------|------|--|
| Suzuki       | Grand Vitara | JB   | e4*2001/116*0091...                                      |

| Engine type | Engine type | Output in kW | Swept volume in cm <sup>3</sup> |
|-------------|-------------|--------------|---------------------------------|
| J20A        | Petrol      | 103          | 1995                            |
| M16A        | Petrol      | 78           | 1586                            |

The vehicle types, engine types and equipment versions not listed in these installation instructions have not been tested. It may nevertheless be possible to install the system using these installation instructions.

The installation site for the digital timer and summer / winter switch should be agreed with the end customer before installation!

## Heater / installation kit

| Quantity | Designation  | Order No. |
|----------|--|-----------|
| 1        | Kit includes Thermo Top C petrol without digital timer | 93001B    |

### optional control element as required:

| Quantity | Designation   | Order No. |
|----------|---------------|-----------|
| 1        | Digital timer | 9005753C  |
| 1        | Telestart T80 | 9007098A  |

### additionally:

| Quantity | Designation                          | Order No. |
|----------|--------------------------------------|-----------|
| 1        | Installation kit Suzuki Grand Vitara | 1310357A  |

## Foreword

These installation instructions apply to vehicles with Suzuki Grand Vitara with Petrol engines (see page 2 for validity) model year 2006 and later, unless technical modifications on the vehicle influence the installation, excluding all liability claims. Depending on the version and equipment in the car, changes may be required to the installation work set out in these "installation instructions".

In any event, however, the directives in the "installation instructions" and "operating and servicing instructions" for the *Thermo Top C* must be followed.

The appropriate engineering conventions and any instructions from the vehicle manufacturer must be observed for the installation work.

## General

Installation is carried out in accordance with general technical principles. Unless indicated otherwise in the description, secure onto the hoses, cables and wiring harnesses using cable ties.

Fit a chafe guard over sharp edges (fuel hose cut open)!

Spray bare body parts, for example around drilled holes, with anti-corrosive wax (Tectyl 100K, order No. 111329).

## Special tools

- Torque wrench for 2.0 – 10 Nm
- Clamping claw
- Rivet nut pliers

## Notes on document

To give you a quick overview of the various procedures, you will find an identifier on the outside edge at the top right on the appropriate page.

### Mechanics

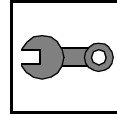

### Electrics

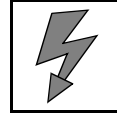

### Water connections

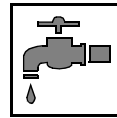

### Fuel connections

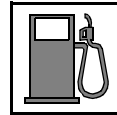

### Exhaust system

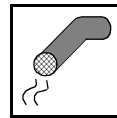

### Combustion air

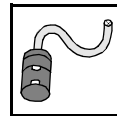

Special features are identified by the following symbols:



Specific danger of serious or fatal accidents



Specific danger of damaging components



Specific fire and explosion hazard



Reference to general installation instructions for Webasto components and to documents specific to the vehicle supplied by the manufacturer



Note to a technical peculiarity

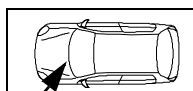
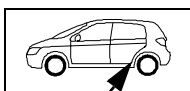

The arrow in the vehicle icon points to the position in the vehicle and indicates the viewing direction

## Preparations

### IMPORTANT!

- Drain the vehicle tank for removal according to the manufacturer's instructions
- Disconnect the battery!
- Release the pressure from the cooling system!
- Transfer the factory number from the original rating plate to the duplicate rating plate
- Remove the inapplicable year number from the duplicate plate
- Fit the duplicate plate (model plate) in a suitable position where it is visible
- Completely remove the battery
- Remove the battery tray
- Remove the complete air filter and the intake hose
- Open the tank cover and vent the tank
- Close the tank cover again
- Remove the tank as instructed by the manufacturer
- Remove the tank fittings as instructed by the manufacturer
- Remove the air-conditioning control
- Remove the bottom footwell cover on the driver side (only with Thermo Call)
- Remove the bottom footwell cover on the passenger side
- Remove the A-pillar trim on the passenger side (only with Telestart and/or Thermo Call)

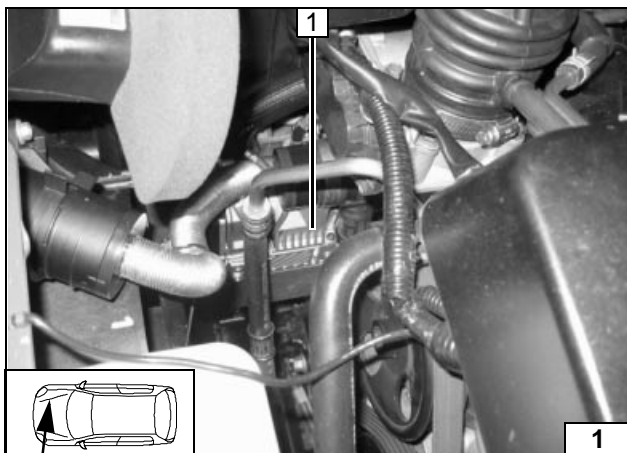

### Installation site for the heater

1 Heater

Installation  
position



## Electrical connections

### Wiring harness passage

- 1 Rubber grommet

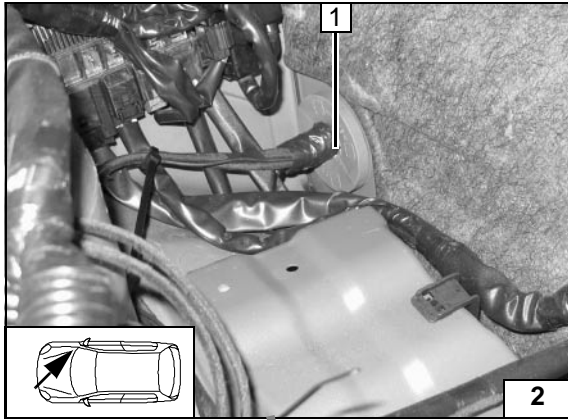

### Digital timer

- 1 Digital timer

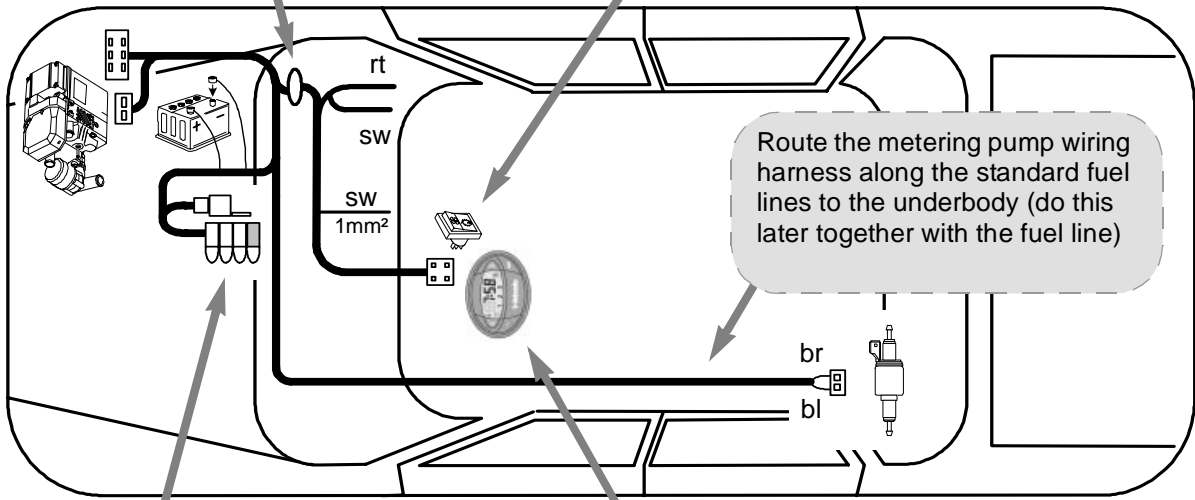
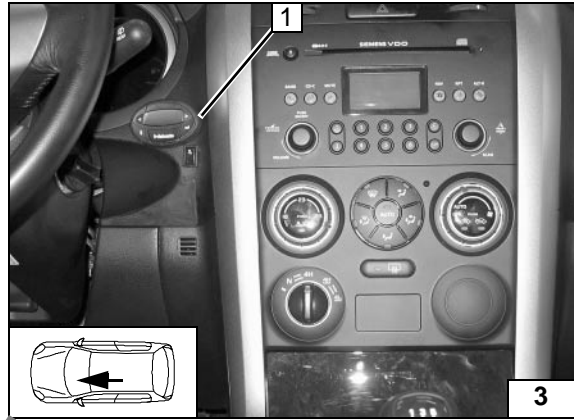
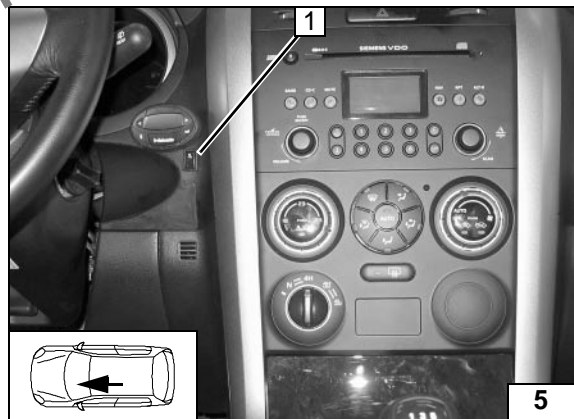
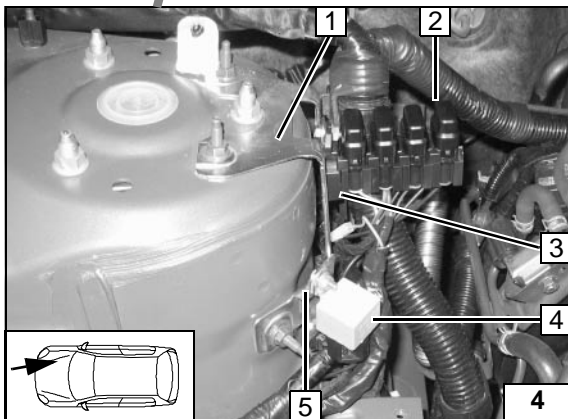

Diagram for routing wiring harness



### Fuse holder, K3 relay

Consult circuit diagram page 8!

- 1 Standard cable holder
- 5 Remove cable from holder and secure with cable tie (only 1.6 petrol), bend lug
- 4 K3 relay, screw M5x12, washers, nut M5
- 3 Fuse holder
- 2 Fuse holder, screw M5x12, washers, nut M5

### Optional summer/winter switch

- 1 Summer/winter switch, hole diameter 12 mm

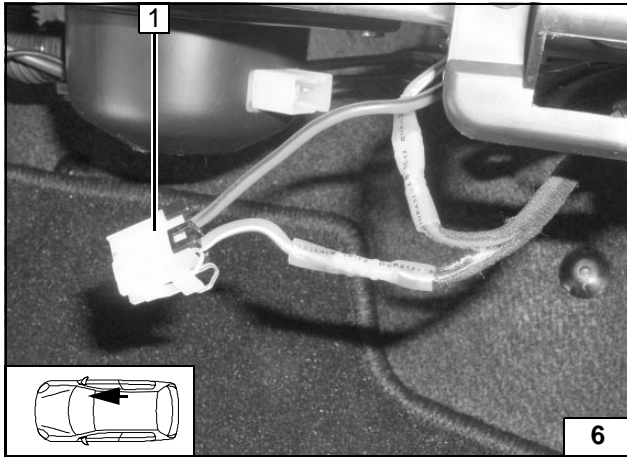

## Automatic air-conditioning blower control

Connection to the 2-pin plug of the blower motor.  
Make the connections using the supplied butt connectors as shown in the circuit diagram.

- 1 Plug 2-pin

Connection to blower motor

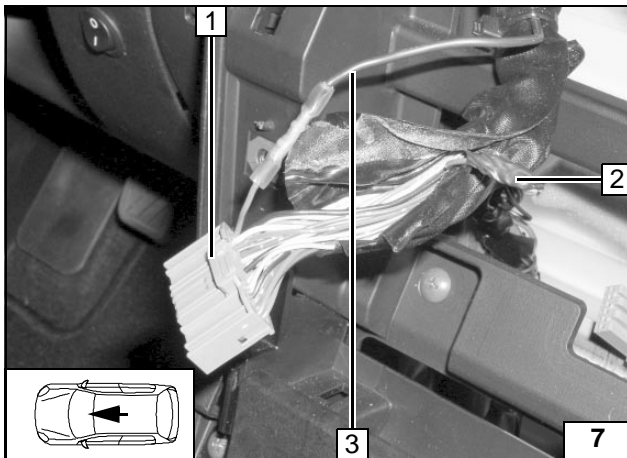

Connection to the 32-pin plug G52 grey of the air-conditioning control.  
Make the connections using the supplied butt connectors as shown in the circuit diagram.

- 1 Plug G52 grey
- 2 Standard violet/red cable insulated
- 3 Cable black 1 mm<sup>2</sup> F4

Connection air-conditioning control

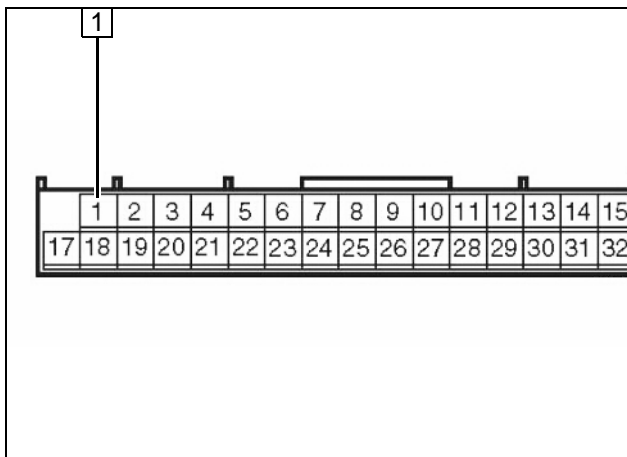

- 1 Plug G52 pin1

Plug air-conditioning control

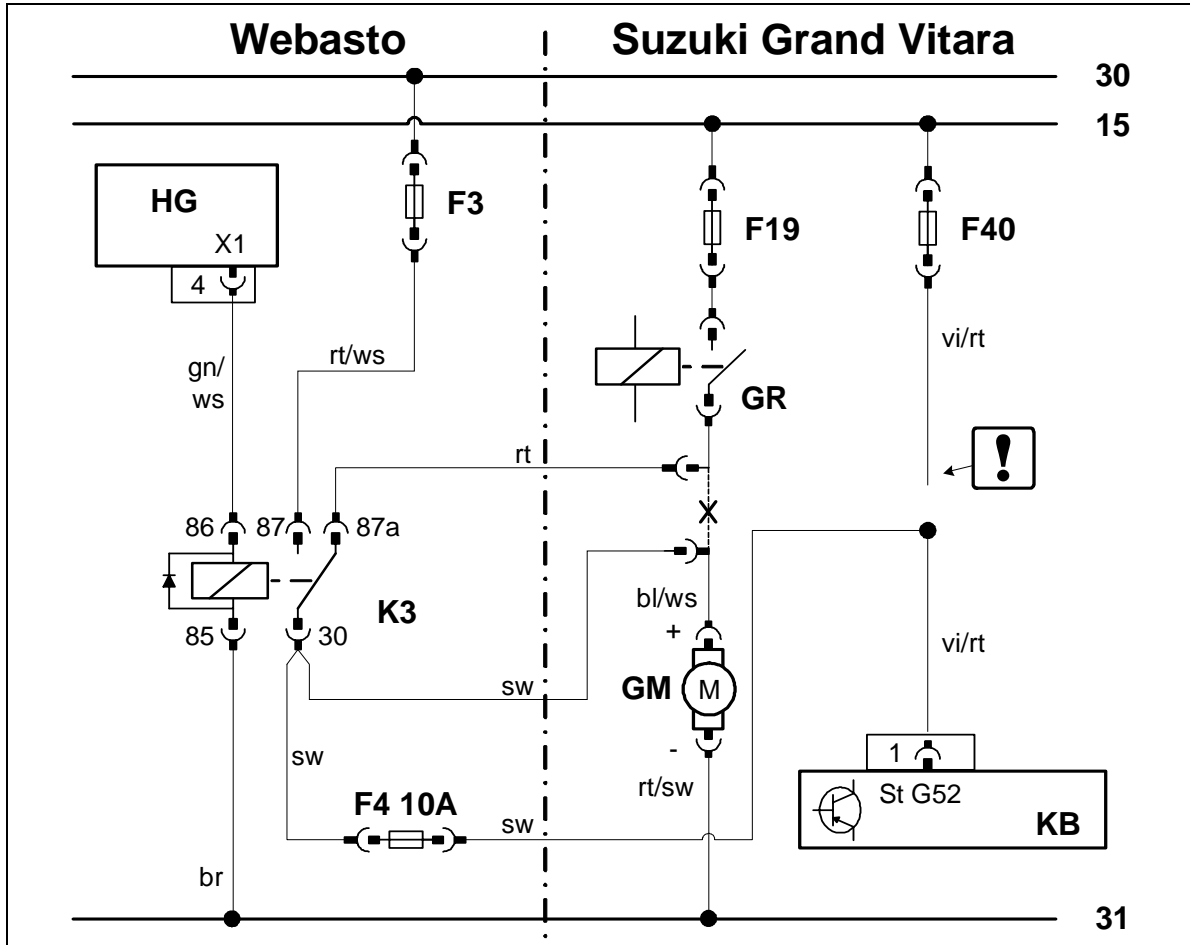

Circuit diagram of automatic air conditioning system

| Webasto components |               | Components Suzuki |                          | Colours and symbols |   |
|--------------------|---------------|-------------------|--------------------------|---------------------|---|
| HG                 | Heater TT-C/E | GM                | Blower motor             | rt                  | red   |
| F3                 | Fuse          | GR                | Blower relay             | ws                  | white   |
| K3                 | Blower relay  | F19               | Fuse                     | sw                  | black   |
| F4                 | Fuse 10A      | F40               | Fuse                     | br                  | brown   |
|                    |               | KB                | Air-conditioning control | gn                  | green   |
|                    |               | G52               | Plug 32-pin              | bl                  | blue  |
|                    |               |                   |                          | vi                  | violet  |
|                    |               |                   |                          |                     | Insulate ends of cables and secure out of the way |
|                    |               |                   |                          | X                   | Cut   |

Key



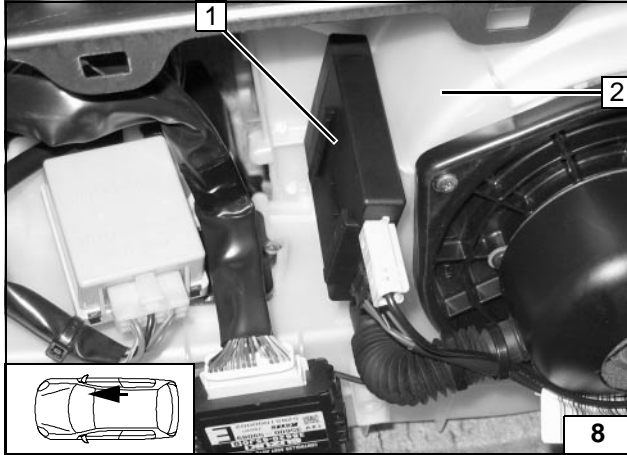

## Option Telestart

- 2 Fan housing
- 1 Receiver, Velcro tape (self-adhesive)

To install receiver

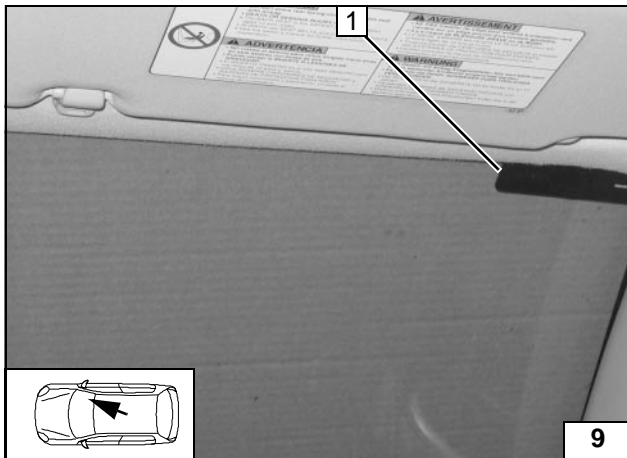

- 1 Aerial

To install aerial

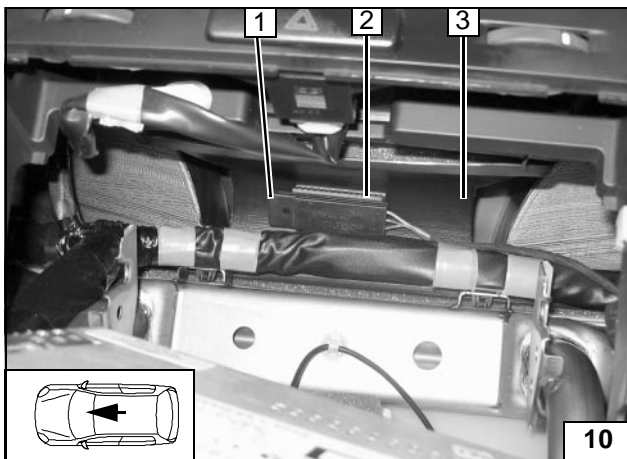

## Temperature sensor (only HTM 100)

- 1 Temperature sensor
- 2 Velcro tape (self-adhesive)
- 3 Air shaft

Temperature sensor HTM 100

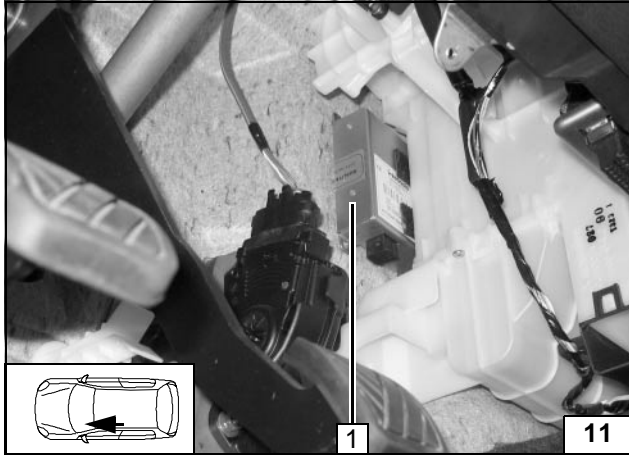

## Option Thermo Call

1 Receiver, Velcro tape (self-adhesive 2x)



To install receiver

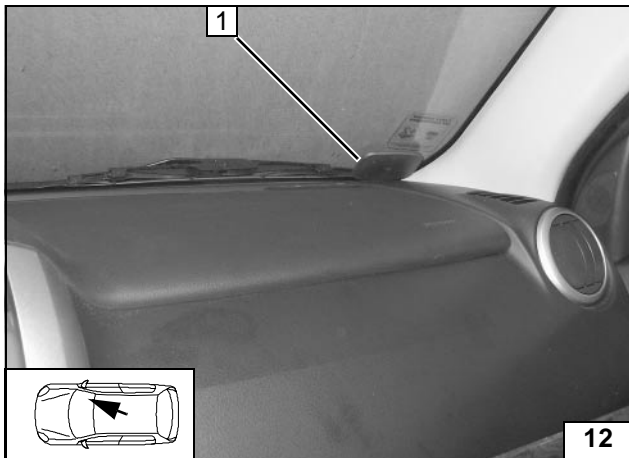

1 Aerial

To install aerial

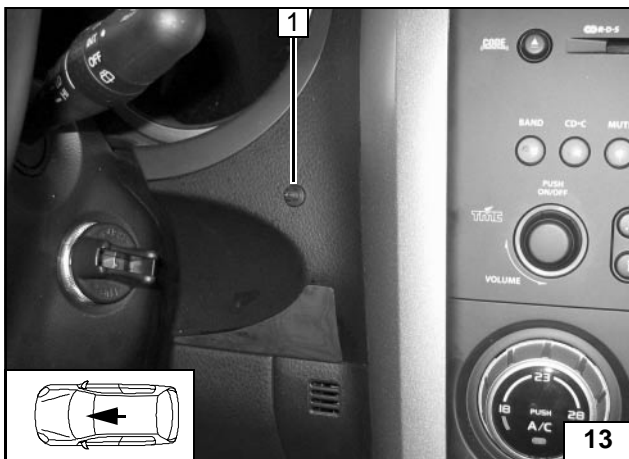

1 Button

To install button

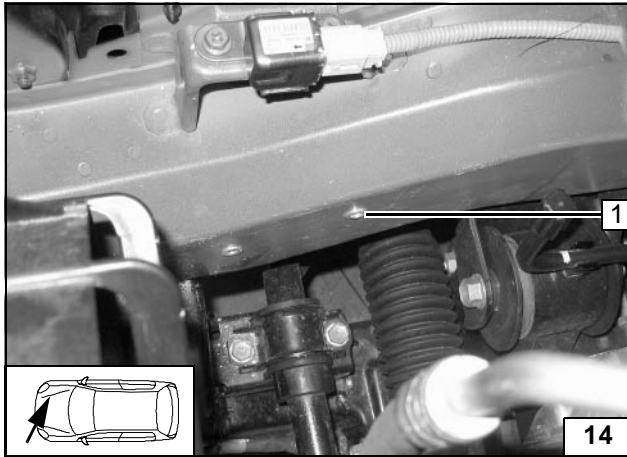
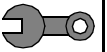

## Prepare installation site

- 1 Existing hole, rivet nut M6

To pull in rivet nut

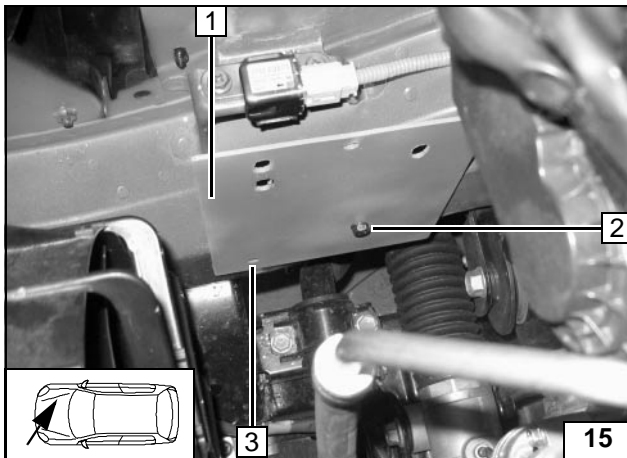

Install holder, align, transfer hole pattern!

- 1 Holder
- 2 Screw M6x20, spring ring
- 3 Hole pattern, hole diameter 9.1 mm



To transfer hole pattern

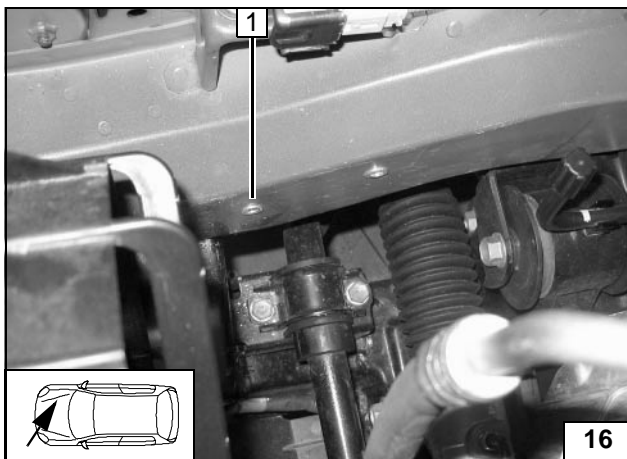

- 1 Rivet nut M6

To pull in rivet nut

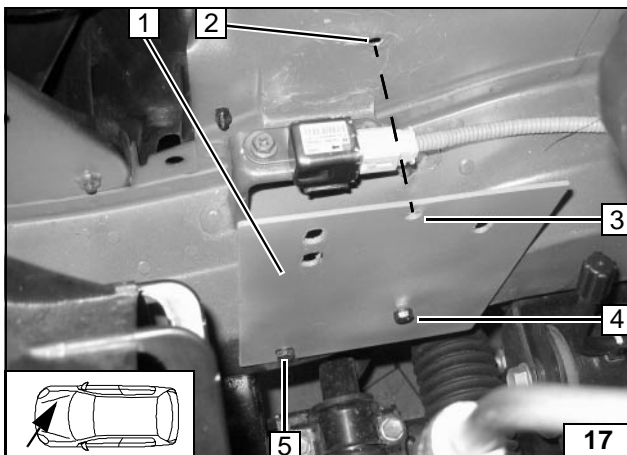

Install holder, transfer hole pattern, check distance to sensor!

- 1 Holder
- 2 Drill the hole with a diameter of 7 mm
- 3 Hole pattern holder
- 4 Screw M6x20, spring ring
- 5 Screw M6x20, spring ring



To install holder, transfer hole pattern

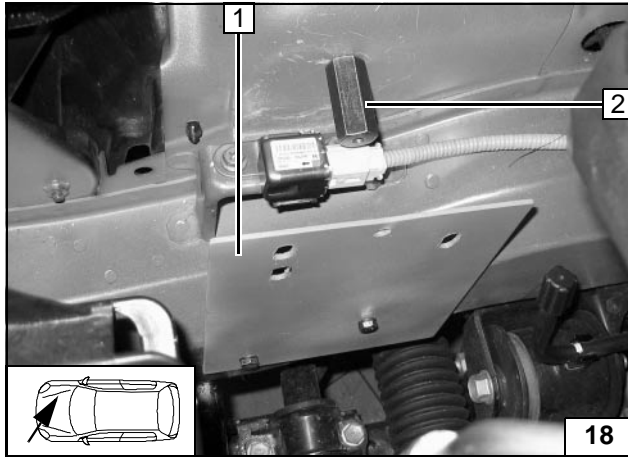
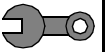

- 1 Holder
- 2 Screw M6x20, body washer, spring ring, spacer nut M6x40

To install holder

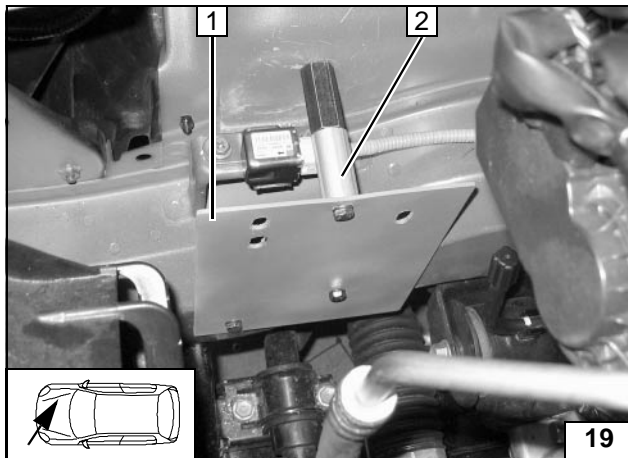

- 1 Holder
- 2 Screw M6x60, spring ring, spacer 40 mm

To install holder

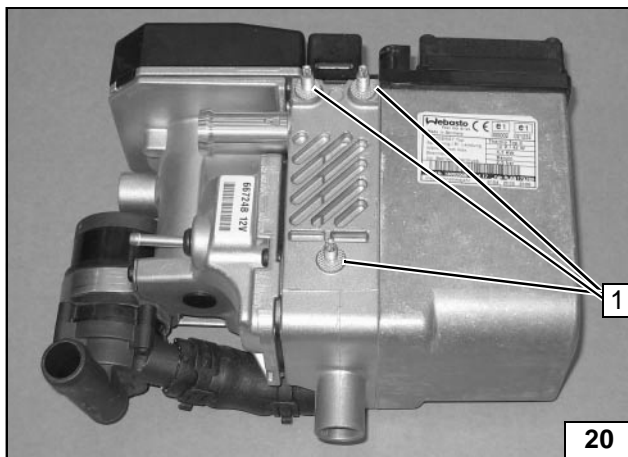

### Prepare heater

Ejot screws, tightening torque 10 Nm!

- 1 Ejot stud bolts



To prepare heater

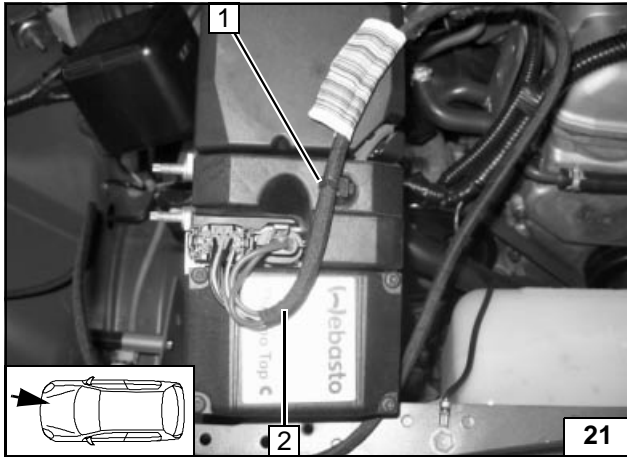
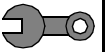

## Install heater

Connect the plug to the heater, spray protective wax onto the plug!

- 1 Clip cable tie in preperforated hole
- 2 Wiring harness heater



Installation of heater

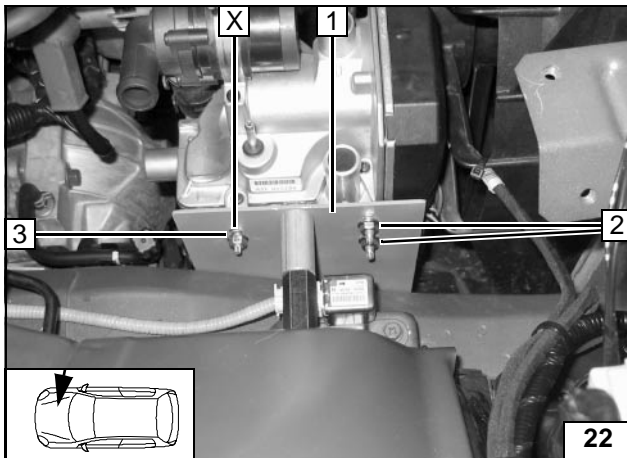

Align heater!

Ejot screws, tightening torque 10 Nm!  
Insert two washers at position x between the heater and holder!

- 1 Holder
- 2 Ejot stud bolts, collar nut M6 [2x]
- 3 Ejot stud bolts, collar nut M6



Installation of heater

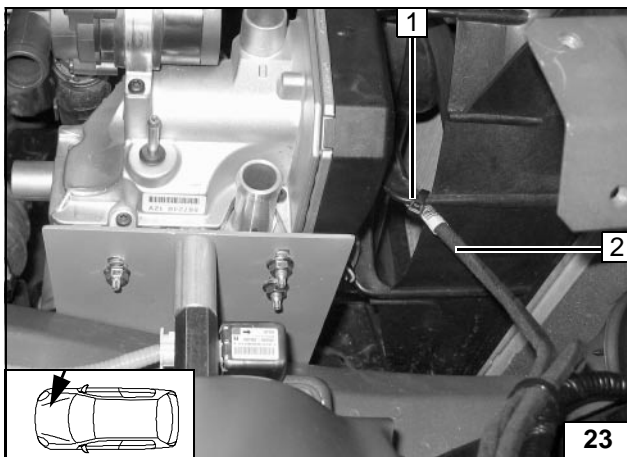

- 1 Cable tie
- 2 Wiring harness heater

Installation of heater

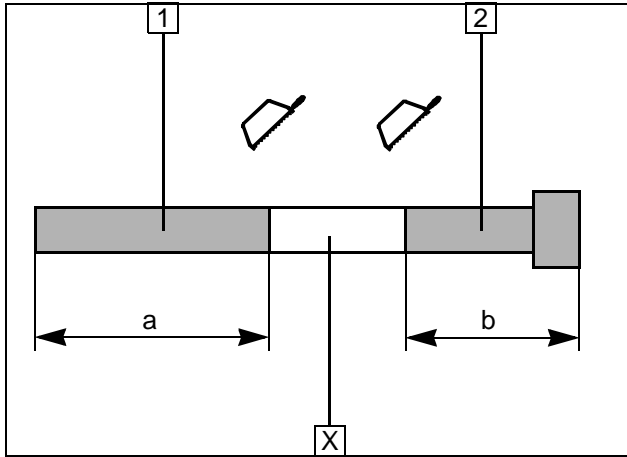
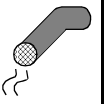

## Exhaust system

- 1 Exhaust line  
a = 520 mm
- 2 Exhaust end section  
b = 120 mm

Dispose of section X

To prepare exhaust line

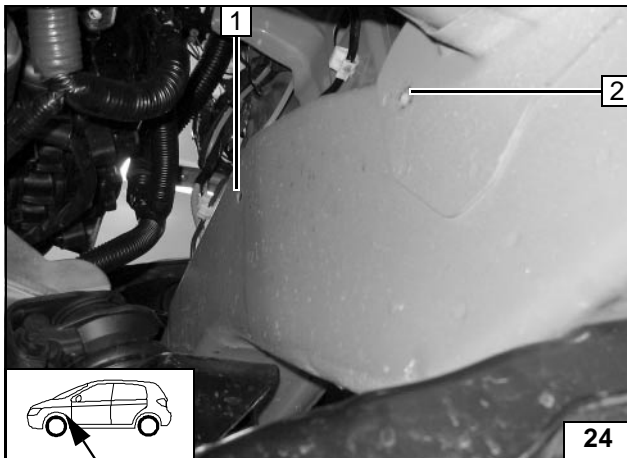

- 1 Existing hole, pull in rivet nut M6
- 2 Existing threaded insert M6

To prepare installation site

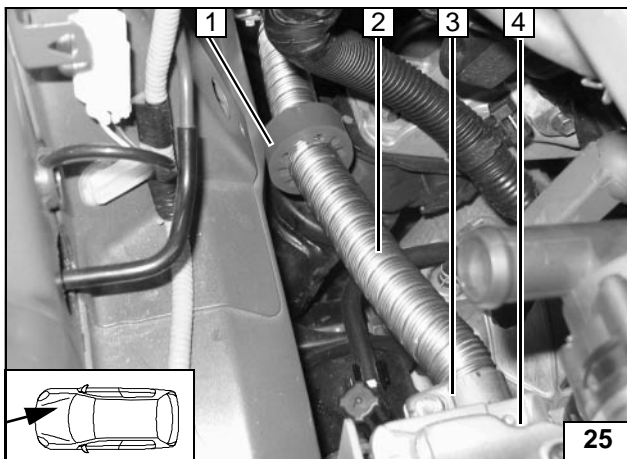

Ensure adequate distance!

- 4 Heater
- 2 Exhaust line
- 1 Red rubber section
- 3 Hose clip



To install exhaust line align rubber section

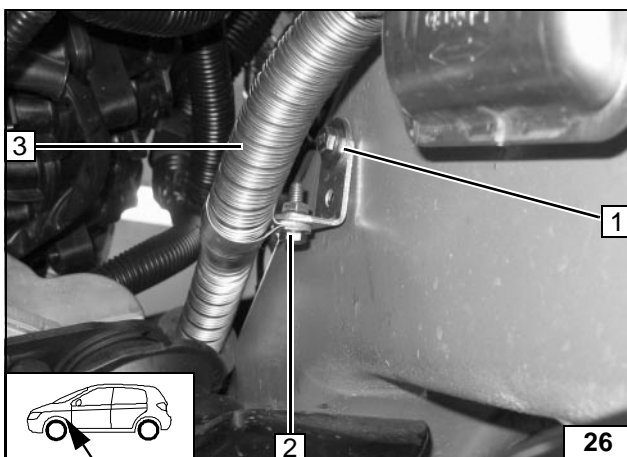

Ensure adequate distance!

- 1 Threaded insert M6, bracket, body washer, spring ring, screw M6x20
- 3 Exhaust line
- 2 Pipe clip, screw M6x20, collar nut M6



To install exhaust line and end section

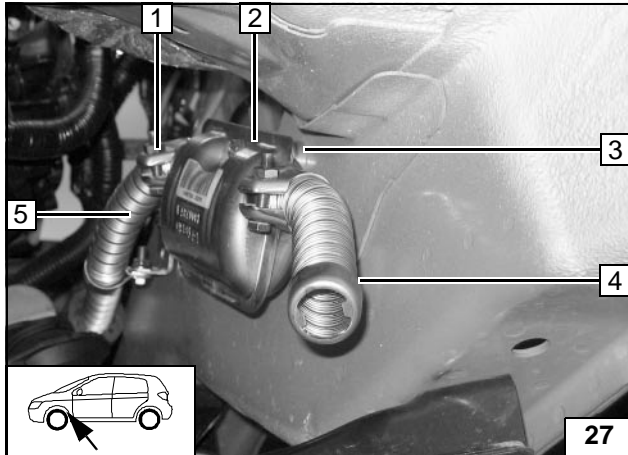

- 5 Exhaust line
- 1 Hose clip
- 3 Rivet nut M6
- 2 Exhaust silencer, spacer 30 mm, screw M6x50, spring ring
- 4 Exhaust line end section, hose clip

To install silencer

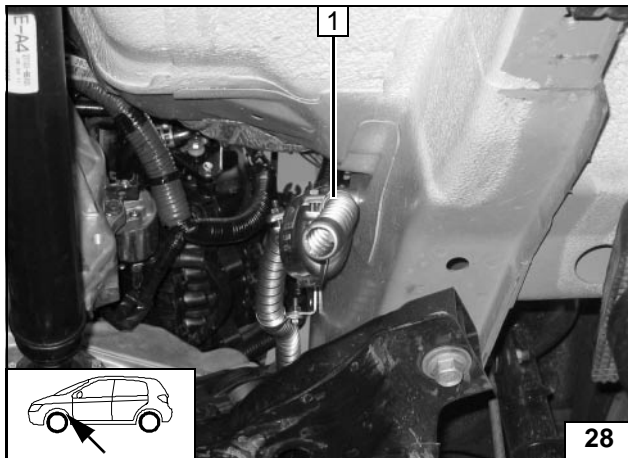

Ensure adequate distance!

- 1 Exhaust line end section



To align exhaust line end section



## Integration in fuel system

### WARNING!

Open the car's filler cap, vent the tank and close the filler cap again!

Catch escaping fuel using a suitable container!

Lay the fuel line and metering pump wiring harness so that they are protected from stones!

Unless indicated otherwise in the description, secure using cable ties!

Fit a chafe guard on the fuel line and wiring harness around sharp edges!

### IMPORTANT!

The fuel line and wiring harness for the metering pump are installed according to the wiring harness routing diagram.

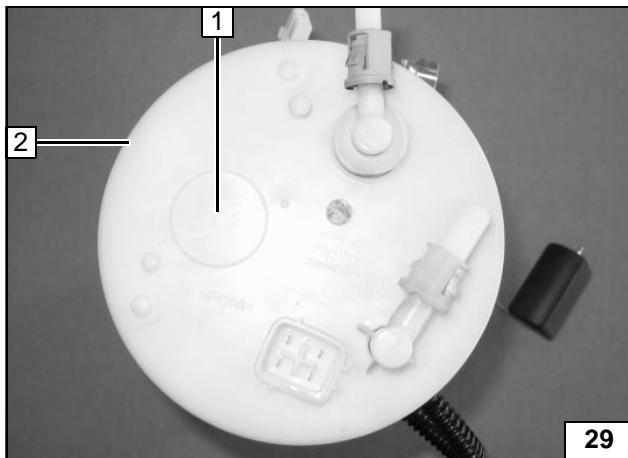

Remove and dismantle the tank fitting as instructed by the manufacturer!

Drill the hole with a diameter of 6 mm in the centre according to the figure.

- 2 Tank fitting
- 1 Existing embossing

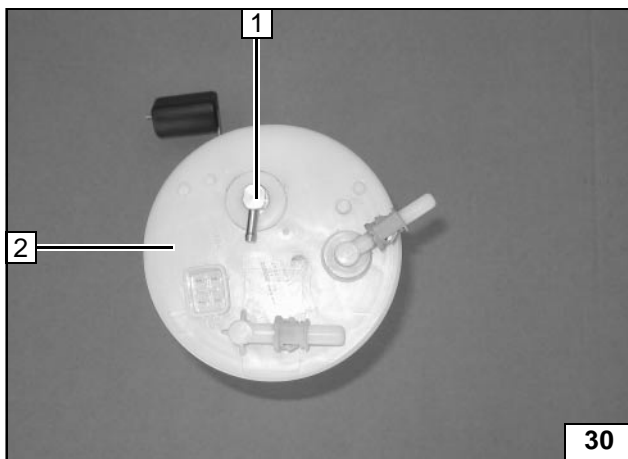

Shape and cut the tank connector to length in accordance with the template and insert it, see "installation instructions"!

- 1 Tank connector
- 2 Tank fitting

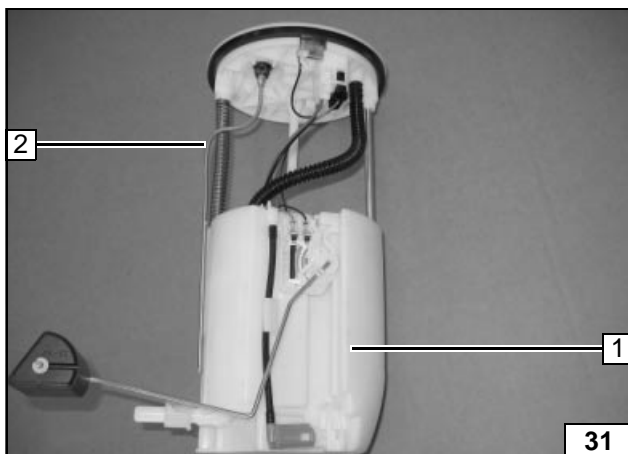

- 1 Tank fitting
- 2 Tank connector



To prepare tank fitting



To insert tank connector



To insert tank connector



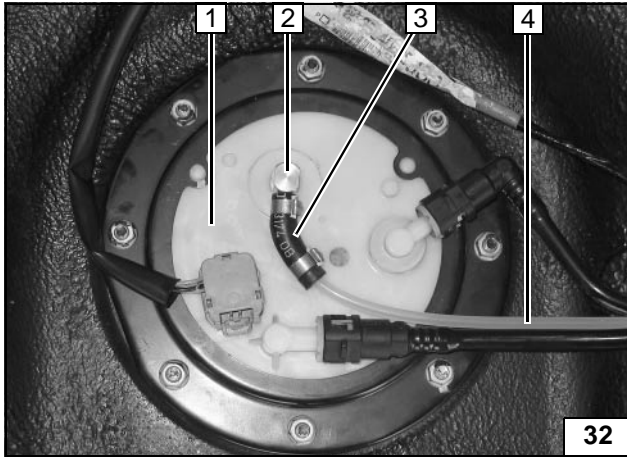

Install the tank fittings as instructed by the manufacturer!

- 1 Tank fitting
- 2 Tank connector
- 3 Hose section, hose clips diameter 10 mm [2x]
- 4 Fuel line



To connect fuel line

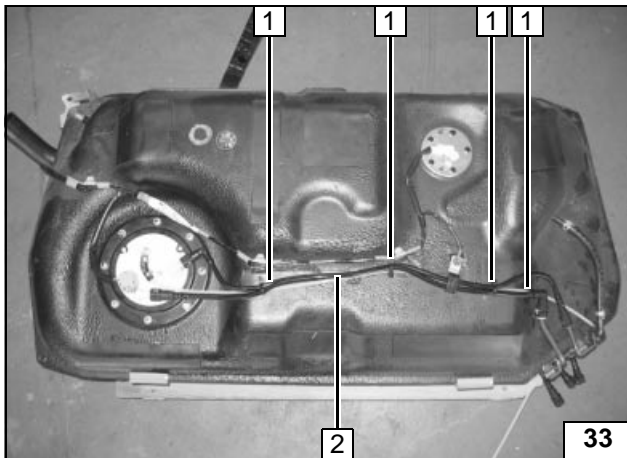

Install the fuel line without chafing!

- 2 Fuel line
- 1 Cable ties [4x]



Line routing

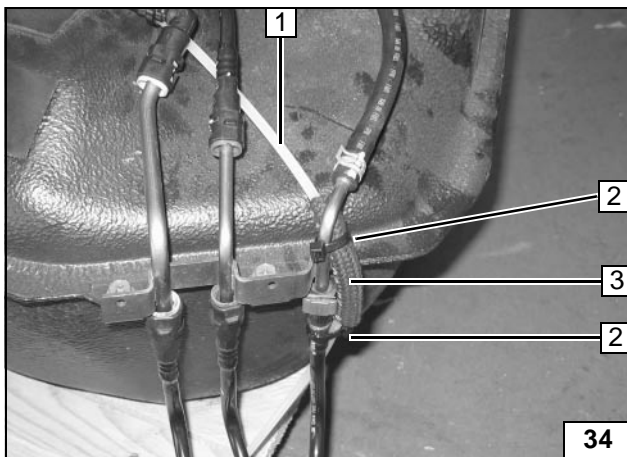

Install the fuel line without chafing!

- 1 Fuel line
- 3 Hose section (chafe guard)
- 2 Cable ties [2x]



Line routing

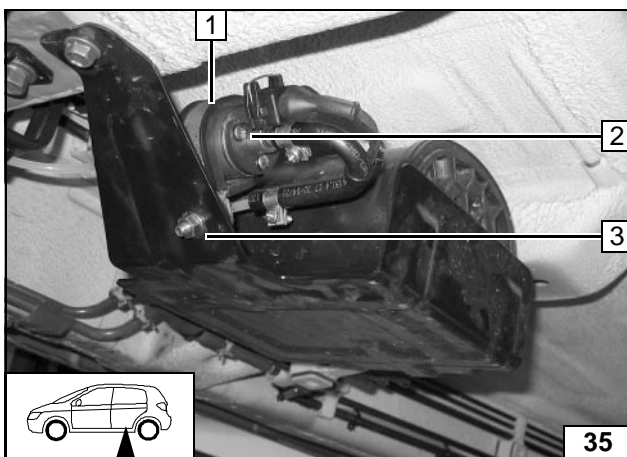

Install the tank as instructed by the manufacturer

Check the installation position of the metering pump, see "installation instructions"!

- 3 Drill the hole with a diameter of 6.5 mm
- 2 Metering pump
- 1 Rubberised clip, anti-vibration mount, collar nut M6 [2x]



Installation of metering pump



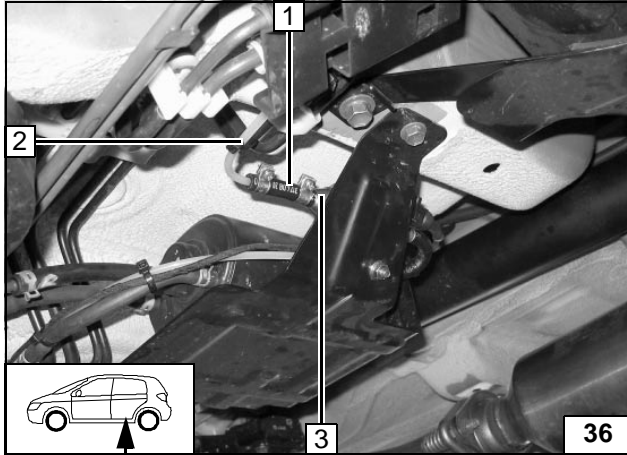

Fuel line from the tank connector to the intake side of the metering pump (side without plug). Check the position of the components and correct if necessary. Ensure that all moving parts can move easily.

Install the fuel line without taking up too much space!

- 2 Fuel line cut to length, cable tie
- 3 Metering pump
- 1 Hose section, hose clip 10 mm [2x]



**Connection to metering pump**

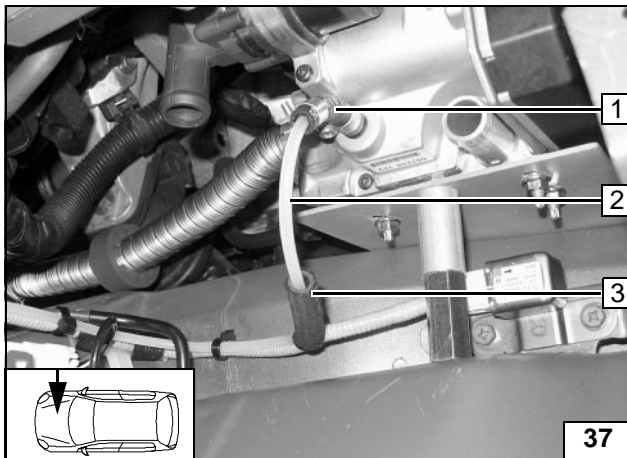

Install the fuel line without taking up too much space!

- 1 Hose section, hose clip 10 mm [2x]
- 2 Fuel line
- 3 Hose section (chafe guard)



**Connection at heater**

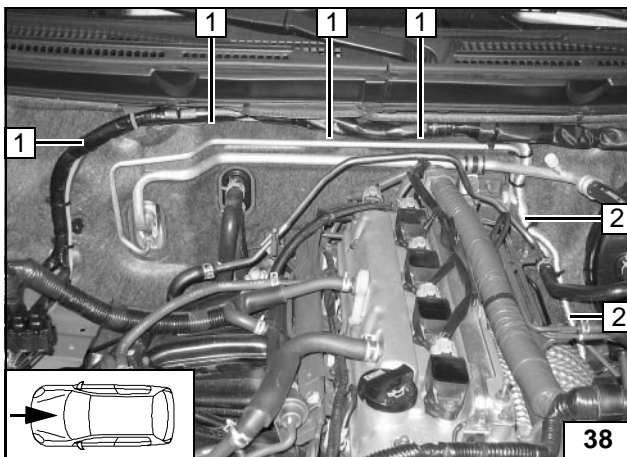

Position the fuel line and metering pump wiring harness and secure with cable ties!

Install the fuel line without taking up too much space!

- 1 Fuel line, metering pump wiring harness
- 2 Fuel line, metering pump wiring harness in heat protection hose



**Positioning of fuel line in engine compartment**

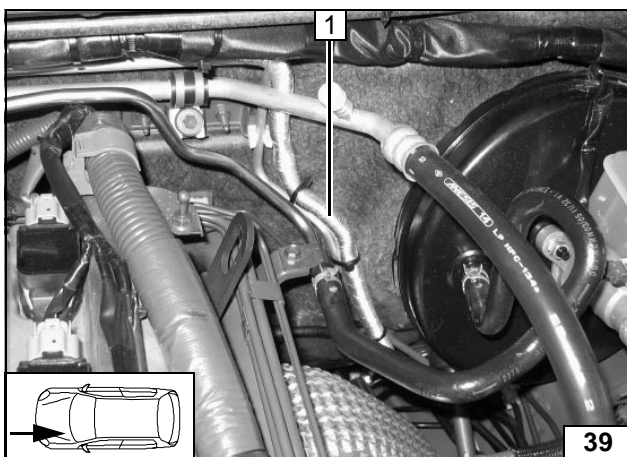

Route the heat protection line along the standard lines to the underbody, checking the distance to the exhaust system! Secure with cable ties!

- 1 Fuel line, metering pump wiring harness in heat protection hose



**Positioning of fuel line in engine compartment**

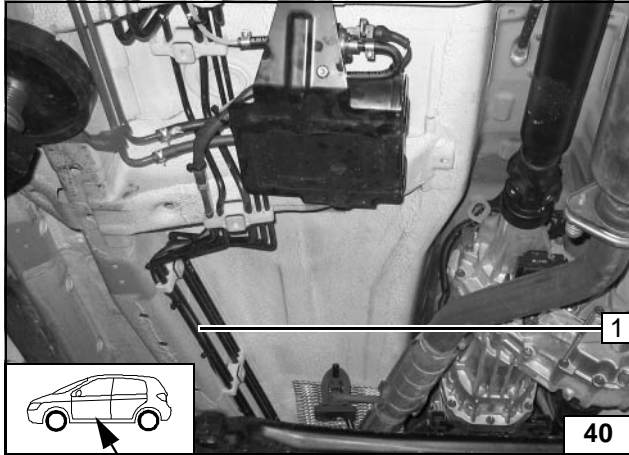

Install the fuel line and metering pump wiring harness without taking up too much space, secure to standard lines with cable ties!

- 1 Fuel line, metering pump wiring harness



Line routing

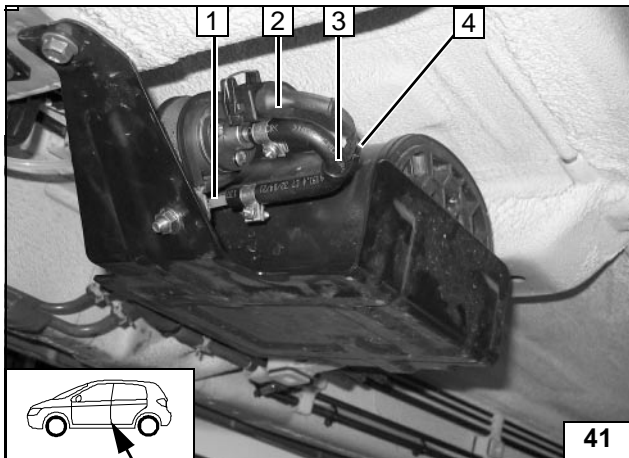

Fuel line from the heater to the discharge side of the metering pump (side with plug).

- 1 Fuel line
- 2 Wiring harness metering pump, plug metering pump
- 3 Shaped hose, hose clip 10 mm [2x]
- 4 Cable tie



Connection to metering pump

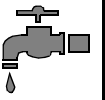

## Water connections

### IMPORTANT!

Tighten all hose clips with a torque of  $2.0 + 0.5$  Nm!

Catch escaping coolant water using a suitable container!

Install the water hoses with no kinks! Unless indicated otherwise in the description, secure using cable ties. Position hose clamps and spring strip clip so that no other hose can be damaged!

Carry out "inline" integration according to the following diagram:

### All vehicles

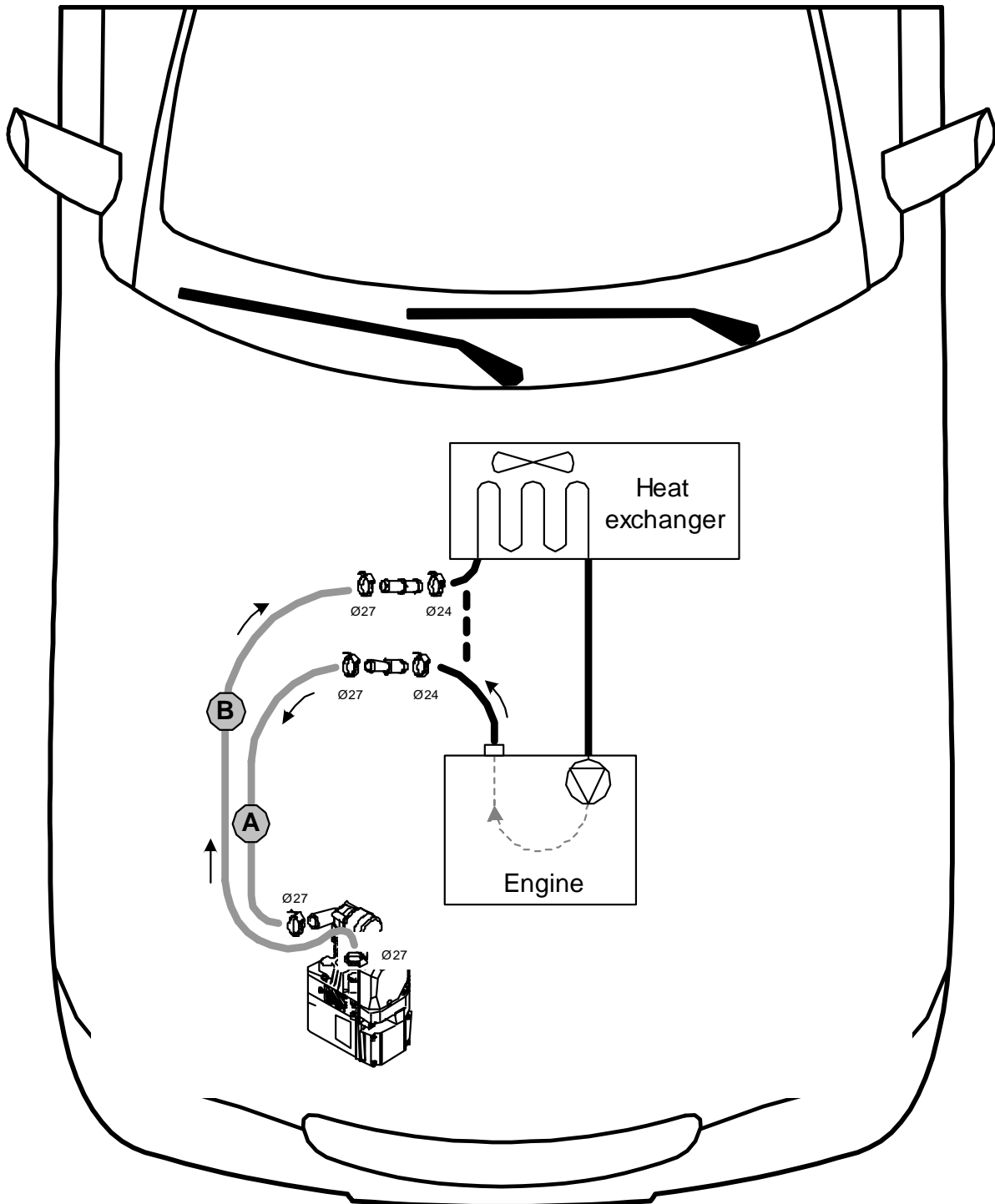

Water routing diagram

Connection pipes with 1.6 l petrol  $\varnothing 15 \times 20$ !  
 Connection pipes with 2.0 l petrol  $\varnothing 17 \times 20$ !



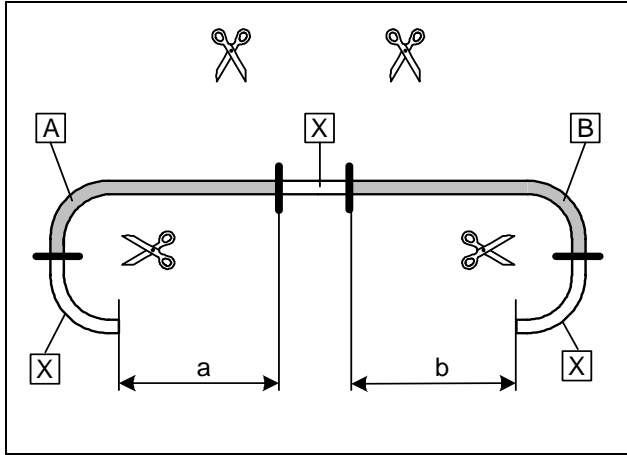
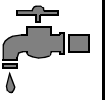

a = 570 mm  
b = 640 mm

Dispose of section X

To cut water hoses to length

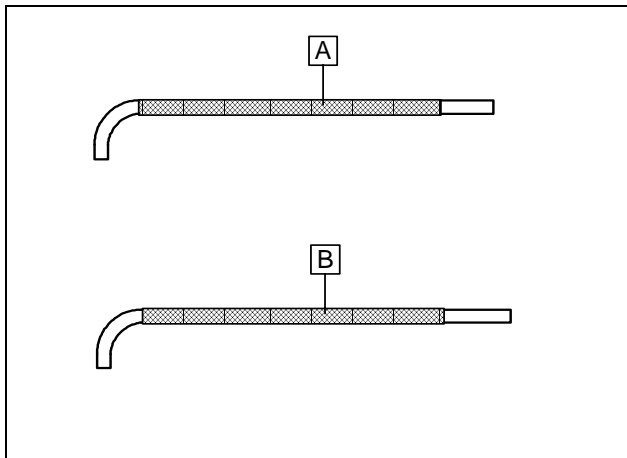

Cut woven protection hoses in half and push onto hose A and B



To prepare water hoses

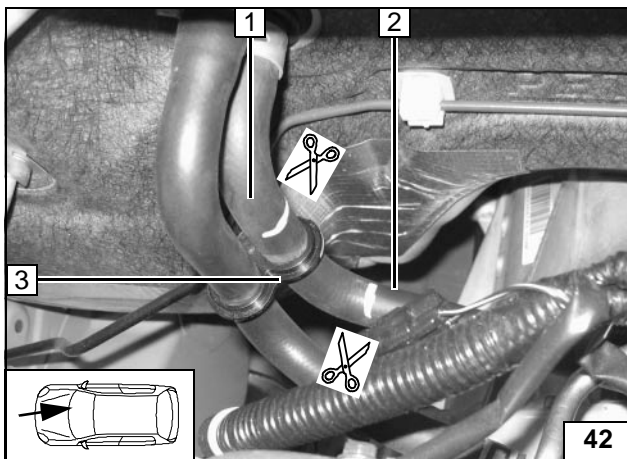

### Only for 1.6 petrol

- 1 Hose section heat exchanger input
- 2 Hose section engine output
- 3 Remove hose holder

Cut

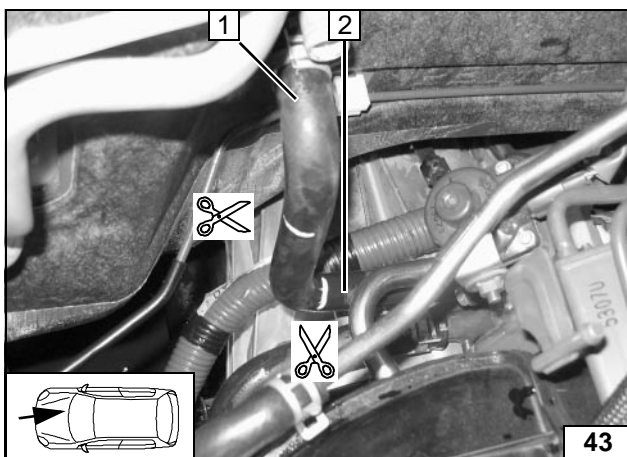

### Only for 2.0 petrol

Heat exchanger output hose not shown in the figure!

- 1 Hose section heat exchanger input
- 2 Hose section engine output

Cut

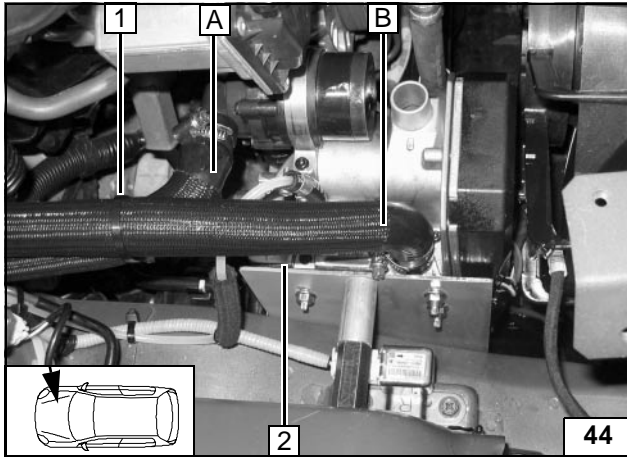

## All vehicles

- 1 Cable tie

Connection at heater

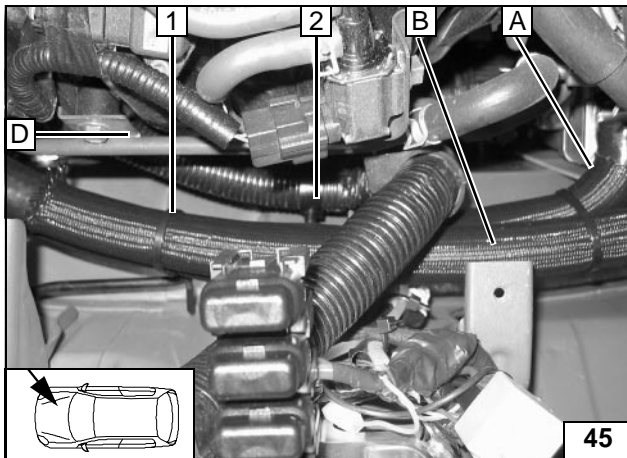

- 1 Cable tie
- 2 Hose holder

Positioning in engine compartment

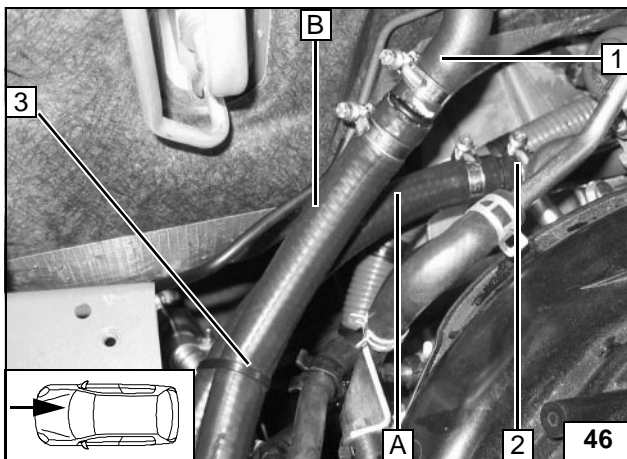

Fill the water hoses with cooling water before connecting!

- 1 Hose section heat exchanger input rotated
- 2 Hose engine output
- 3 Cable tie



Connection at engine output

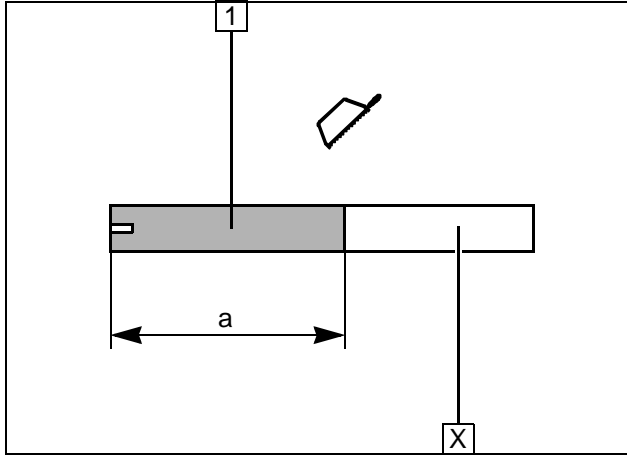
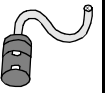

## Combustion air

- 1 Combustion air line  
a = 300 mm

Dispose of section X

To cut combustion air line to length

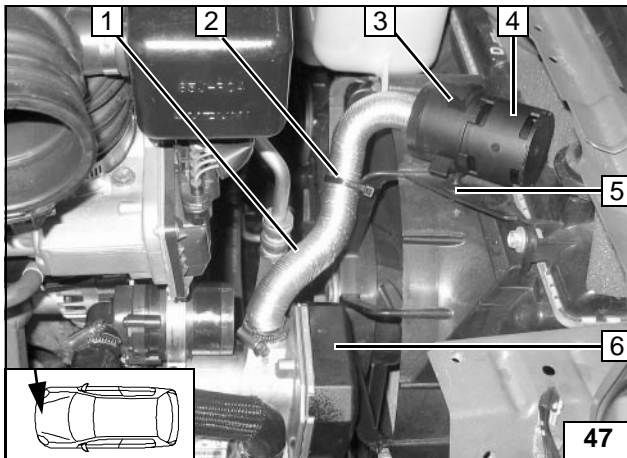

- 6 Heater
- 1 Combustion air intake line, hose clip diameter 27 mm
- 5 Hole diameter 6.2 mm
- 3 Retaining clip
- 4 Intake silencer
- 2 Cable tie



To install intake line and silencer

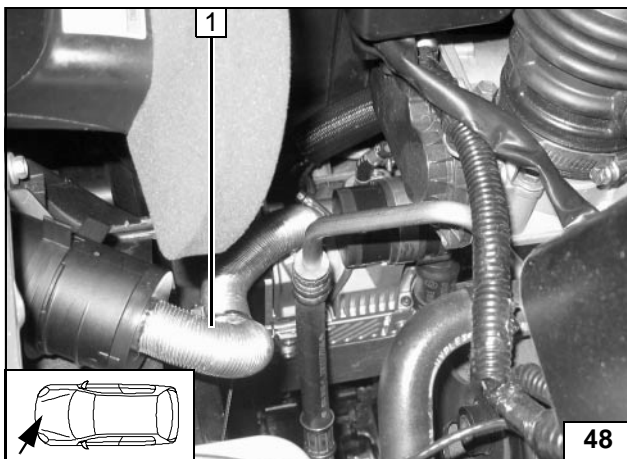

Install air filter housing and air system, checking for free movement of combustion air intake line!

- 1 Combustion air intake line



To align intake line

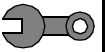

## Completion

### IMPORTANT!

Install all the removed parts in reverse order.

Check that all hose lines, hose, spring strip and Cailau clips and all electrical connections are secure. Secure all loose lines and cables with cable ties.

Spray the heater components with anti-corrosive wax (Tectyl 100K, order No. 111329).

- Connect the battery
- Start the engine, bleed the water system as described in the vehicle manufacturer's instructions, top up the coolant
- Set the digital time
- Set the vehicle heating as described in the "Operating instructions for the end customer", according to whether the vehicle has or does not have automatic air conditioning
- Check the function of the auxiliary heating system, see owner's manual / installation instructions
- Affix adhesive label "Standheizung vor dem Tanken abschalten" (Switch off auxiliary heating system before refuelling) to the B-pillar on the left



# Webasto

*Feel the drive*

Webasto AG  
Postfach 80 - 82132 Stockdorf - Hotline 0 18 05 / 93 22 78  
Hotfax (0395) 55 92-353 - <http://www.webasto.de>



## Operating instructions for the end customer

Please remove this page and insert it into the owner's manual for the vehicle!



Make the following settings before you shut down the car:

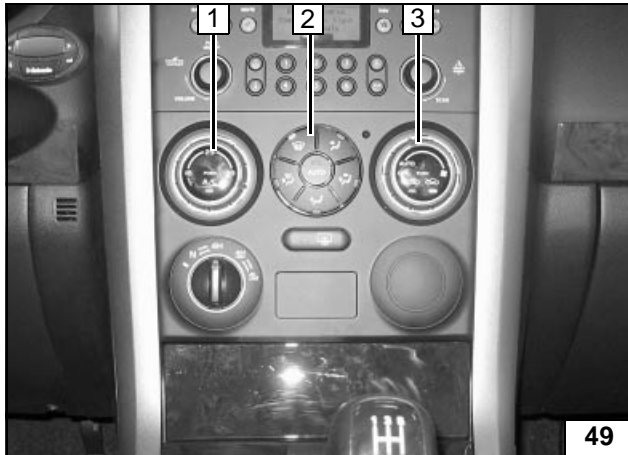

- 1 Temperature set to "28 max."
- 2 Air vent to windscreen
- 3 Blower to max. 1/3

For cars  
with  
automatic  
air-con-  
ditioning  
system

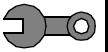

Tank connector template

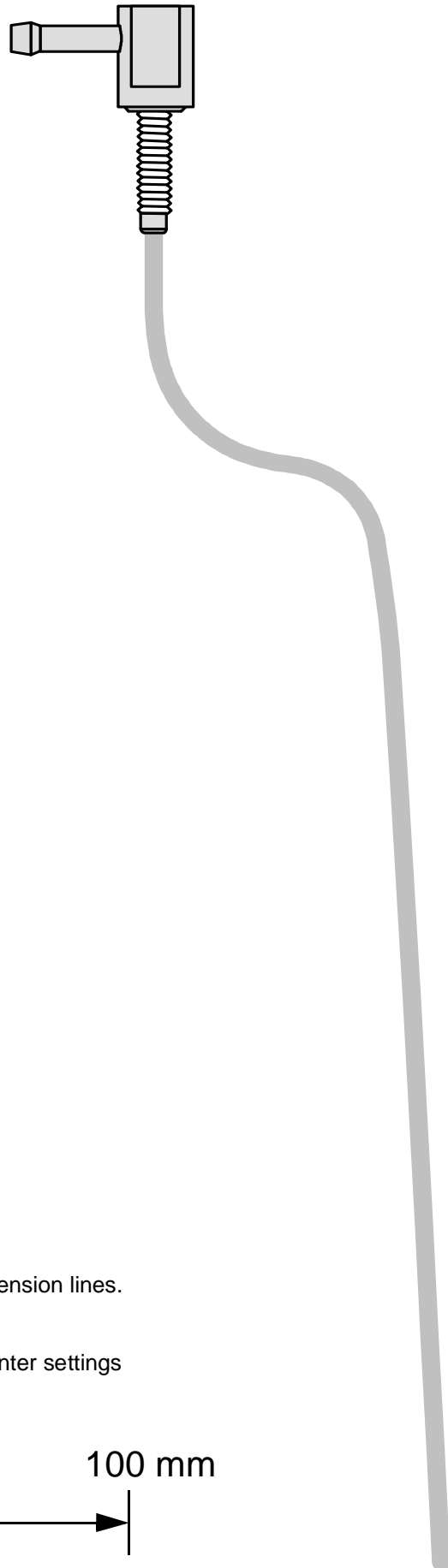

Scale 1:1

Compare the size of the hard copy with the dimension lines.  
Maximum tolerance 2%.

If the tolerance is larger than this correct the printer settings  
or request an original print.