

# Air Heater Unit



*Air Top 3500 ST D* Additional Heater



## Installation Instructions

### Renault Master/Nissan Interstar

Diesel  
from Model Year 2004  
Left-hand drive vehicle  
Vehicles without partition wall



#### **WARNING!**

#### **Hazard warning:**

**Incorrect installation or repair of Webasto heating systems may cause a fire or result in the emission of carbon monoxide, which can be fatal. Serious or fatal injuries can be caused as a result.**

**Specialist company training, technical documentation, specialized tools and equipment are required to install and repair Webasto heating and cooling systems.**

**NEVER attempt to install or repair Webasto heating or cooling systems if you have not successfully completed the company training and thereby acquired the required technical skills, or if you do not have access to the required technical documentation, tools and equipment needed to carry out correct installation and repairs.**

**ALWAYS follow all Webasto installation and repair instructions and observe all warnings.**

**Webasto does not accept any liability for defects and damage that are attributable to installation by untrained staff.**

# Renault Master/Nissan Interstar

## Table of Contents

Validity	2	Recirculating air intake	12
Heater Unit/Delivery Scope	3	Exhaust system	14
Foreword	3	Combustion air	15
General Instructions	3	Fuel Connection	16
Special Tools	3	Electrical Connections	19
Explanatory Notes on Document	4	Connection Diagram for Combination Timer and	
Preliminary Work	5	Telestart	20
Heater unit installation location	5	Heater control option	21
Preparing installation location	6	Remote option (Telestart)	22
Preparing heater unit	7	Installing trim parts	23
Installing heater unit	7	Final Work	24
Preparing hot air ducting	8	Template for Heater Unit	25
Preassembling hot air ducting	9		
Installing hot air ducting	9		
Installing hot air distribution	10		

## Validity

Manufacturer	Model	Type	EG-BE No./ABE
Nissan	Interstar	J3	e2 * 2001 / 116 * 273
		F3	L223
		U3	L414
		E3	N004
		N3	L226

Manufacturer	Model	Type	EG-BE No./ABE
Renault	Master	JD	e2 * 98 / 14 * 0129
		ED	H914
		FD	H912
		GD	K150
		HD	K149
		UD	H913
		ND	K309
		PD	K535
		RD	K535

Engine type	Engine model	Output in kW	Displacement in cm <sup>3</sup>
F9Q	Diesel	60	1870
G9T	Diesel	66	2188
G9T	Diesel	84	2188
G9U	Diesel	73	2463
G9U	Diesel	74	2463
G9U	Diesel	88	2463
G9U	Diesel	107	2463
ZD3	Diesel	100	2953

# Renault Master/Nissan Interstar

## Heater Unit/Delivery Scope

Quantity	Description	Order No.:
1	Delivery scope of AT 3500 ST D 12V with heater control	9008944A
1	Installation kit Renault Master / Nissan Interstar Diesel AT3500ST	1312622B

## Optional heater control either:

Quantity	Description	Order No.:
1	Digital timer (combination 12 V)	9010385A
1	Mounting plate for digital timer (frame)	474630
1	Telestart (only in conjunction with combination timer)	See price list
1	Y-cable for combination timer - Telestart	1311194A

## Foreword

These installation instructions apply to Renault Master/Nissan Interstar vehicles with a Diesel engine - for validity, see page 2 - from model year 2004 and later, assuming technical modifications to the vehicle do not affect installation, any liability claims excluded. Depending on the version and the equipment variants of the vehicle, changes may be necessary relative to these "installation instructions" during installation and must be adjusted accordingly.

However, where this is the case the stipulations in the "installation instructions" and "operating and maintenance instructions" for the *Air Top 3500 ST* should be observed.

The corresponding rules of technology and any information from the vehicle manufacturer should be observed during the installation work.

The installation location of heater controls and the routing of the air ducting parts must be coordinated with the final customer prior to installation!

## WARNING!

Original load-bearing components of the vehicle and/or component used for crash safety may not be modified for the hot air and recirculating air ducting!

## General Instructions

Installation should be carried out according to the general, standard rules of technology. Unless specified otherwise, fasten hoses, lines and wiring harnesses to original vehicle lines and wiring harnesses using cable ties.

Sharp edges should be fitted with edge protectors (split-open plastic hose).

Spray unfinished body areas, e.g. drilled holes, with anti-corrosion wax (Tectyl 100K, Order No. 111329).

## Special Tools

- Metric thread-setter kit
- Hole circle bit 83 mm dia.
- Hole circle bit 92 mm dia.

## Explanatory Notes on Document

To provide you with a quick overview of the individual working steps, you will find an identification mark on the outside top right corner of the page in question.

### Mechanical work



### Electrical system



### Hot air system

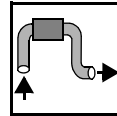

### Fuel connection



### Exhaust system

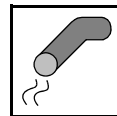

### Combustion air



Special features are highlighted using the following symbols:



Specific risk of injury or fatal accidents.



Specific risk of damage to components.



Specific risk of fire or explosion.



Reference to general installation instructions of Webasto components or to the manufacturer's vehicle-specific documents.



Reference to a special technical feature.

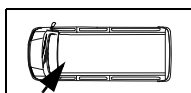
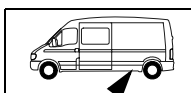

The arrow in the vehicle icon indicates the position on the vehicle and the viewing angle.

## Preliminary Work

### WARNING!

- Disconnect the battery "earth" or "ground" connection.
- Copy the factory number from the original type label to the duplicate type label.
- Remove years that do not apply from the duplicate label.
- Attach the duplicate label (type label) in the appropriate place.
- If installed, remove the rear seat row behind the driver's seat
- If installed, remove the floor covering behind the driver's seat
- Remove the trim of the A-pillar on the driver's side
- Remove the sun vizer on the driver's side
- Remove the front left side trim in the cargo space (only with cargo space trim)

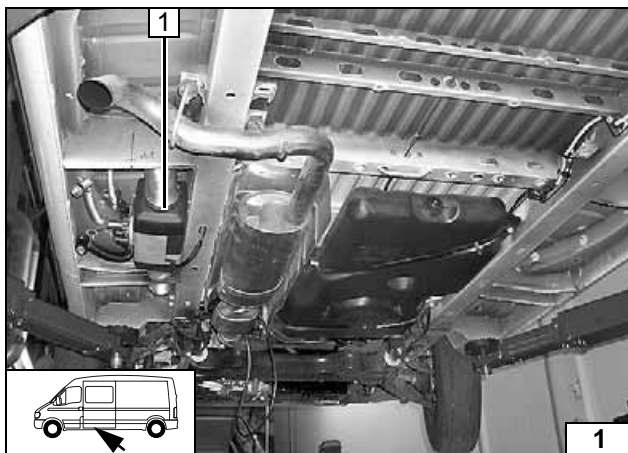

### Heater unit installation location

1 Heater unit

Installation  
location

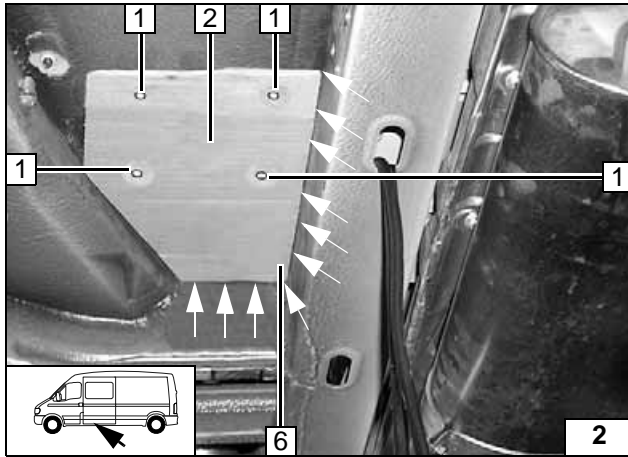
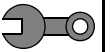

## Preparing installation location

Lay on drilling template 2 provided exactly; remove underbody protection in corners as shown (arrows) if necessary. Holes may not be located in area of beads.

- 1 Copy hole pattern, drill 7 mm hole [4x] in floor panel



Copying hole pattern

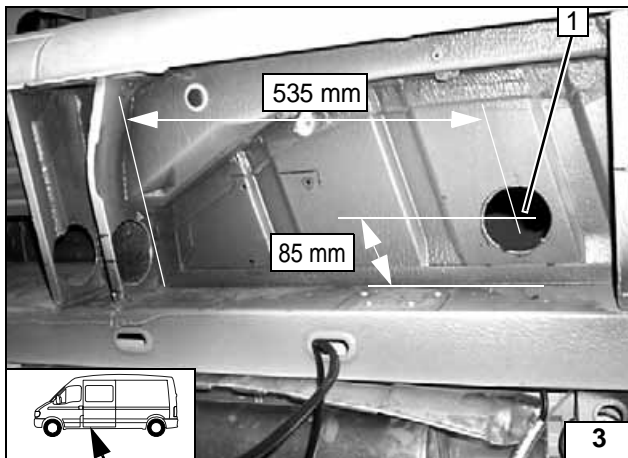

Reapply underbody protection.

- 1 83 mm dia.hole in floor panel



Hole in floor panel

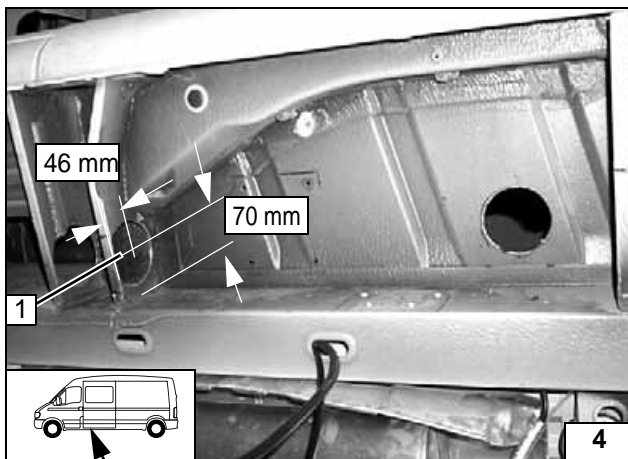

Drill opening so that only horizontal bar is left in place.

- 1 92 mm dia. hole in floor panel



Hole in floor panel

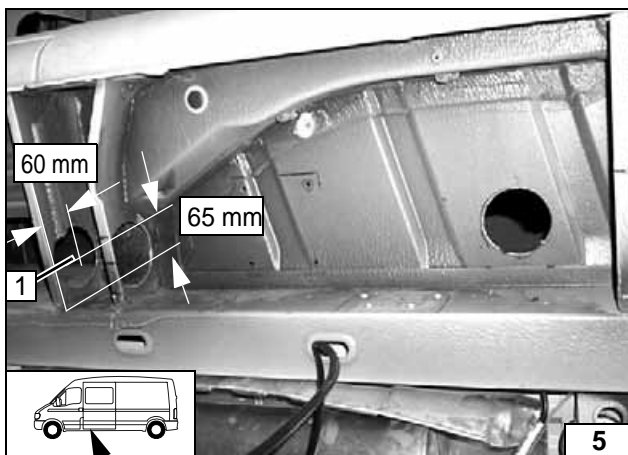

Ensure sufficient corrosion protection for all holes.

- 1 92 mm dia. hole in floor panel, install edge protection



Hole in floor panel

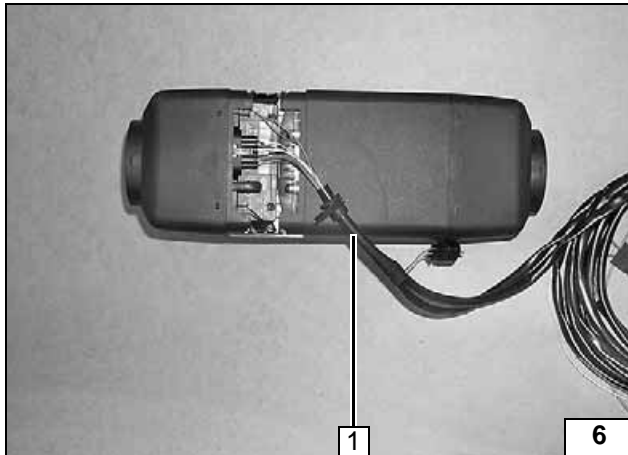
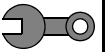

## Preparing heater unit

- 1 Push on wiring harness

Connect-  
ing wiring  
harness



- 1 Mount cover offset by 180°

Installing  
cover

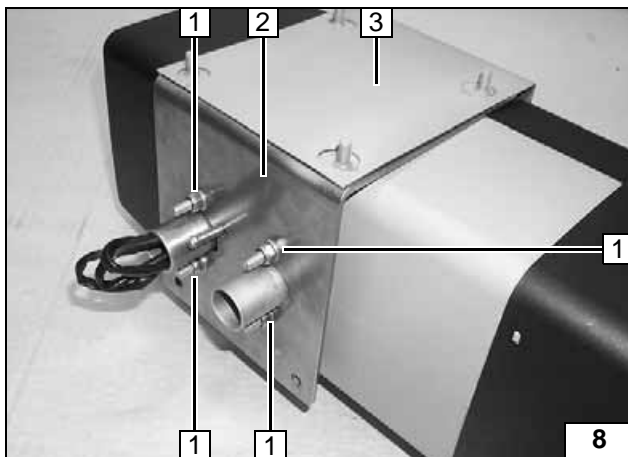

- 2 Bracket of heater unit
- 1 Washer, self-locking nut [4x each]
- 3 Loosely lay on bracket for splash protection

Installing  
bracket

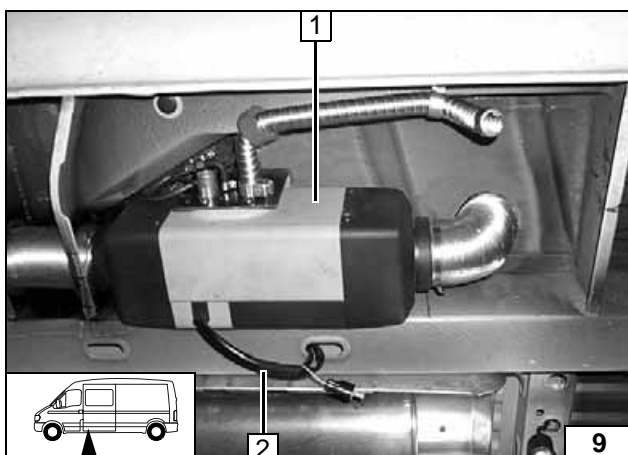

## Installing heater unit

Fasten preassembled heater unit **1** to underbody with 4 self-locking M6 nuts and 4 large diameter washer.  
Remove red (rt) wire in wiring harness to fuse holder on blade-type fuse holder.  
Route wiring harness of fuse and digital/combination timer **2** in frame side member along frame side member to battery box.  
Insert red (rt) wire again on fuse holder.  
Fasten wiring harness with cable ties.



Installing  
heater unit

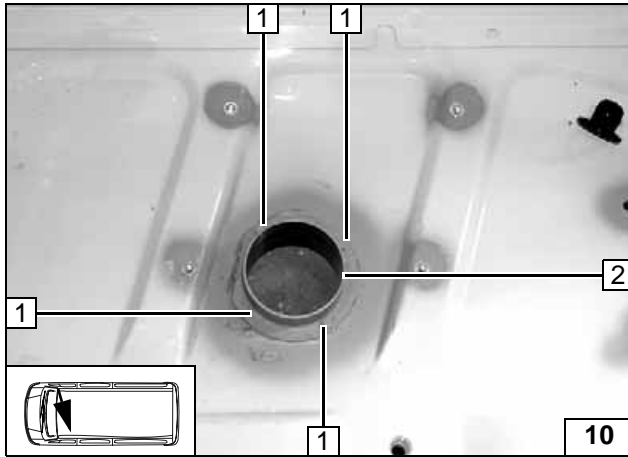
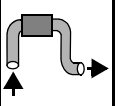

## Preparing hot air ducting

- 2 Insert pass through into existing opening
- 1 Copy hole pattern, drill 4.5 mm hole [4x]

Preparing pass through

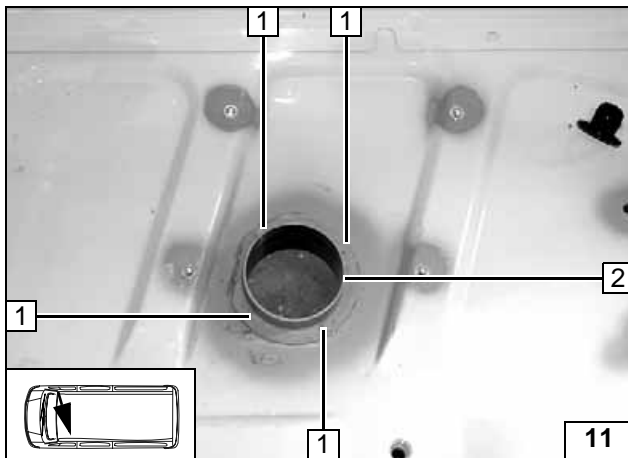

- 2 Insert pass through in existing opening and seal off with sealing compound
- 1 M4x12 bolt [4x], washers [8x], M4 flanged nut [4x]

Installing pass through

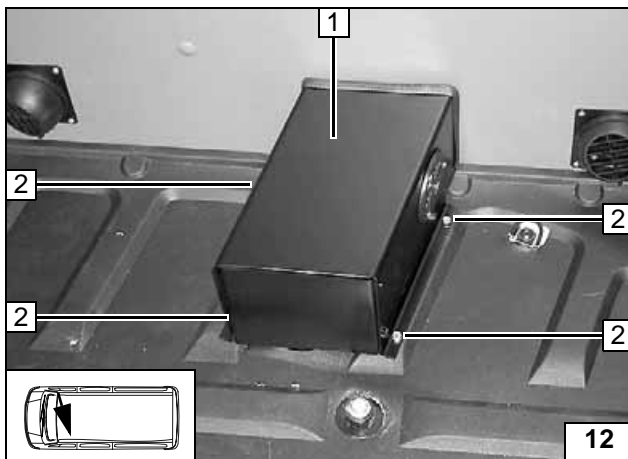

- 1 Position kick guard
- 2 Copy hole pattern for 9.1 mm hole [4x]

Lay on kick guard

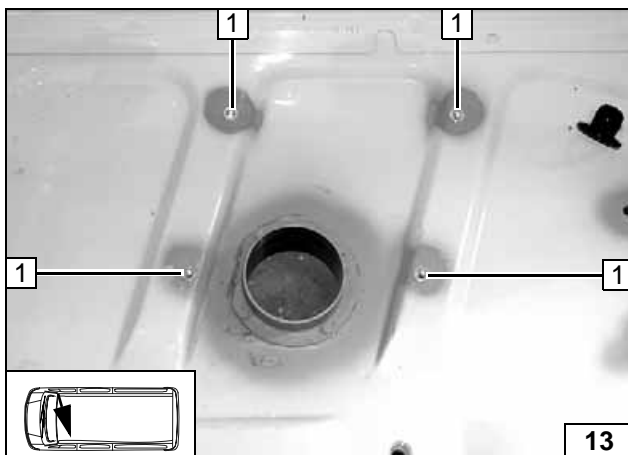

- 1 Drill out hole to 9.1 mm dia., mount rivet nut [4x each]

Installing rivet nut



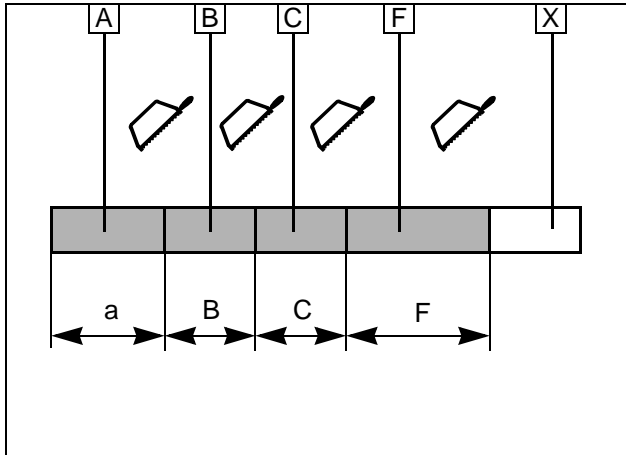
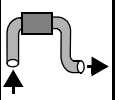

## Preassembling hot air ducting

- A** 80 mm dia. flexible tube  
a = 125 mm
- B** 80 mm dia. flexible tube  
a = 125 mm
- C** 80 mm dia. flexible tube  
b = 120 mm
- F** 80 mm dia. flexible tube (for recirculating air)  
f = 385 mm
- X** Discard section

**Cutting flexible tube to length**

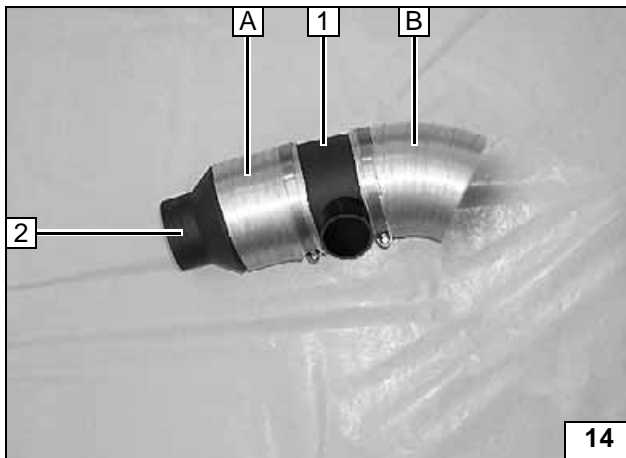

Fasten flexible tube with hose clamps as shown.

- 1** 80/60/60/80 branch
- A** 125 mm flexible tube cut to length
- 2** 80/55 reducer
- B** 125 mm flexible tube cut to length



**Installing pass through**

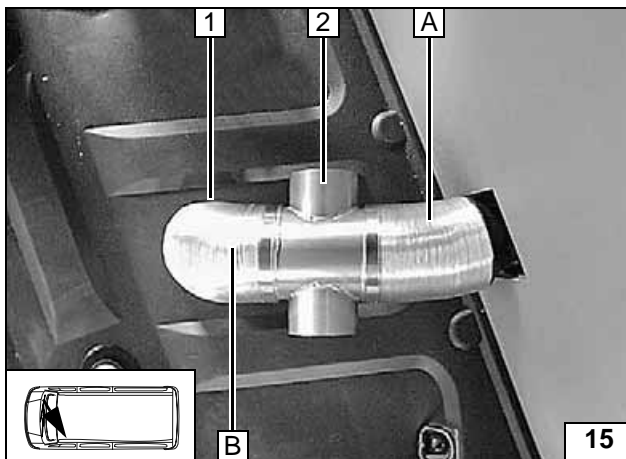

## Installing hot air ducting

Mount preassembled hot air ducting on pass through **1** and fasten with hose clamp. When doing so, align 80/60/60/80 branch **2** as shown.



**Installing hot air ducting**

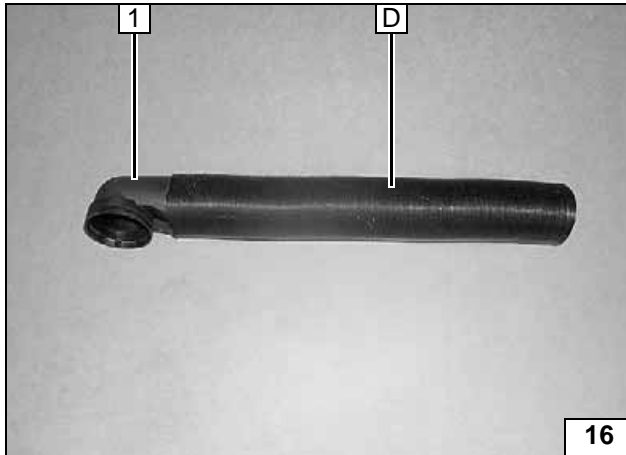
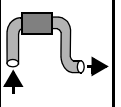

**D** 400 mm PAK pipe  
**1** 90° hot air elbow

**Preassembling distribution**

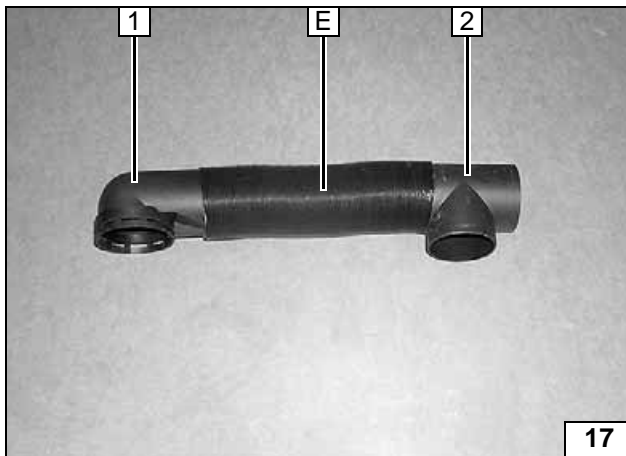

**E** 200 mm PAK pipe  
**1** 90° hot air elbow  
**2** 60/60/60 distributor

**Preassembling distribution**

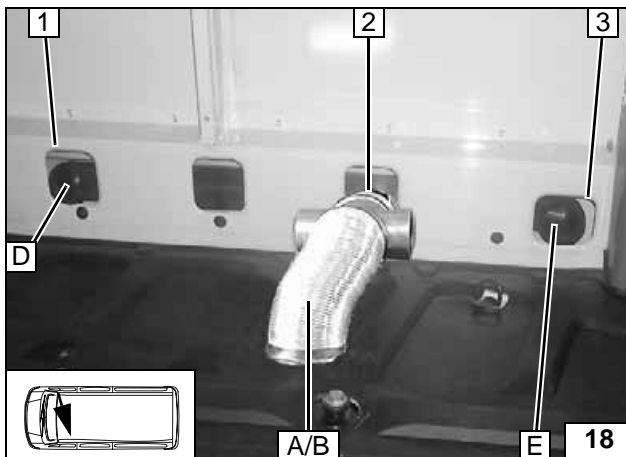

## Installing hot air distribution



Insert preassembled hot air distribution **D** into existing opening **3** with 90° hot air elbow first and route to left-hand opening **1**.  
 Insert preassembled hot air distribution **E** into existing opening **3** with 60/60/60 distributor first and push onto preassembled hot air distribution **D** as far as possible.

**On vehicles without side trim:**  
 Push preassembled hot air ducting **A/B** with 80/55 reducer onto distributor **2**.  
 Drill 2.5 mm hole through reducer and distributor. Connect reducer and distributor with self-tapping screw.

**Installing distribution**

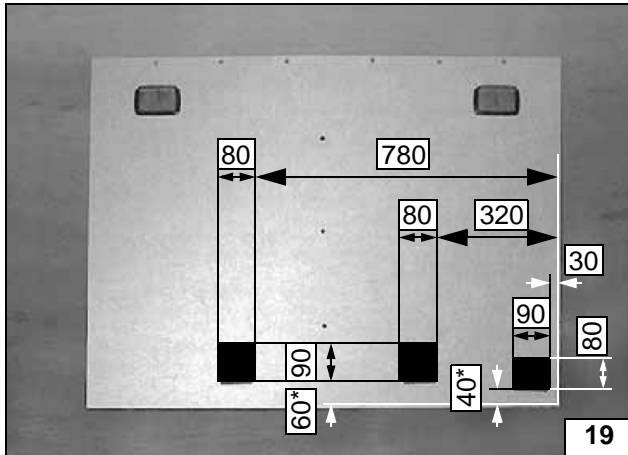
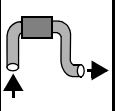

### On vehicles with side trim:

The dimensions 40 mm and 60 mm are specifications for a side panel that reaches down to the floor panel. Should a side panel be installed that does not reach down to the floor panel, these dimensions must be calculated in accordance with the distance to the floor panel.

Cut out side trim as shown

### Cutting out side trim

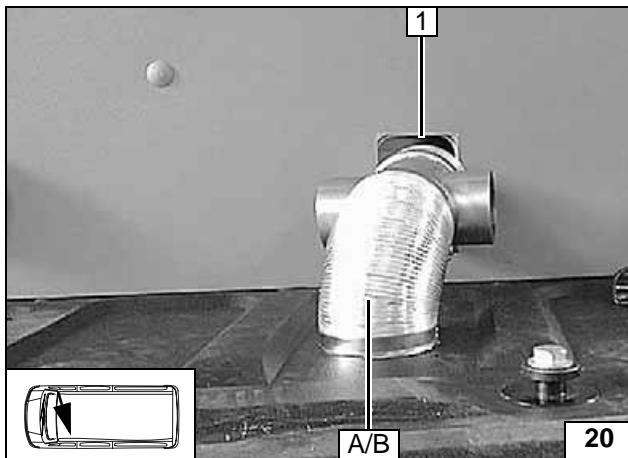

Mount side trim. Push preassembled hot air ducting **A/B** with 80/55 reducer onto distributor **1**.

Drill 2.5 mm hole through reducer and distributor. Connect reducer and distributor with self-tapping screw.

### Preassembling distribution

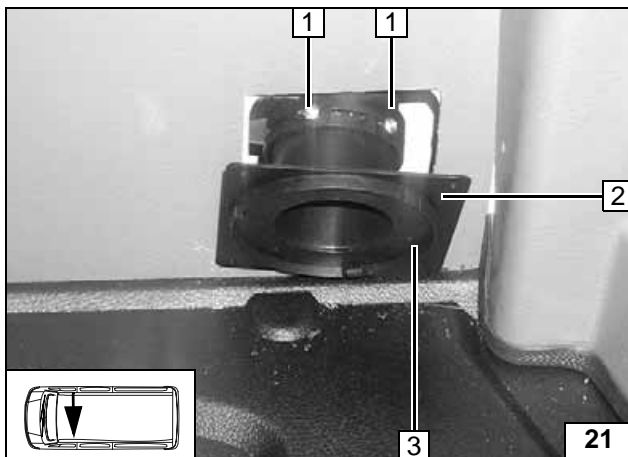

### All vehicles

Shorten connection piece from air outlet by approx. 10 mm on vehicles without side trim. Mount cover piece **2** on air outlet **3**. Mount air outlet **3** with cover piece **2** on each hot air elbow. Drill 2 2.5 mm dia. holes **1** each through reducer and distributor. Connect reducer and distributor with self-tapping screw.

### Installing air outlet

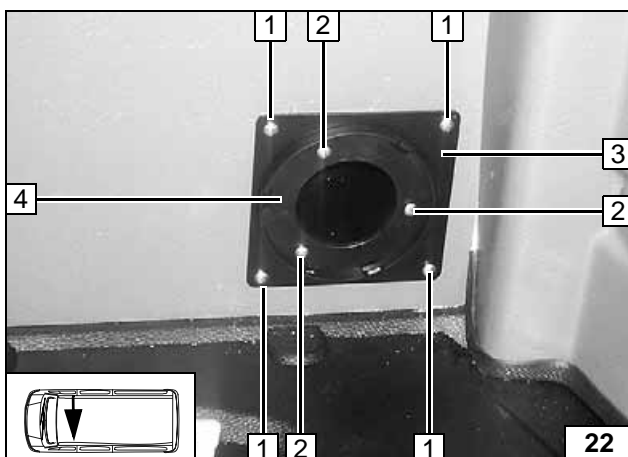

When drilling, watch components located behind!

Copy hole pattern **1** from cover piece **3** to side panel or trim in each case.

Copy hole pattern **2** from air outlet **4** to cover piece **3** in each case.

**1** 2.5 mm dia. hole, self-tapping screw [4x each]

**2** 2.5 mm dia. hole, self-tapping screw [3x each]

### Installing air outlet

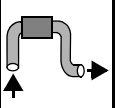

Mount rotating air outlet grid 1 [2x] on air outlet and engage.



## Installing grids

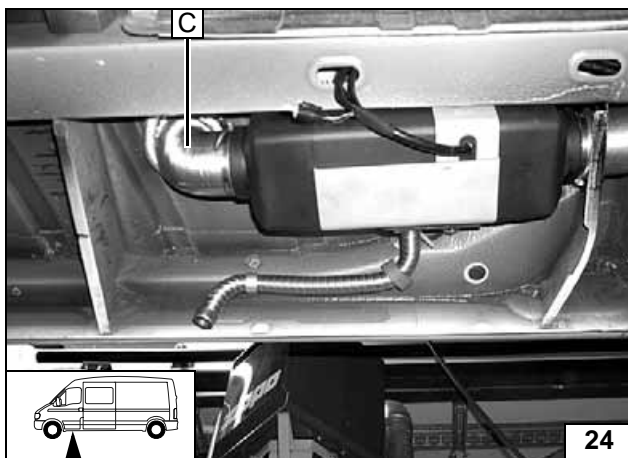

Shape 120 mm long flexible tube C as shown, mount on heater unit hot air outlet and on pass through and fasten with hose clamps.



## Installing flexible tube

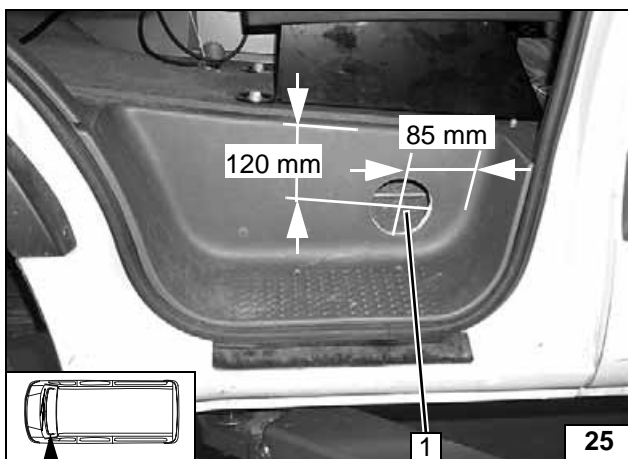

## Recirculating air intake

Remove entrance trim on driver's side. Flatten beads in metal sheet in area of pass through with flattening tool. Ensure sufficient corrosion protection for all holes.



## Hole in floor panel

1 83 mm dia. hole in entrance trim of driver's side and in metal sheet behind it

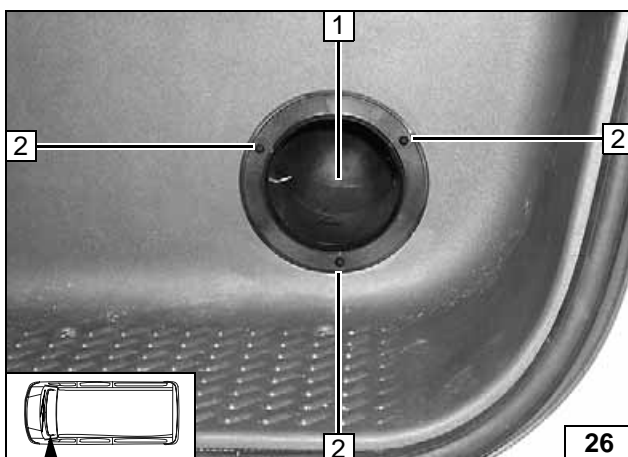

Seal off pass through from behind with sealing compound.

1 Insert pass through in 83 mm dia. hole  
2 2.5 mm dia. hole, self-tapping screw [3x each] in entrance trim



## Installing pass through

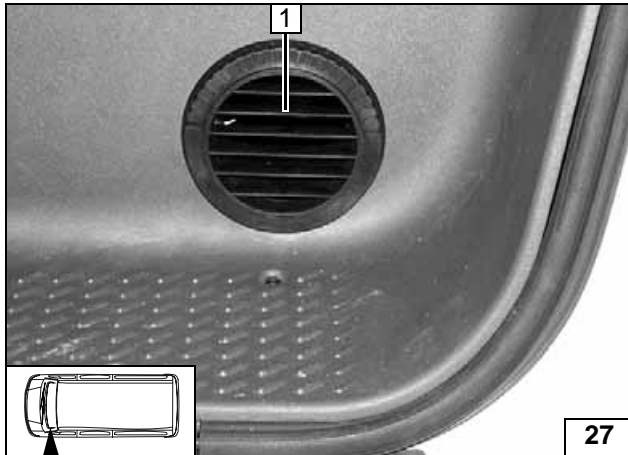
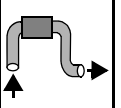

Mount air outlet grid **1** on pass through and engage (close off flush toward outside)!



**Installing grid**

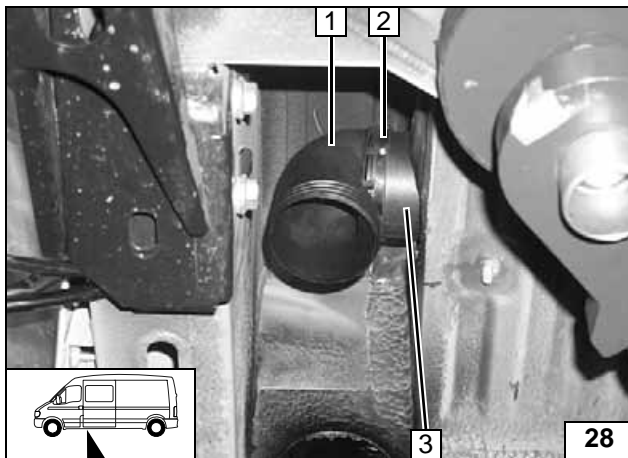

Mount hot air elbow 90° **1** on pass through **3**, align downward and fasten with 3 self-tapping screws **2**.



**Hole in floor panel**

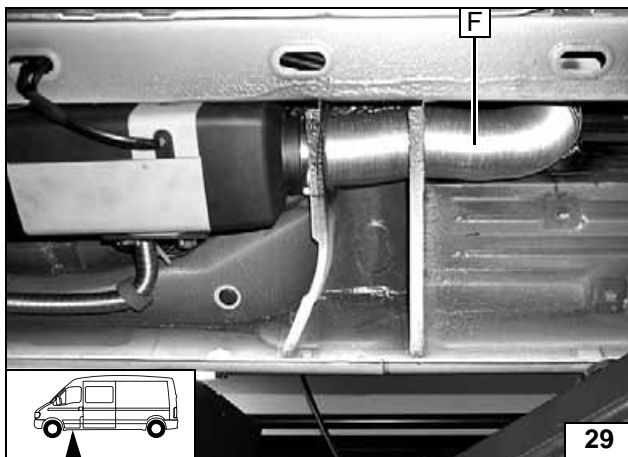

Guide 385 mm long flexible tube **F** through prepared hole, mount on heater unit inlet and on hot air elbow and fasten with hose clamps.



**Installing flexible tube**

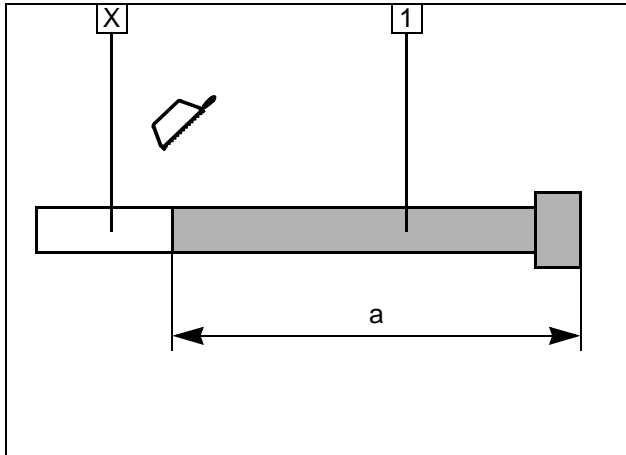

## Exhaust system

- 1 Exhaust pipe  
a = 450 mm  
Discard section X

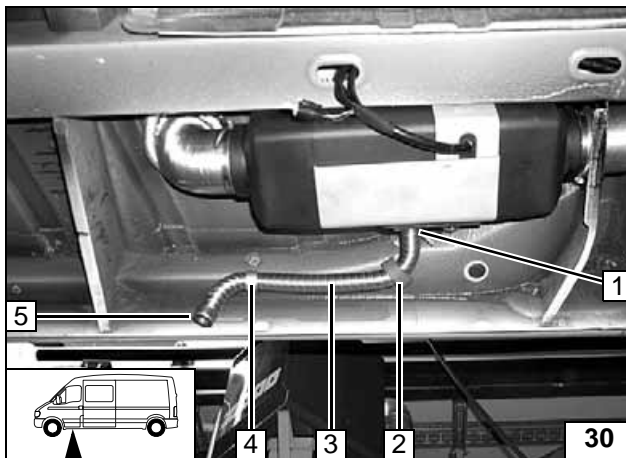

- 3 Exhaust pipe
- 1 Hose clamp
- 2 Push on red (rt) rubber isolator and position
- 4 P-clamp, M6x20 bolt on existing threaded hole
- 5 Shape end section as shown

Preparing  
exhaust  
pipe

Installing  
exhaust  
pipe

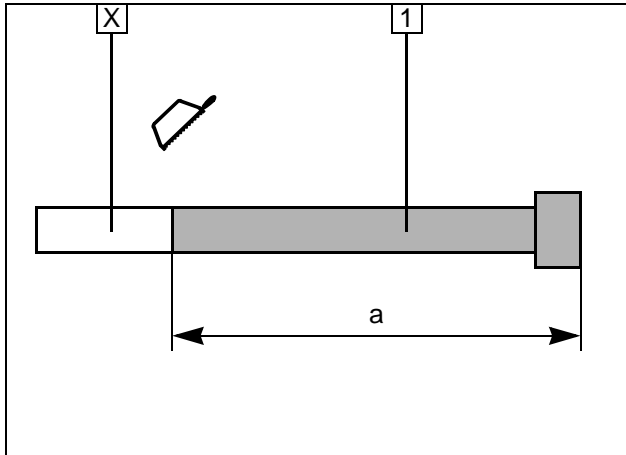
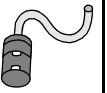

## Combustion air

1 Combustion air pipe  
 a = 450 mm  
 Discard section X

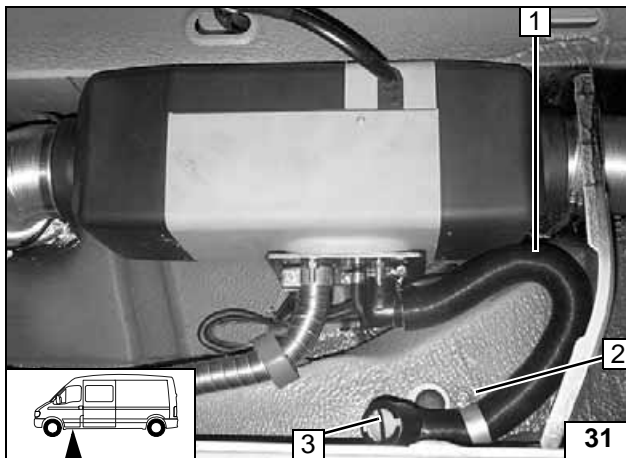

Guide wiring harness of metering pump through groove in combustion-air intake connection piece.

Mount combustion-air intake pipe 1 on combustion-air intake connection piece and fasten with hose clamp.

Drill 4 mm dia. hole in frame side member at position 2. Route combustion-air intake pipe 1 as shown and fasten on frame side member with p-clamp and self-tapping screw 2.

Mount end cap 3 on combustion-air intake pipe.

Preparing combustion air pipe



Installing intake pipe

### Note:

When using a Webasto water heater and a Webasto air heater together, the exhaust pipe of the water heater must be routed along the left-hand side sill.

Ensure sufficient spacing between the exhaust pipe of the water heater and the combustion-air intake pipe of the air heater.



## Fuel Connection

### CAUTION!

Open the vehicle's fuel tank cap, ventilate the tank and then re-close the tank lock.

Catch any fuel running off with an appropriate container.

Install fuel line and metering-pump wiring harness so that they are protected against stone impact. Unless specified otherwise, always fasten using cable ties.

Mount the fuel line and wiring harness with rub protection on sharp edges.

### WARNING!

The fuel line and wiring harness are routed to the metering pump in as shown in the wiring harness routing diagram.

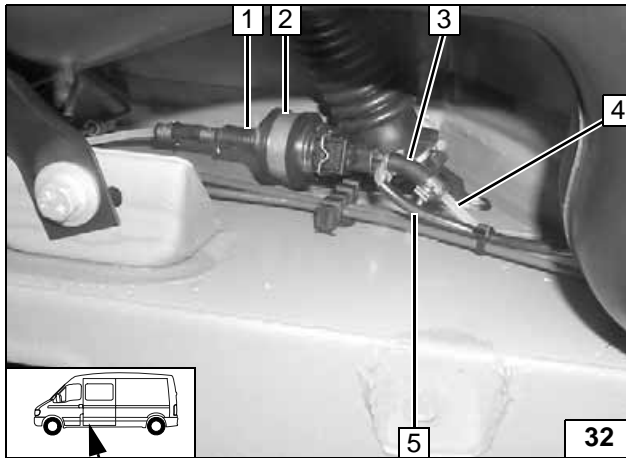

Ensure proper installation position of metering pump **1**, see "Installation Instructions".

Remove original vehicle screw of fuel-tank line bracket and discard. Insert silent block into threaded hole.

Fuel line from heater unit **4** on pressure side of metering pump [side with connector].

**2** Rubber-coated p-clamp, flanged nut on silent block

**3** Hose section, 10 mm dia. hose clamps [2x]

**5** Wiring harness of metering pump, single-wire seal, tab connector, connector housing

Route Mecanyl fuel line and wiring harness of metering pump along right-hand frame side member to cross member and fasten to existing clips of brake lines. Cut off 1,200 mm of protective hose provided. Install Mecanyl fuel line together with wiring harness of metering pump in 1,200 mm protective hose.

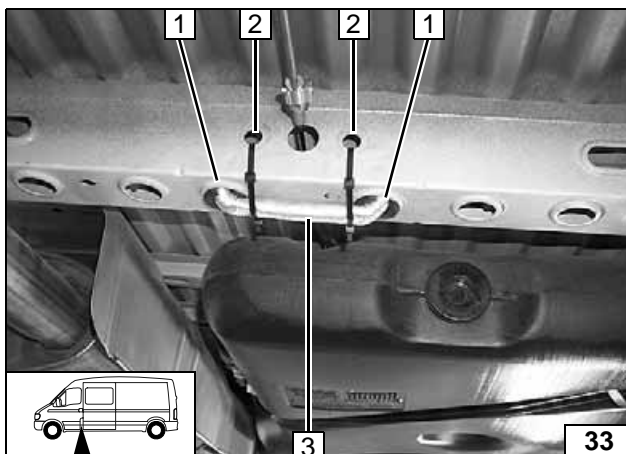

Route Mecanyl fuel line and wiring harness of metering pump in protective hose **3** in cross member behind fuel tank to left-hand side of vehicle. When doing so, route protective hose past parking brake guide by routing out through openings in cross member and then back in again. Insert cut-open protective rubber plugs in both openings **1**. Fasten protective hose with cable ties **2** [2x] as shown.



**Installation location of metering pump**



**Installing lines**



**Installing lines**



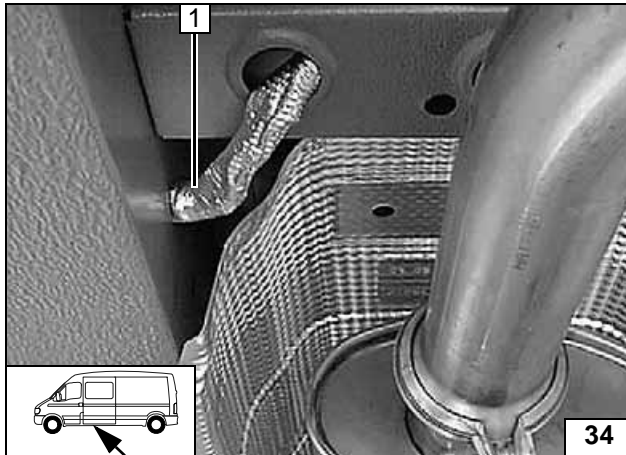

Route protective hose 1 out of cross member as shown and pull wiring harness of metering pump into frame side member together with Mecanyl fuel line.



**Installing lines**

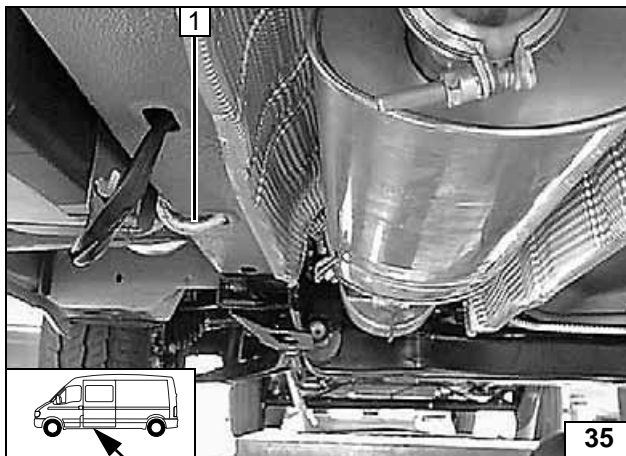

Route wiring harness of metering pump out of frame side member together with Mecanyl fuel line as shown. Push remaining 300 mm long piece of protective hose 1 onto wiring harness of metering pump and Mecanyl fuel line. Route protective hose over hood of heater unit to fuel inlet of heater unit.



**Installing lines**

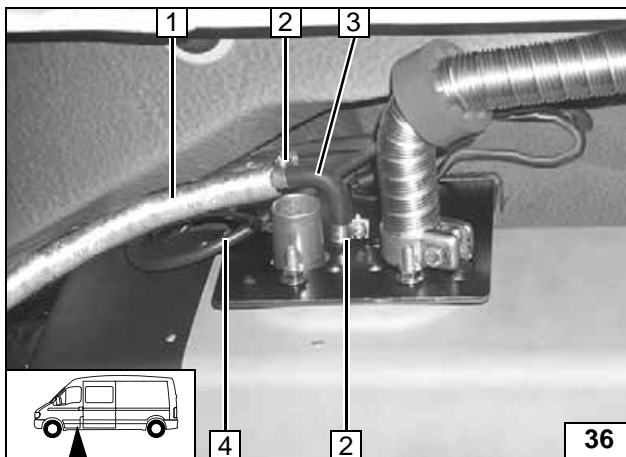

Ensure sufficient spacing of Mecanyl fuel line, wiring harness of metering pump and protective hose to exhaust pipes and to hot air outlet.

- 3 90° molded hose
- 1 Mecanyl fuel line in protective hose
- 2 10 mm dia. hose clamps [2x]
- 4 Wiring harness of metering pump, single-wire seal, tab receptacles, connector housing



**Connection on heater unit**

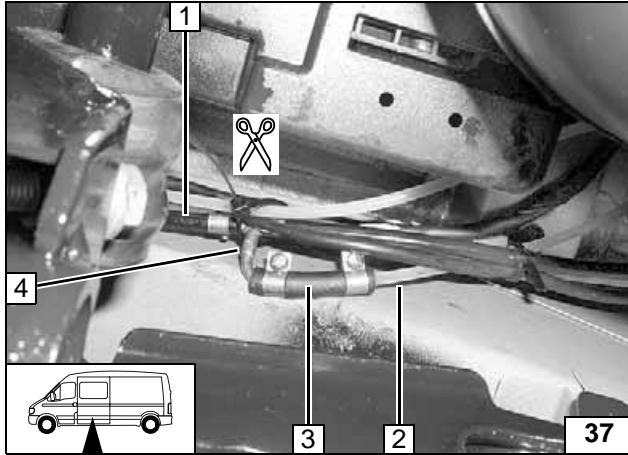

Cut off fuel return line as shown.

- 1 Fuel return line, 8 mm dia. hose clamps [2x]
- 4 Fuel standpipe
- 2 Remaining end of Mecanyl fuel line
- 3 Hose section, 10 mm dia. hose clamps [2x].



**Removing fuel**

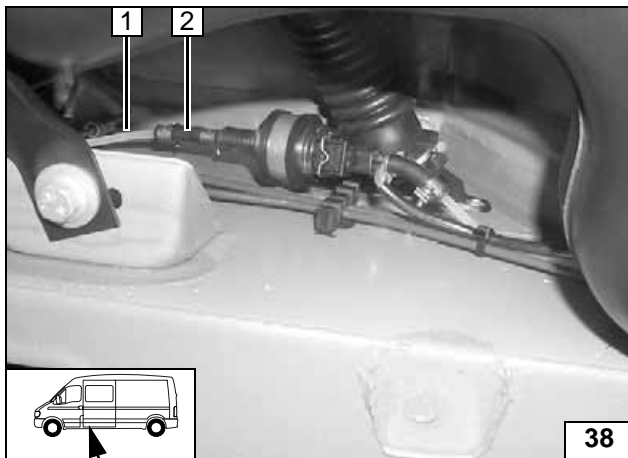

Fuel line from fuel standpipe 1 on intake side of metering pump [side without connector]. Check the position of the components; adjust if necessary. Check that they have free clearance.

- 2 Hose section, 10 mm dia. hose clamps [2x].



**Connection to metering pump**



## Electrical Connections

### Fuse holder

- 4 2.5 mm dia. hole, retaining plate for fuse holder, 3.5x13 self-tapping screw
- 3 Fuse holder mounted
- 2 Ground wire on negative battery terminal
- 1 Positive wire on positive battery terminal

### Wiring routing

Route wiring harness of heater unit from underbody through existing opening in battery box (rear left).  
Route wiring harness of digital timer 1 under floor cover to center console.

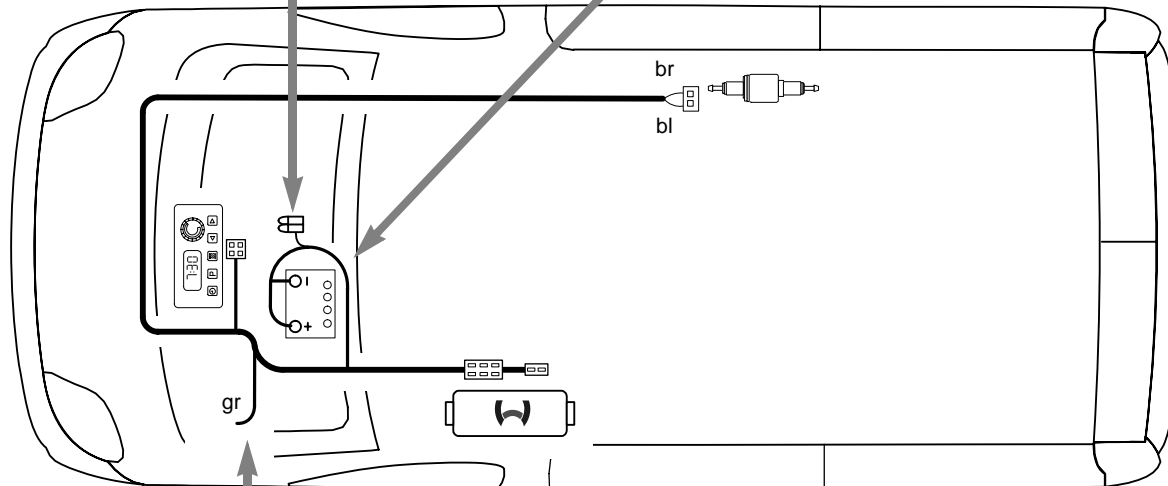
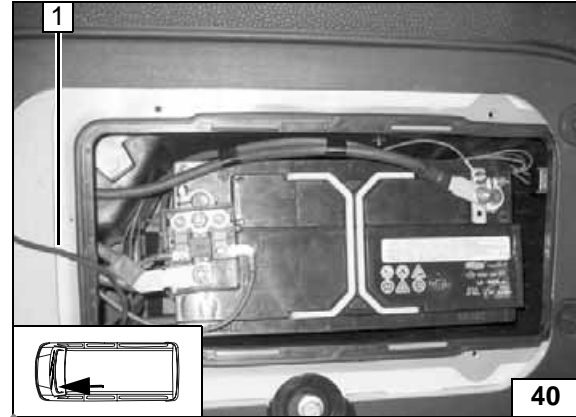
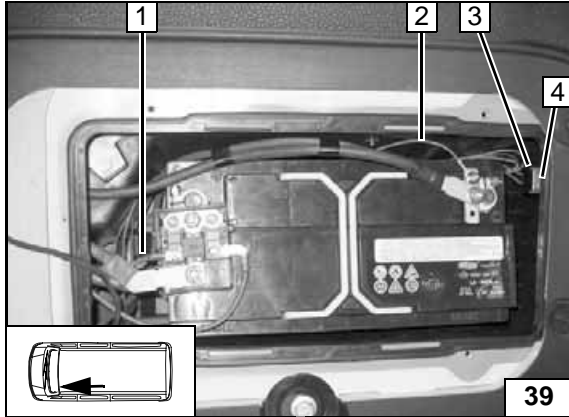

Wiring harness installation diagram

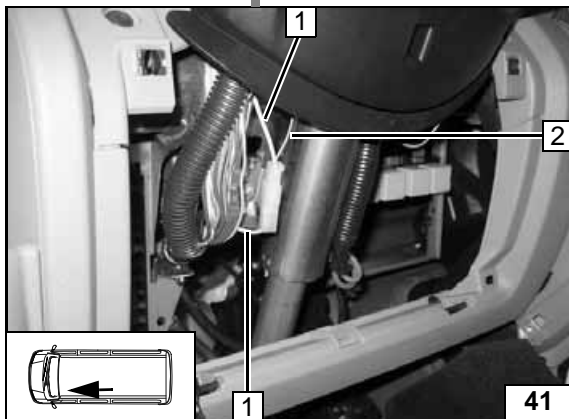

### Connection to lighting of digital timer

Make connections as shown in wiring diagram with blade connectors provided.

- 1 Light blue (hbl) wire from parking light switch (terminal 58)
- 2 Gray (gr) wire from preassembled wiring harness



## Connection Diagram for Combination Timer and Telearstart

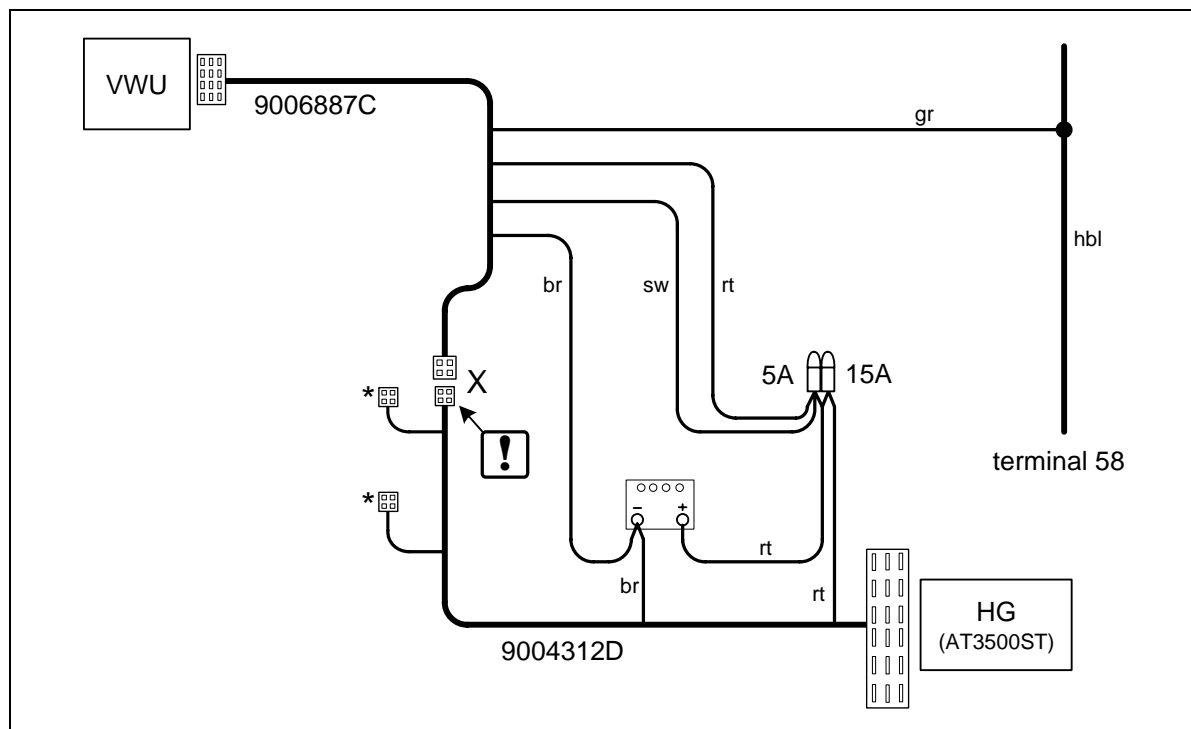

Connection Diagram for Combination Timer

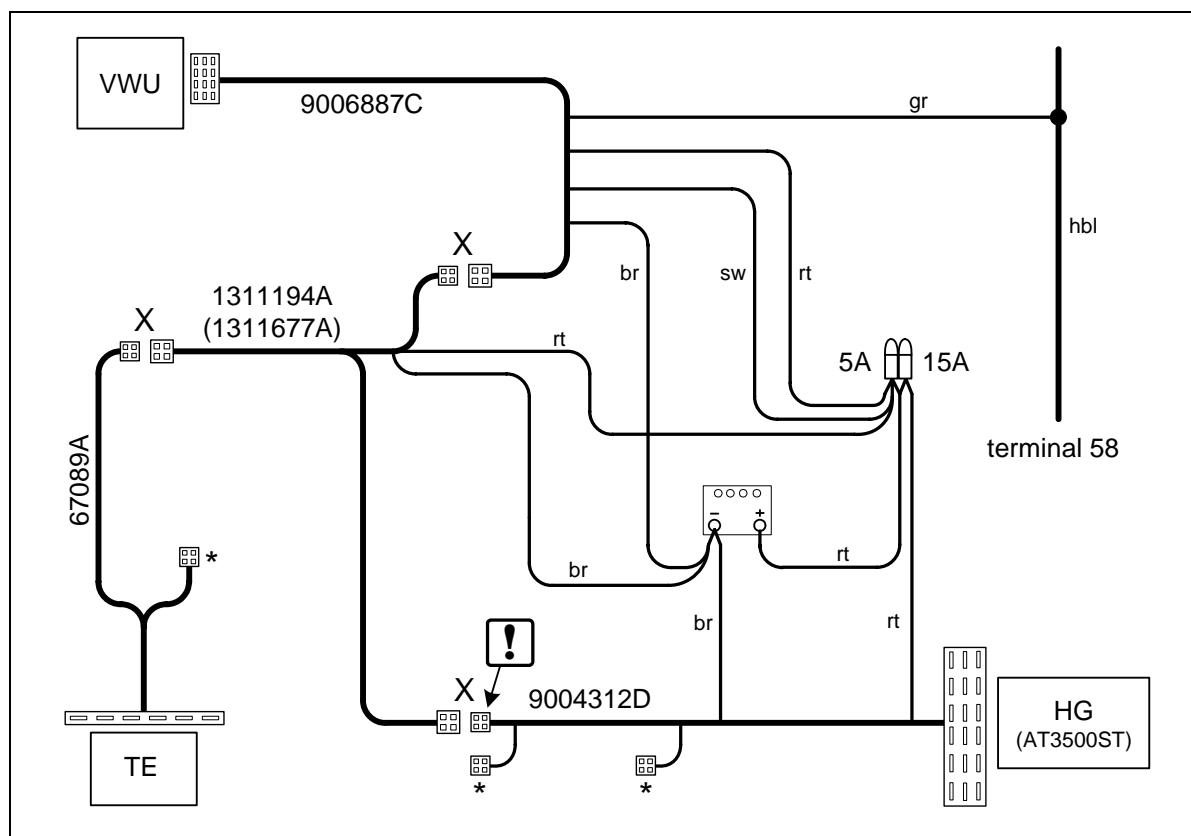

Connection Diagram for Combination Timer + Telearstart

Components of		Cable colors		Symbols	
HG	Heater unit	rt	red	*	Connectors not used!
TE	Telearstart receiver	gr	gray	!	"Potentiometer" connector!
VWU	Digital timer	sw	black		
		br	brown	X	Connect identical colors of connectors!
		hbl	light blue		

Legend

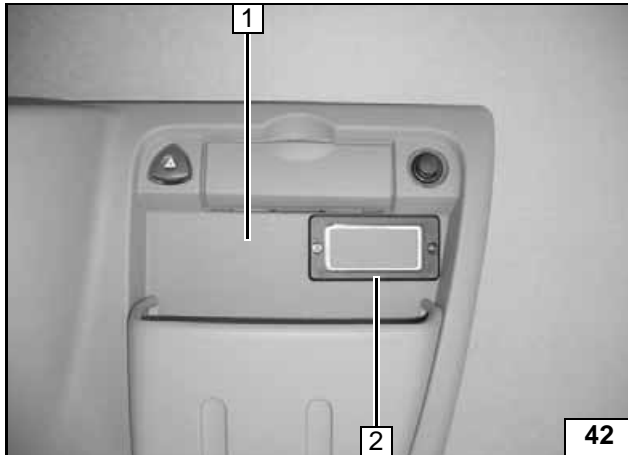

## Digital/combination timer

Use installation frame 2 as template. Copy hole pattern [2x] for screwing on and cutout to center console 1.  
Cut out 2 4 mm dia. holes in center console and hole pattern for combination timer insert



**Preparing combination timer**

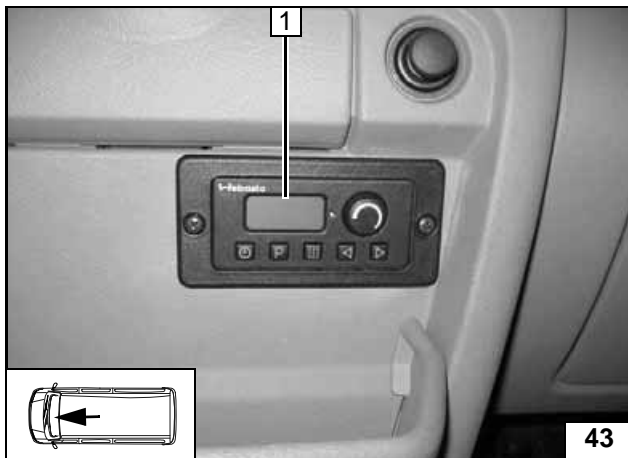

1 Combination timer

**Installing combination timer**

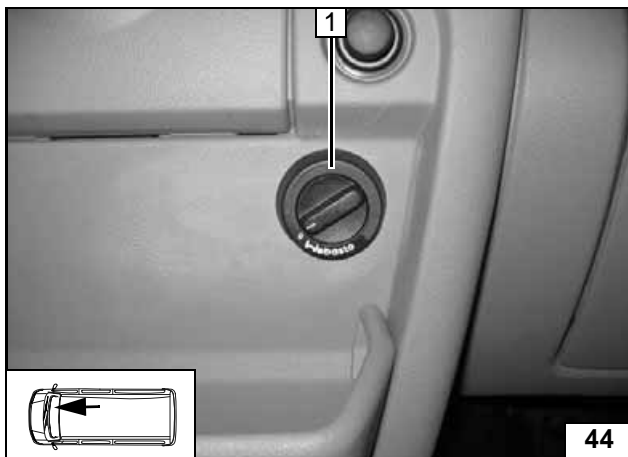

## Heater control option

1 12 mm dia. hole, heater control in center console



**Installing heater control**

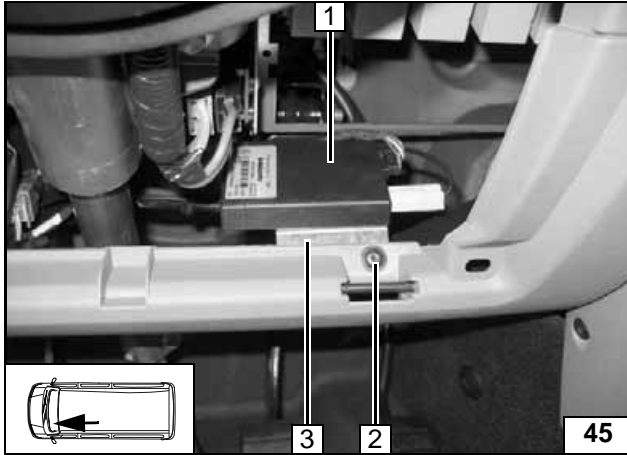

## Remote option (Telestart)

- 3 Bracket, align as shown
- 2 Original vehicle bolt
- 1 Receiver



Installing receiver

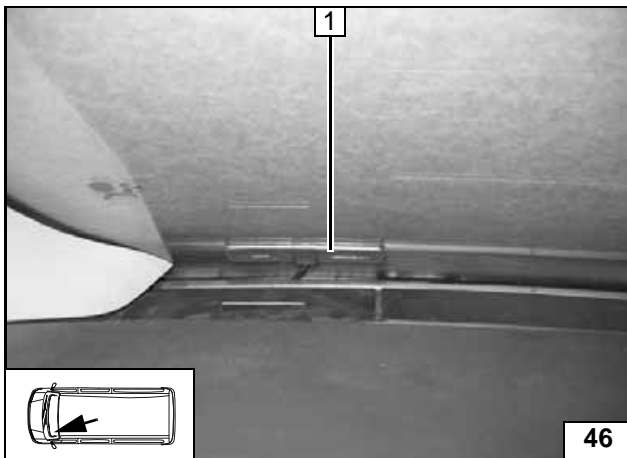

- 1 Antenna

Installing antenna

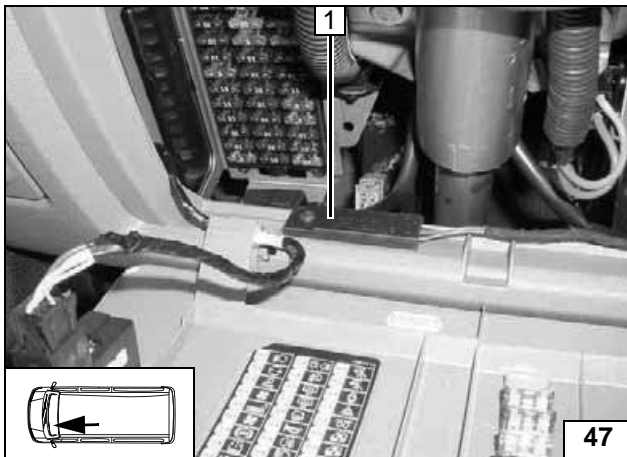

## Temperature sensor for HTM100 only

- 1 Fasten temperature sensor with suitable means

Installing temperature sensor

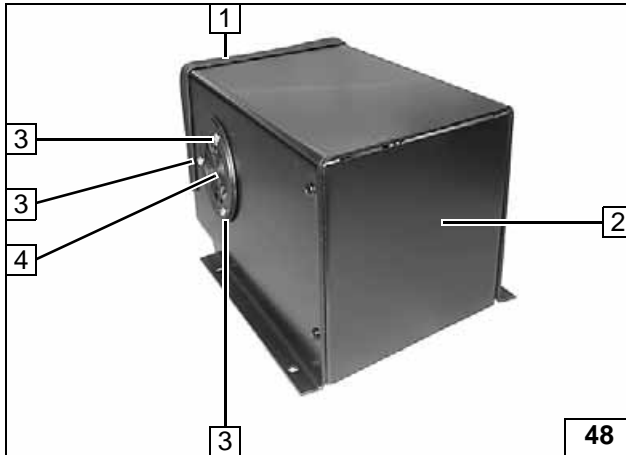
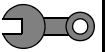

## Installing trim parts

- 2 Kick guard
- 1 Edge protection
- 4 Outlet screen on both sides [2x]
- 3 2.5 mm dia. hole, self-tapping screw 3.5x13 [3x each]

Preparing kick guard

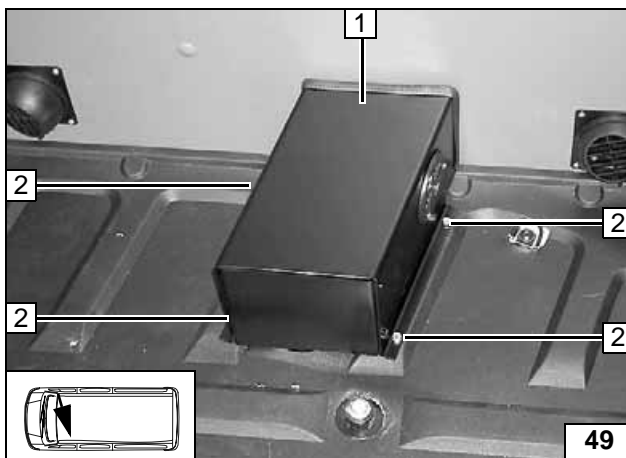

- 1 Kick guard
- 2 M6x16 bolt [4x] on prepared rivet nuts

Installing kick guard

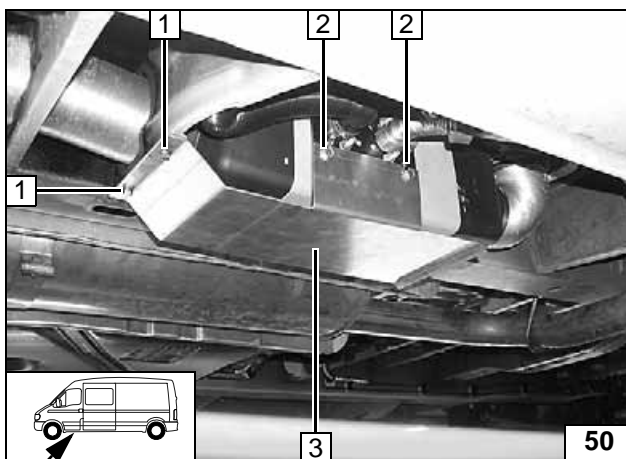

- 3 Heater unit trim
- 2 Mount M6x12 bolt, spring lockwasher [2x each] on rivet nuts
- 1 Drill out 4 mm dia. hole, self-tapping screw 5.5x13; spring lockwasher [2x each]

Installing heater unit trim

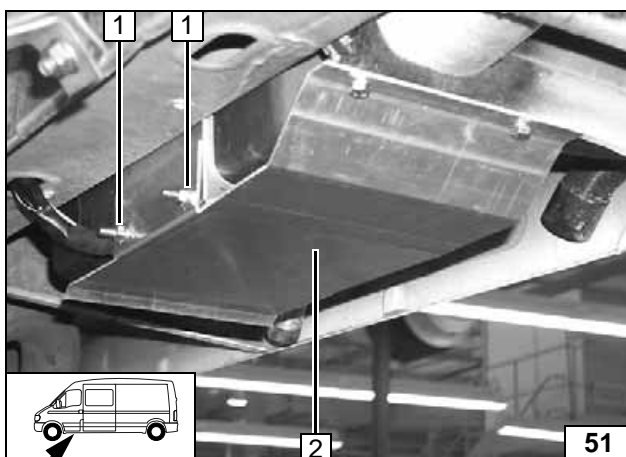

- 2 Heater unit trim
- 1 Flanged nut [2x] on existing stud bolt

Installing heater unit trim



## Final Work

### WARNING!

Reassemble the disassembled components in reverse order.

Check all hoses, hose, spring and Caillau clamps, as well as all electrical connections for firm seating. Secure all loose cables using cable ties.

Spray the heater unit components with anti-corrosion wax (Tectyl 100K, Order No. 111329).

- Connect the battery
- Set the digital timer, teach the Telestart if installed
- Check the proper operation of the air heater, see the operating instructions/installation instructions.
- Attach the "Switch off additional heater before refueling" sticker to the left-hand B-pillar.



# Webasto

*Feel the drive*

Webasto AG  
Postfach 80 - 82132 Stockdorf, Germany - Hotline +49-  
(0)1805-932278  
Hotfax +49-(0)395-5592-353 - <http://www.webasto.de>



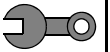

Template for Heater Unit

