

Air Heater Unit



Air Top 2000 ST D Additional Heater e1 00 0022

Installation Instructions

Ford Transit

Diesel
from Model Year 2007
For left-hand drive vehicles only



WARNING!

Hazard warning:

Incorrect installation or repair of Webasto heating systems may cause a fire or result in the emission of carbon monoxide, which can be fatal. Serious or fatal injuries can be caused as a result.

Specialist company training, technical documentation, specialized tools and equipment are required to install and repair Webasto heating and cooling systems.

NEVER attempt to install or repair Webasto heating or cooling systems if you have not successfully completed the company training and thereby acquired the required technical skills, or if you do not have access to the required technical documentation, tools and equipment needed to carry out correct installation and repairs.

ALWAYS follow all Webasto installation and repair instructions and observe all warnings.

Webasto does not accept any liability for defects and damage that are attributable to installation by untrained staff.

Table of Contents

Validity	2	Preassembling heater unit	9
Foreword	2	Installing heater unit	10
Heater units	3	Exhaust system	11
General Instructions	3	Fuel Connection	12
Special tools	3	Combustion air	14
Explanatory Notes on Document	4	Final Work	15
Preliminary Work	5	Template for Perforated Bracket A	16
Heater unit installation location	5	Template for Perforated Bracket B	17
Preparing installation location	6		
Installing blade-type fuse holder	8		
Installing heater control	8		
Installing combination timer (option)	8		

Validity

Manufacturer	Model	Type	EG-BE No./ABE
Ford	Transit	F*6	e11 * 2001 / 116 * 0284 * ...

Engine type	Engine model	Output in kW	Displacement in cm ³
QVFA	Diesel	81 / 96	2198

Foreword

These installation instructions apply to Ford Transit vehicles with a Diesel engine from model year 2007 and later, assuming technical modifications to the vehicle do not affect installation, any liability claims excluded.

Vehicles and equipment variants, which are not listed in these installation instructions, have not been tested. However, installation according to these installation instructions may be possible. Depending on the version and the equipment variants of the vehicle, changes may be necessary relative to these "installation instructions" during installation and must be adjusted accordingly.

However, where this is the case the stipulations in the "installation instructions" and "operating and maintenance instructions" for the *Air Top 2000 ST* should be observed.

The installation location of heater controls and the routing of the air ducting parts must be coordinated with the final customer prior to installation!

WARNING!

Original load-bearing components of the vehicle and/or component used for crash safety may not be modified for the hot air and recirculating air ducting!

Heater units

Quantity	Description	Order No.:
1	Delivery scope of <i>Air Top 2000 ST</i> 12V Diesel Ford Transit	1311679A
	or	
1	Installation kit for Ford Transit Diesel <i>Air Top 2000 ST</i> In conjunction with retail accessories	1311683A

Optional heater control either:

Quantity	Description	Order No.:
1	Combination timer	1311691A

General Instructions

Installation should be carried out according to the general, standard rules of technology. Unless specified otherwise, fasten hoses, lines and wiring harnesses to original vehicle lines and wiring harnesses using cable ties.

Sharp edges should be fitted with edge protectors (split-open plastic hose).

Spray unfinished body areas, e.g. drilled holes, with anti-corrosion wax (Tectyl 100K, Order No. 111329).

Special tools

- Torque wrench for 2.0 - 10 Nm

Explanatory Notes on Document

To provide you with a quick overview of the individual working steps, you will find an identification mark on the outside top right corner of the page in question.

Mechanical work



Electrical system



Hot air system

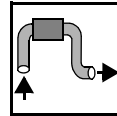

Fuel connection



Exhaust system

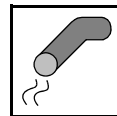

Combustion air



Special features are highlighted using the following symbols:



Specific risk of injury or fatal accidents.



Specific risk of damage to components.



Specific risk of fire or explosion.



Reference to general installation instructions of Webasto components or to the manufacturer's vehicle-specific documents.



Reference to a special technical feature.

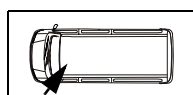
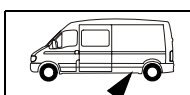

The arrow in the vehicle icon indicates the position on the vehicle and the viewing angle.

Preliminary Work

WARNING!

- Disconnect the battery "earth" or "ground" connection.
- Copy the factory number from the original type label to the duplicate type label.
- Remove years that do not apply from the duplicate label.
- Attach the duplicate label (type label) in the appropriate place.
- Remove the entrance trim on the driver's and front passenger side
- Remove the front passenger seat
- Detach the floor covering on the front passenger side
- Detach the A-pillar trim on the left (only when installing combination timer)
- Open the fuel tank cap, ventilate the tank.
- Close the tank cap again.

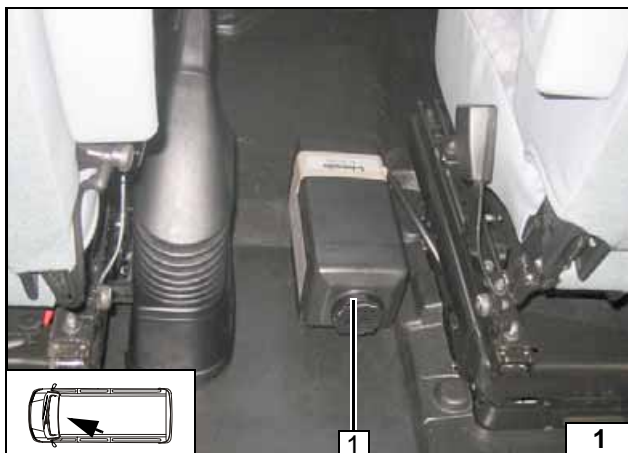

Heater unit installation location

- 1 Heater unit

Installation location

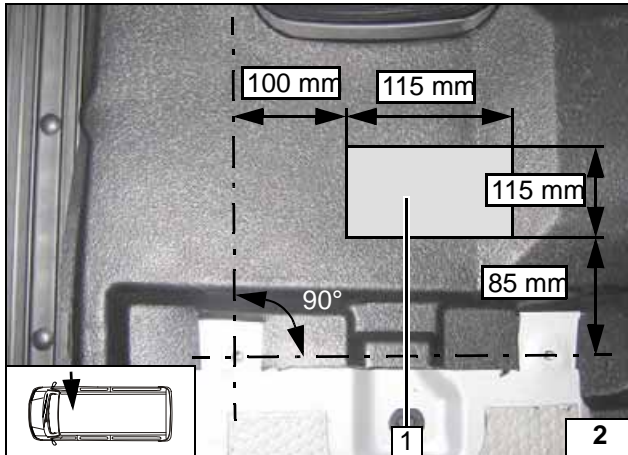
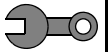

Preparing installation location

Fold up floor covering toward driver's side. Cut out floor covering **1** as shown.



Cutting out floor covering

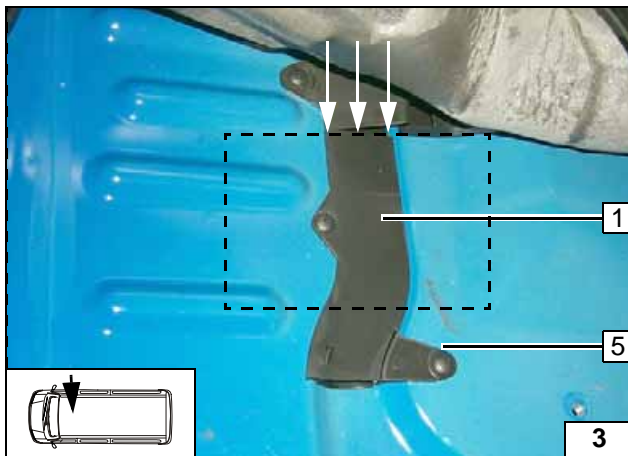

Cut off cable duct **1** at marking (arrows) and discard. Cut out insulation mat in area of bracket (shaded field) if installed on vehicle.



Cutting cable duct to shape

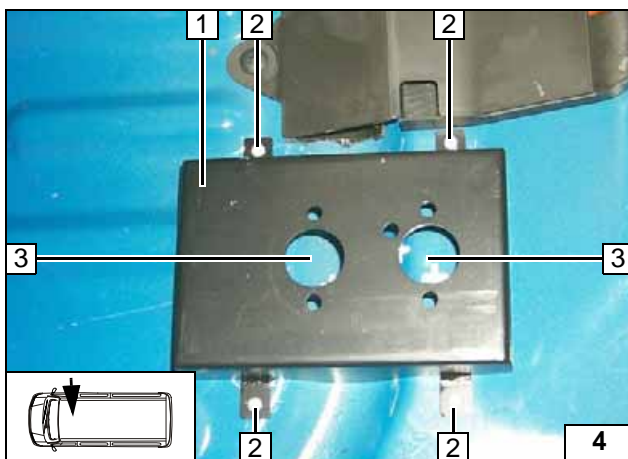

- 1 Lay on bracket and align
- 2 Copy hole pattern [4x] for fastening bracket
- 3 Copy center point of hole [2x] for heater-unit pass through

Copying hole pattern

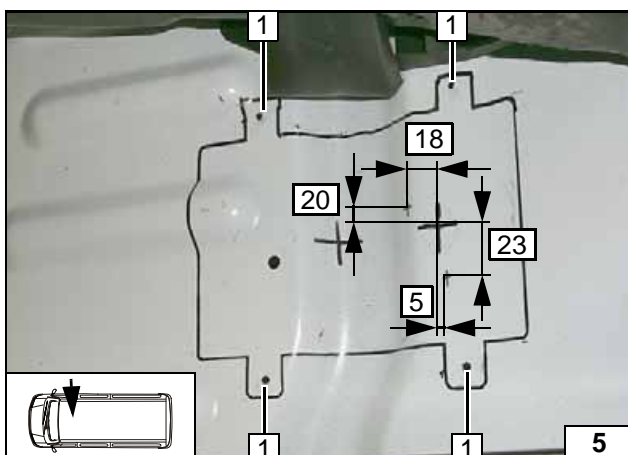

Remove bracket. Copy dimensions to floor panel.

- 1 7 mm dia. hole [4x] for fastening bracket



Copying dimensions

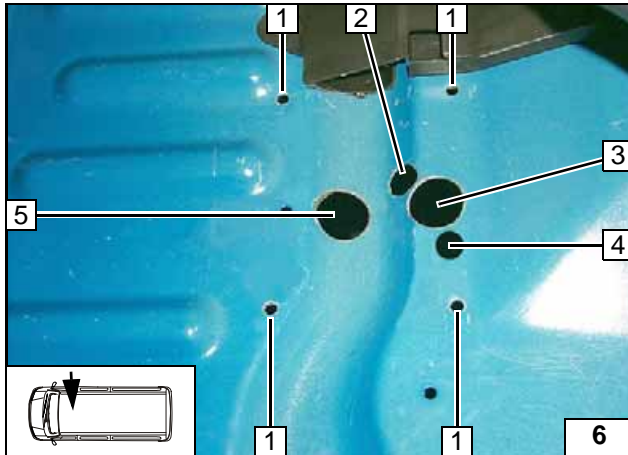
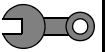

A bar of at least 2 mm must remain between holes **2** and **3** and **3** and **4**!
Use corrosion protection!

- 1** 7 mm dia. hole [4x] for fastening bracket
- 2** Drill 18 mm dia. hole for fuel line
- 3** Drill 30 mm dia. hole for combustion-air intake pipe
- 4** Drill 14 mm dia. hole for metering pump wiring harness
- 5** Drill 46 mm dia. hole for exhaust pipe

Holes in floor panel

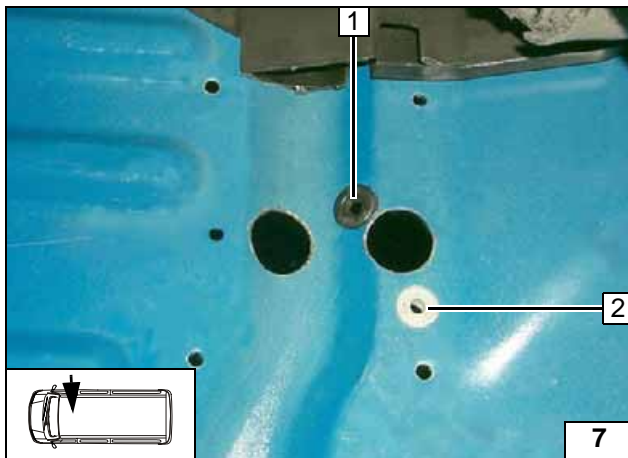

- 1** Mount 18 mm dia. protective rubber plug
- 2** Mount 14 mm dia. protective rubber plug

Mounting protective rubber plugs

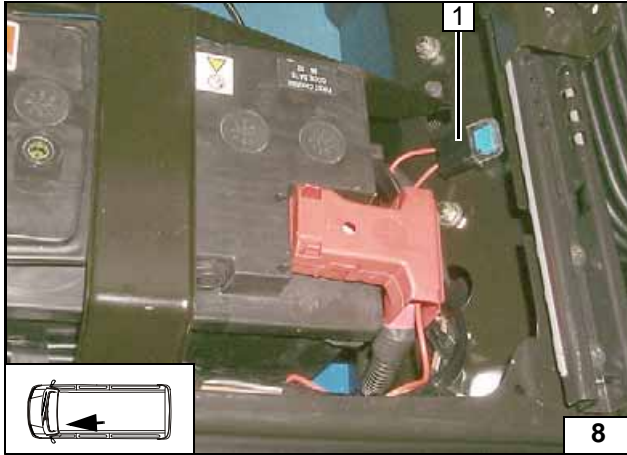

Installing blade-type fuse holder

- 1 2.5 mm dial hole; self-tapping screw 3.5x13; fastening plate for blade-type fuse holder on battery box

Installing fuse holder



Route wiring harness of heater unit through cable duct to installation location of heater unit. Route wiring harness of heater control under left entrance trim toward front to instrument panel.

- 1 Ground wire on negative battery terminal
- 2 Positive wire on positive battery terminal



Installing wiring harnesses



Installing heater control

- 1 12 mm dia. hole, heater control



Installing heater control

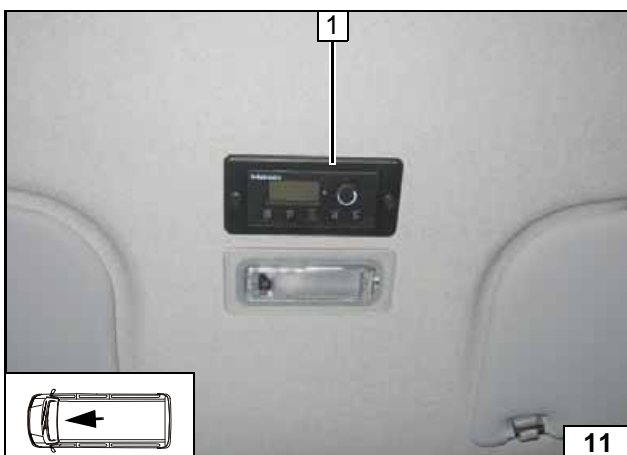

Installing combination timer (option)

Use installation frame as template. Copy hole pattern for fastening [2x] and cutout.

- 1 Combination timer



Installing combination timer

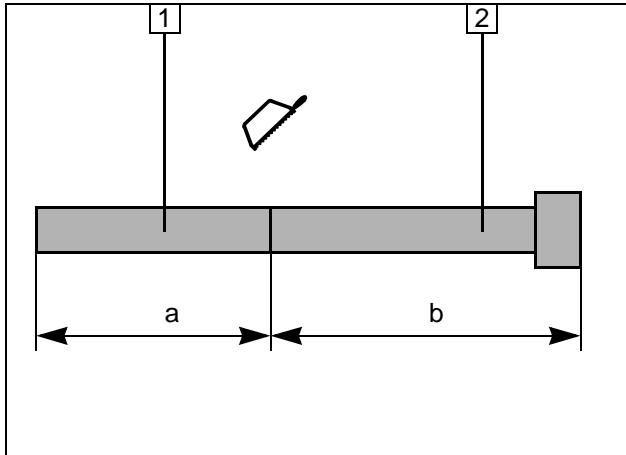
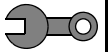

Preassembling heater unit

- 1 Exhaust pipe
a = 650 mm
- 2 Exhaust end section
b = 50 mm

Preparing exhaust pipe

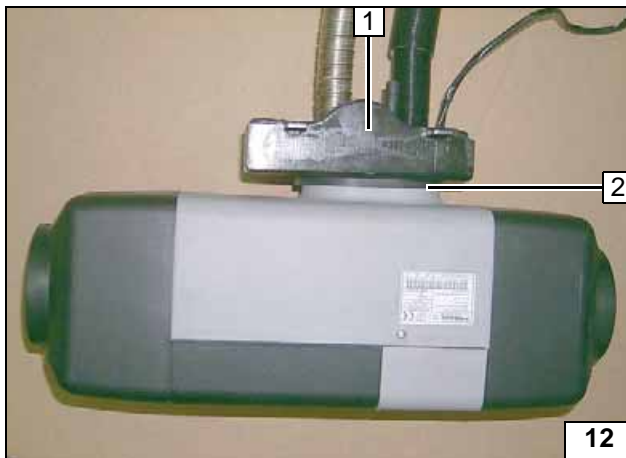

First push on gasket **2**. Install bracket with washers and nut on heater unit as described in installation instructions.



- 1 Bracket

Installing bracket

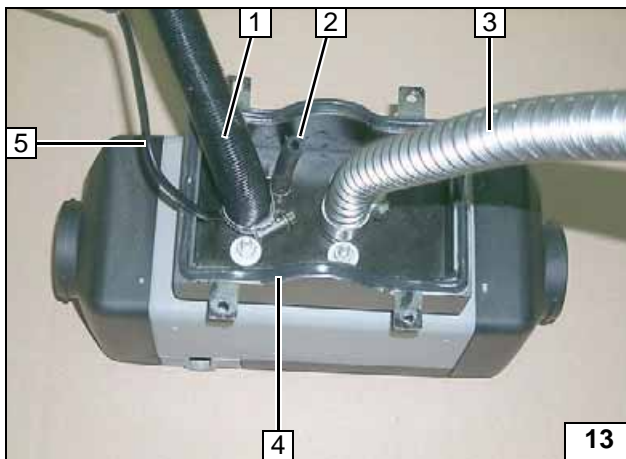

First route wiring harness of metering pump **5** through groove in combustion-air intake connection piece.



- 1 Combustion-air intake pipe, hose clamp
- 2 Hose section (cut to length to 70 mm), 10 mm dia. hose clamp
- 3 Exhaust pipe, hose clamp
- 4 Lay sealing cord in groove around circumference of heating unit bracket

Connecting heater unit

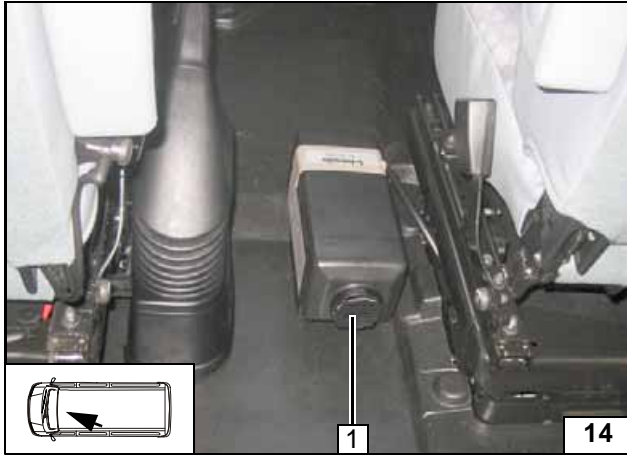
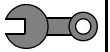

Installing heater unit

Check sealing cord for proper seating. Position heater unit with bracket **1** on floor panel.



Mounting heater unit

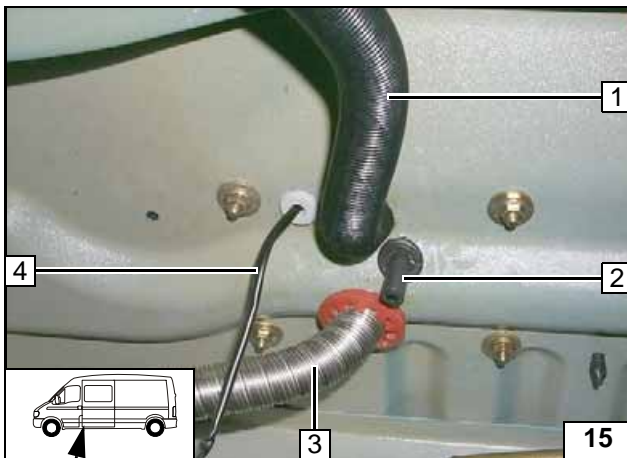

Route exhaust pipe **3**, combustion-air intake pipe **1**, wiring harness of metering pump **4** and hose section **2** through prepared holes.



Installing lines

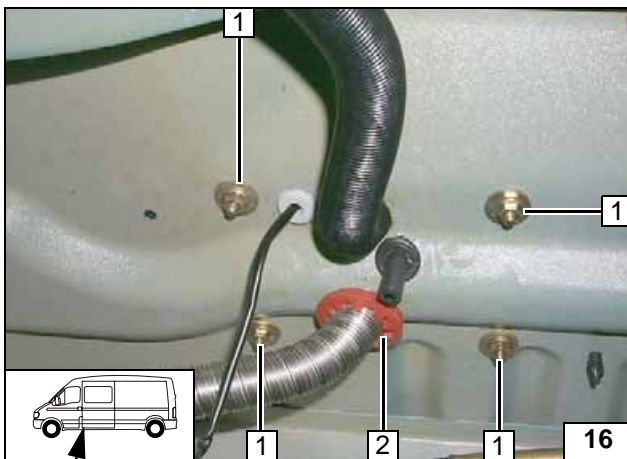

Push red (rt) rubber isolator **2** onto exhaust pipe and mount in hole.

1 M6x20 bolt, large diameter washer, M6 flanged nut [4x each]



Installing heater unit

WARNING!

Sealing cord and rubber gasket must be replaced after every removal!



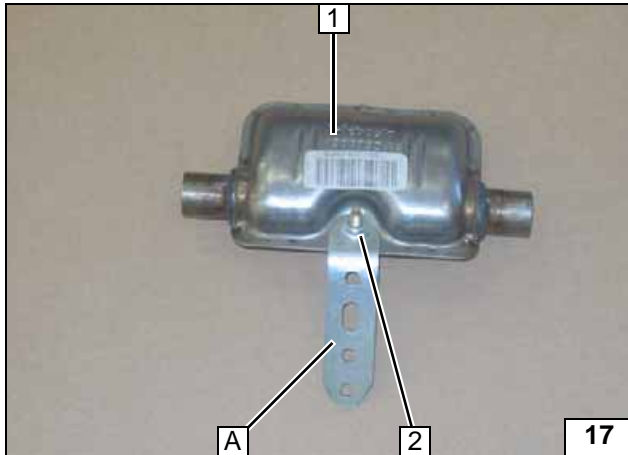
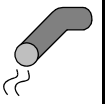

Exhaust system

Angle down perforated bracket **A** according to template.

- 1 Muffler
- 2 M6x20 bolt, flanged nut



Preassembling muffler

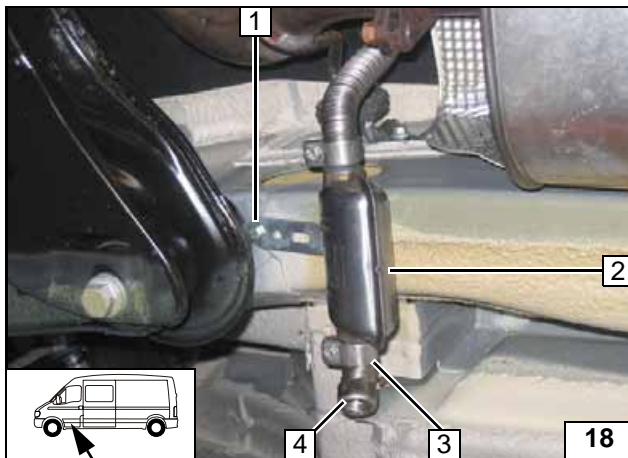

Use existing hole in frame side member for fastening.

- 1 Mount M6x16 bolt, flanged nut in existing hole
- 2 Preassembled muffler
- 3 Hose clamp
- 4 Exhaust end section



Installing muffler

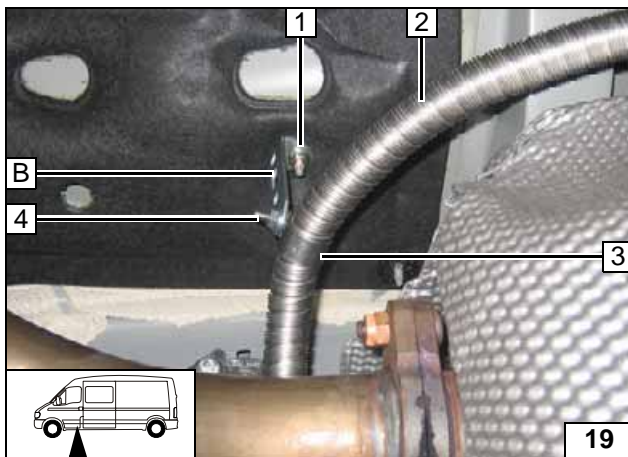

Remove lock washer from position 1. Angle down perforated bracket **B** according to template.

- 1 Original vehicle stud bolt
- 2 Exhaust pipe
- 3 P-clamp
- 4 Mount M6x20 bolt, flanged nut on perforated bracket **B**



Installing exhaust pipe



- 1 Exhaust pipe
- 2 Hose clamp

Installing exhaust pipe



Fuel Connection

CAUTION!

Open the vehicle's fuel tank cap, ventilate the tank and then re-close the tank lock.

Catch any fuel running off with an appropriate container.

Install fuel line and metering-pump wiring harness so that they are protected against stone impact. Unless specified otherwise, always fasten using cable ties.

Mount the fuel line and wiring harness with rub protection on sharp edges.

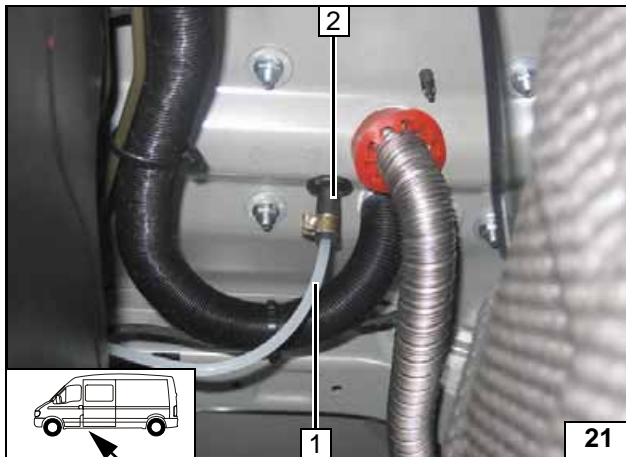

- 1 Mecanyl fuel line
- 2 Mount 10 mm dia. hose clamp on hose section

Con-
nection on
heater unit

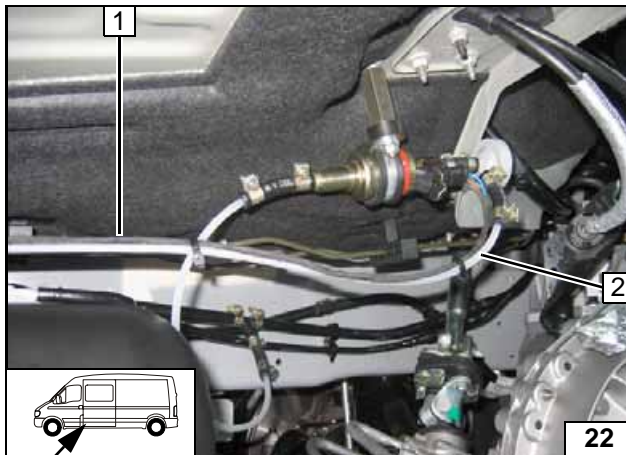

Ensure proper installation position of metering pump, see "Installation Instructions".
Installation location in front of vehicle fuel tank!

- 1 Metering pump wiring harness
- 2 Fuel line from heater unit



Installation
location of
metering
pump

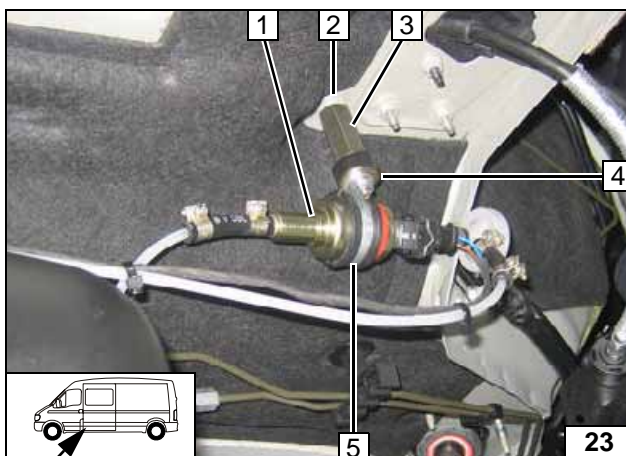

- 1 Metering pump
- 2 Original vehicle stud bolt
- 3 Spacer nut on stud bolt
- 4 Silentblock, flanged nut
- 5 Rubber-coated pipe clamp

Installing
metering
pump

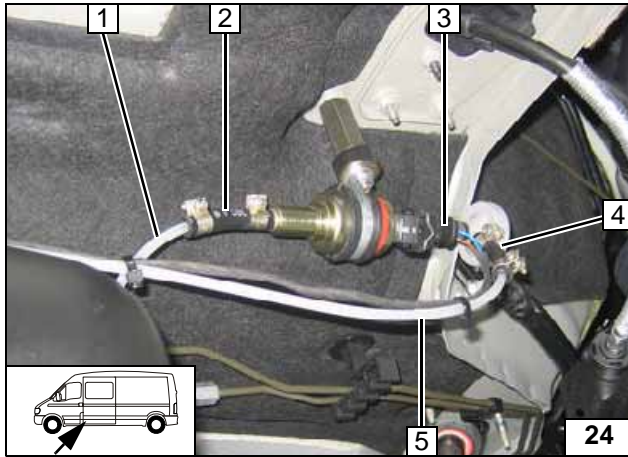

Fuel line from heater unit **5** on pressure side of metering pump [side with connector]. Fuel line to fuel standpipe **1** on intake side of metering pump [side without connector]. Check the position of the components; adjust if necessary. Check that they have free clearance.

- 2** Hose section, 10 mm dia. hose clamps [2x]
- 3** Wiring harness of metering pump, single-wire seal, tab connector, connector housing
- 4** Hose section, 10 mm dia. hose clamps [2x]

**Con-
necting
metering
pump**

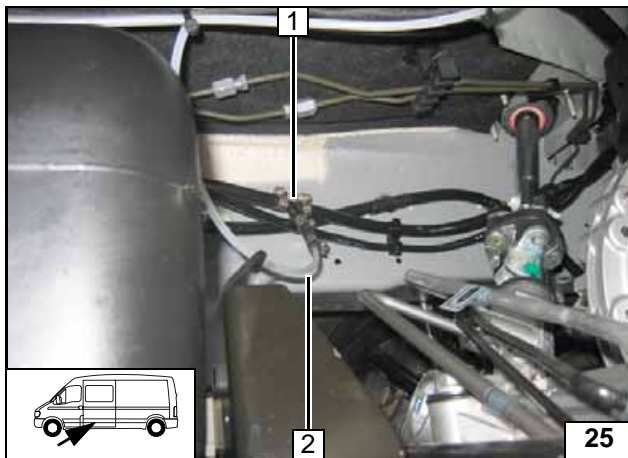

Separate fuel supply line at position **1**. Mount fuel standpipe with 2 12 mm dia. hose clamps in cutting point.

- 2** Fuel line from metering pump, hose section, 10 mm dia. hose clamp [2x] on fuel standpipe

**Removing
fuel**



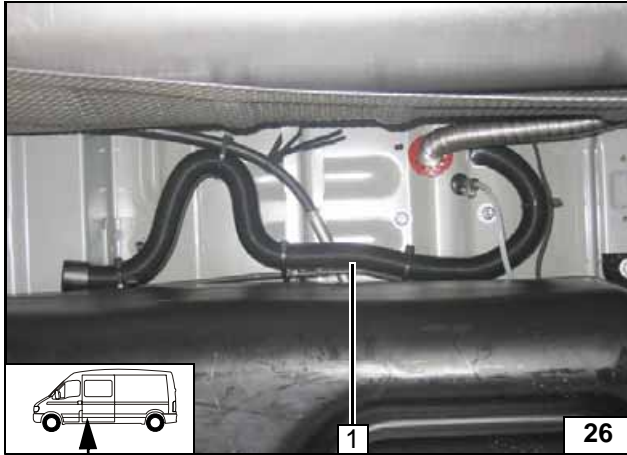
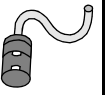

Combustion air

Route combustion-air intake pipe 1 as shown and fasten with cable ties.



Installing intake pipe

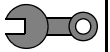

Final Work

WARNING!

Reassemble the disassembled components in reverse order.

Check all hoses, hose clamps and all electrical connections for firm seating.

Secure all loose cables using cable ties.

Spray the heater unit components with anti-corrosion wax (Tectyl 100K, Order No. 111329).

- Connect the battery
- Set the digital timer.
- Check the proper operation of the air heater, see the operating instructions/installation instructions.
- Attach the "Switch off additional heater before refueling" sticker to the left-hand B-pillar.



 **Webasto**

Feel the drive

Webasto AG
Postfach 80 - 82132 Stockdorf, Germany - Hotline +49-
(0)1805-932278
Hotfax +49-(0)395-5592-353 - <http://www.webasto.de>

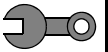

Template for Perforated Bracket A

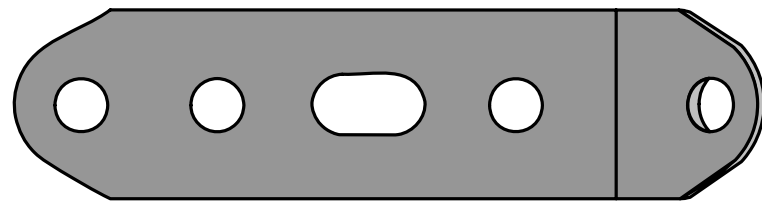
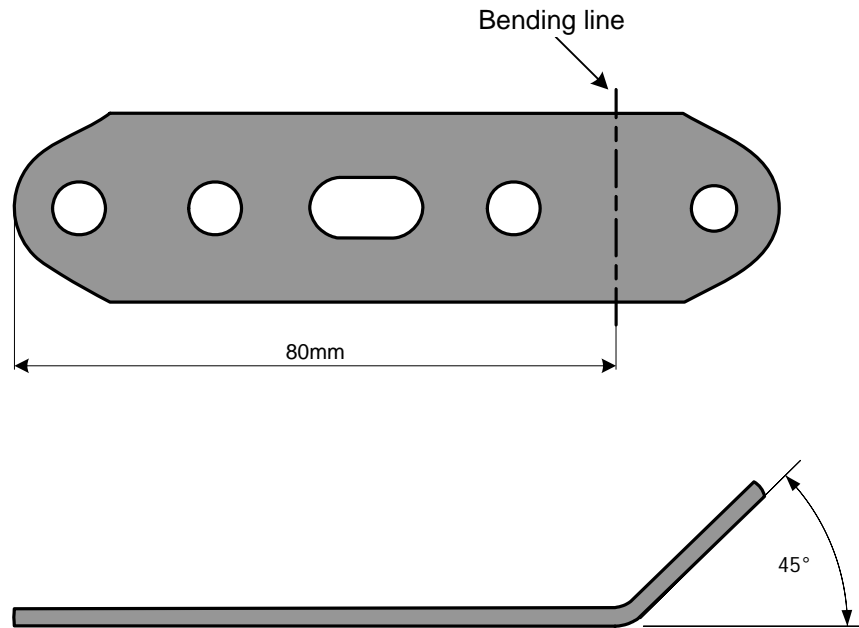

100 mm



Scale 1:1

Compare the size of the printed version with dimension lines.
Permitted tolerance a maximum of 2%.

Set the printer settings to "no margin" or "minimize margins" and 100% of the normal size.

100 mm

0

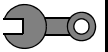

Template for Perforated Bracket B

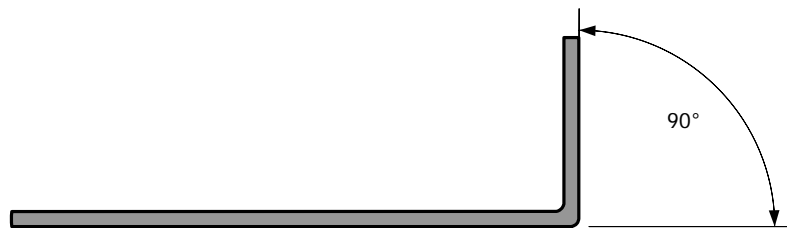
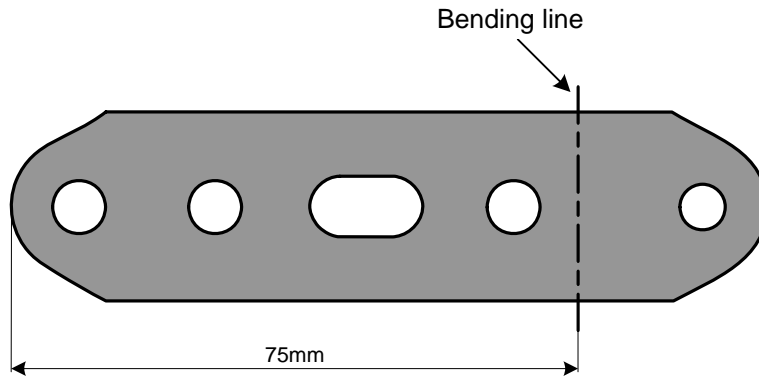

100 mm



Scale 1:1

Compare the size of the printed version with dimension lines.
Permitted tolerance a maximum of 2%.

Set the printer settings to "no margin" or "minimize margins" and 100% of the normal size.

100 mm

0