

# Water Heater Unit



**Thermo Top E Additional Heater** e1 00 0003

**Thermo Top C Additional Heater** e1 00 0002

**Thermo Top P Additional Heater** e1 00 0104

## Installation Instructions

### Audi TT 2.0 TFSI

Gasoline

from Model Year 2006

Left-hand drive vehicle



#### **WARNING!**

Hazard warning:

Incorrect installation or repair of Webasto heating systems may cause a fire or result in the emission of carbon monoxide, which can be fatal. Serious or fatal injuries can be caused as a result.

Specialist company training, technical documentation, specialized tools and equipment are required to install and repair Webasto heating and cooling systems.

NEVER attempt to install or repair Webasto heating or cooling systems if you have not successfully completed the company training and thereby acquired the required technical skills, or if you do not have access to the required technical documentation, tools and equipment needed to carry out correct installation and repairs.

ALWAYS follow all Webasto installation and repair instructions and observe all warnings.

Webasto does not accept any liability for defects and damage that are attributable to installation by untrained staff.

**Table of Contents**

|                                   |   |   |    |
|-----------------------------------|---|---|----|
| Validity                          | 2 | Preparing installation location         | 10 |
| Heater Unit/Installation Kit      | 3 | Preparing heater unit                   | 10 |
| Foreword                          | 3 | Installing heater unit                  | 12 |
| General Instructions              | 3 | Water                                   | 13 |
| Special Tools                     | 3 | Combustion air                          | 15 |
| Explanatory Notes on Document     | 4 | Fuel                                    | 16 |
| Preliminary Work                  | 5 | Final Work                              | 19 |
| Heater unit installation location | 5 | Operating Instructions for End Customer | 20 |
| Preparing wiring harness          | 6 |   |    |
| Electrical system                 | 7 |   |    |
| Fan controller                    | 8 |   |    |
| Remote option (Telestart)         | 9 |   |    |

**Validity**

| Manufacturer | Model | Type | EG-BE No./ABE              |
|--------------|-------|------|----------------------------|
| Audi         | TT    | 8J   | e1 * 2001/116 * 0369 * ... |

| Engine type | Engine model | Output in kW | Displacement in cm <sup>3</sup> |
|-------------|--------------|--------------|---------------------------------|
| BWA         | Gasoline     | 147          | 1984                            |

Vehicle and engine types, equipment variants and national specifications not listed in these installation instructions have not been tested. However, installation according to these installation instructions may be possible.

Information on technical specifications, design equipment, materials, warranties and external appearance refer to the time period in which this installation documentation was published. Webasto AG reserves the right to make changes (including changes for the technical further development of individual model measures).

The installation location of a digital timer and summer/winter switch should be confirmed with the end customer before installation.

## Heater Unit/Installation Kit

| Quantity | Description                                    | Order No.:     |
|----------|--|----------------|
| 1        | Retail accessories with desired heater control | See price list |
| 1        | Installation kit for Audi TT 2.0 TFSI Gasoline | 1312350A       |

### Heater unit recommended for the respective vehicle class:

| Vehicle                       | Heater unit  |
|-------------------------------|--------------|
| Compact car                   | Thermo Top E |
| Mid-size car, station wagon   | Thermo Top C |
| Full-size car, van, offroader | Thermo Top P |

The selection of the heater unit is based on the passenger compartment size of the vehicle and the level of comfort required by the customer!



## Foreword

These installation instructions apply to Audi TT 2.0 TFSI Gasoline vehicles - for validity, see page 2 - from model year 2006 and later, assuming technical modifications to the vehicle do not affect installation, any liability claims excluded. Depending on the vehicle version and equipment, modifications may be necessary during installation with respect to these installation instructions.

However, the stipulations in the "installation instructions" and "operating and maintenance instructions" for the *Thermo Top C/P/E* must always be observed.

The corresponding rules of technology and any information from the vehicle manufacturer should be observed during the installation work.

## General Instructions

Installation should be carried out according to the general, standard rules of technology. Unless specified otherwise, fasten hoses, lines and wiring harnesses to original vehicle lines and wiring harnesses using cable ties.

Sharp edges should be fitted with edge protectors (split-open plastic hose).

Spray unfinished body areas, e.g. drilled holes, with anti-corrosion wax (Tectyl 100K, Order No. 111329).

## Special Tools

- Torque wrench for 2.0 - 10 Nm
- Hose clamping pliers
- Metric thread-setter kit

## Explanatory Notes on Document

To provide you with a quick overview of the individual working steps, you will find an identification mark on the outside top right corner of the page in question.

### Mechanical system

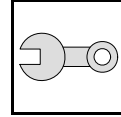

### Electrical system

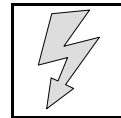

### Water

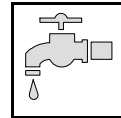

### Fuel

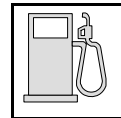

### Exhaust gas

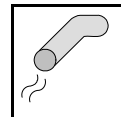

### Combustion air

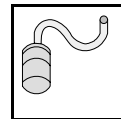

Special features are highlighted using the following symbols:



Specific risk of injury or fatal accidents.



Specific risk of damage to components.



Specific risk of fire or explosion.



Reference to general installation instructions of Webasto components or to the manufacturer's vehicle-specific documents.



Reference to a special technical feature.

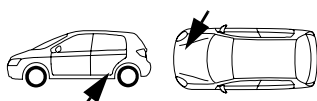

The arrow in the vehicle icon indicates the position on the vehicle and the viewing angle.

All lengths are in mm!

Tightening torque of hose clamps = 2.0 + 0.5 Nm!

Tightening torque of Ejet screws, Ejet studs = 10 Nm!

## Preliminary Work

### WARNING!

- Open the fuel tank cap, ventilate the tank.
- Close the tank cap again.
- Disconnect the battery "earth" or "ground" connection.
- Depressurize the cooling system.
- Copy the factory number from the original type label to the duplicate type label.
- Remove years that do not apply from the duplicate label.
- Attach the duplicate label (type label) in the appropriate place.
- Remove the air filter together with the intake hose.
- Remove the cover from the fuse and relay carrier in the engine compartment
- Unclip the black fuse bar
- Detach the wheel well trim on the left
- Remove the underride protection on the left
- Remove the rear bench seat
- Open the right-hand fuel sender service lid.
- Remove the radio
- Remove the A/C control panel in accordance with the manufacturers specifications.
- Remove the instrument panel trim on the driver's side.
- Remove the fuse carrier in the passenger compartment and lay it aside (only with Telestart)

Remove page 20 "Operating Instructions for End Customer" and add to the vehicle operating instructions.



### Heater unit installation location

1 Heater unit

Installation  
location

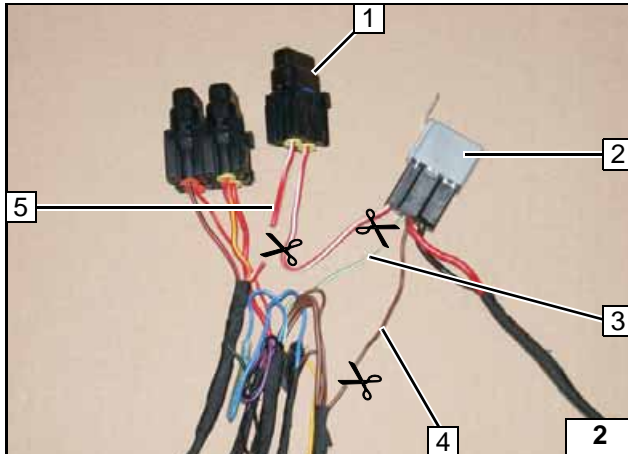
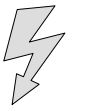

**Preparing wiring harness**

Disconnect red/white (rt/ws) wire 5 of fuse F3 1.  
 Disconnect brown (br) wire 4 of relay K3/30 2.  
 Disconnect green/white (gn/ws) wire 3 of relay K3/86 2.

Fuse F3 1 and relay K3 2 with wiring harness of fan controller are not required.



**Dis-connecting K3 and F3**

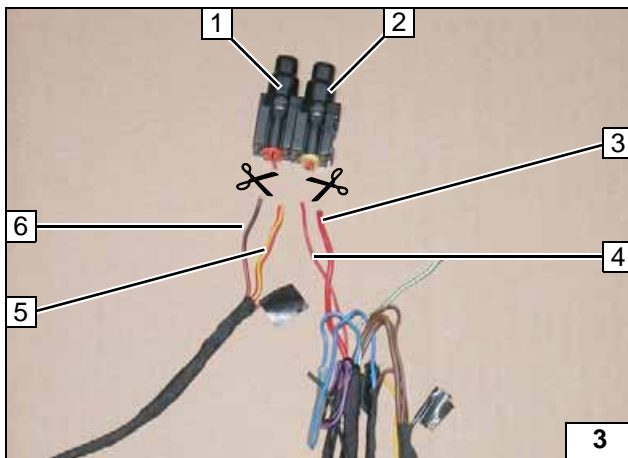

Disconnect red (rt) wire 3 of fuse F1 2.  
 Disconnect red (rt) wire 4 of fuse F2 1.  
 Disconnect red/yellow (rt/ge) wire 5 of fuse F1 2.  
 Disconnect red/black (rt/sw) wire 6 of fuse F2 1.

Remove blade fuse F1, 20 A and F2, 1 A; they will be required later. Crimp on power timer on wire ends 3, 4, 5, 6.



**Dis-connecting fuse F1 and F2**

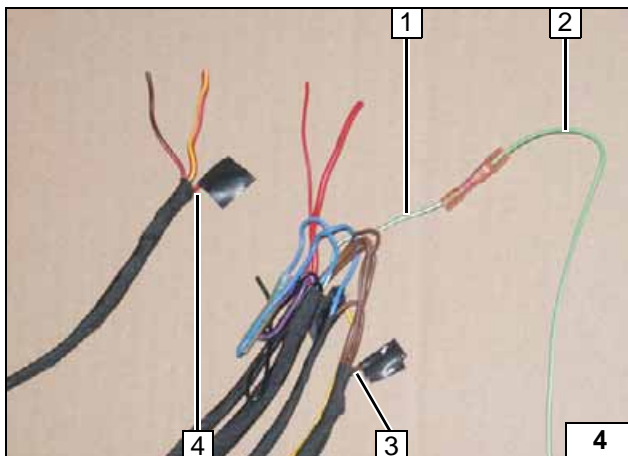

Insulate and tie back brown (br) wire 3 from ground distributor and red (rt) wire 4 from positive distributor.  
 Produce connections as shown in wiring diagram. Pull green/white (gn/ws) wire 2 into protective sleeving provided.

- 1 Green/white (gn/ws) wire X1/4
- 2 Green/white (gn/ws) wire



**Extending green/white (gn/ws) wire**



Insert disconnected wires from fuses F1 and F2 with power timer in free sockets of fuse and relay carrier.

Route green/white (gn/ws) wire together with wiring harness of digital timer into passenger compartment!

- 1 Socket for 1 A fuse F2
- 2 Socket for 20 A fuse F1



**Installing fuse F1 and F2**



## Electrical system

### Wiring harness pass through

- 1 Wiring harness of metering pump and fuel line in corrugated hose
- 2 Protective rubber plug
- 3 Wiring harness of heater unit and fuel line in corrugated hose

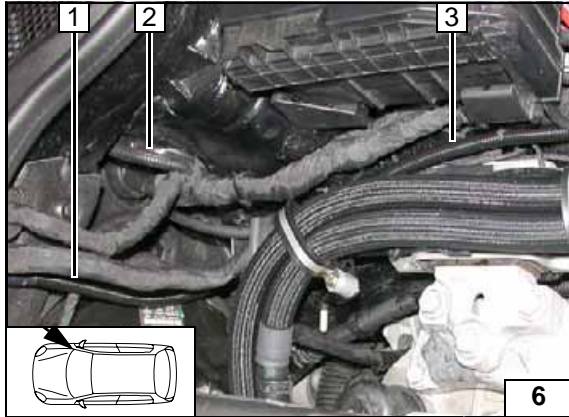

### Digital timer

- 1 Digital timer

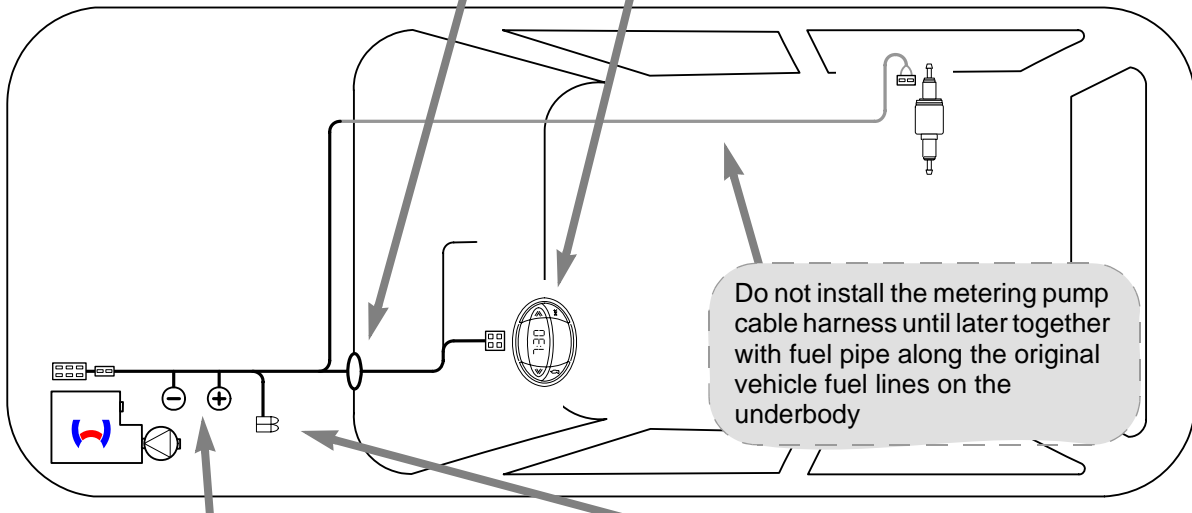
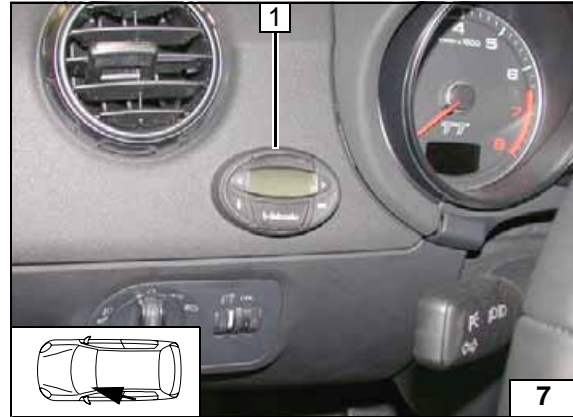

Wiring harness installation diagram

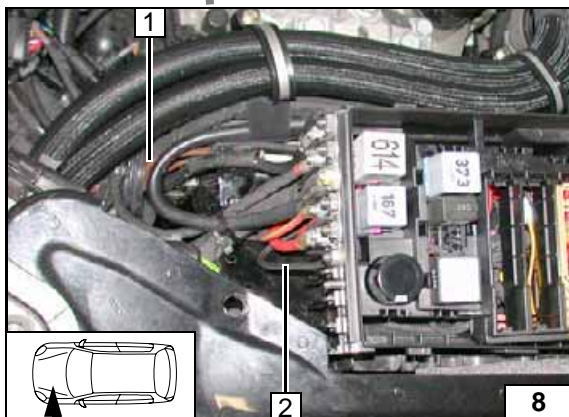

### Positive and ground wire

- 1 Ground wire on original vehicle ground support point
- 2 Positive wire on original vehicle positive support point

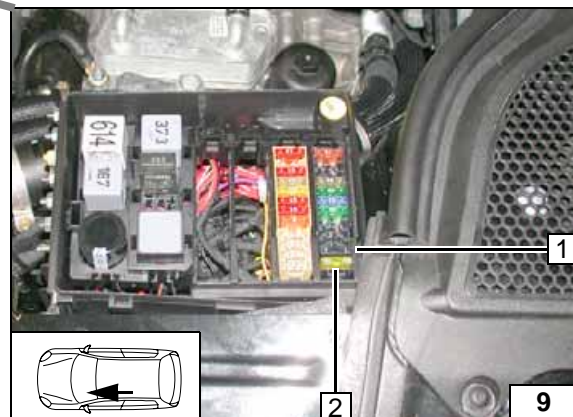

### Completing fuses

Mount fuses in prepared sockets of black (sw) fuse bar.

- 1 1 A fuse F2
- 2 20 A fuse F1



Fan controller

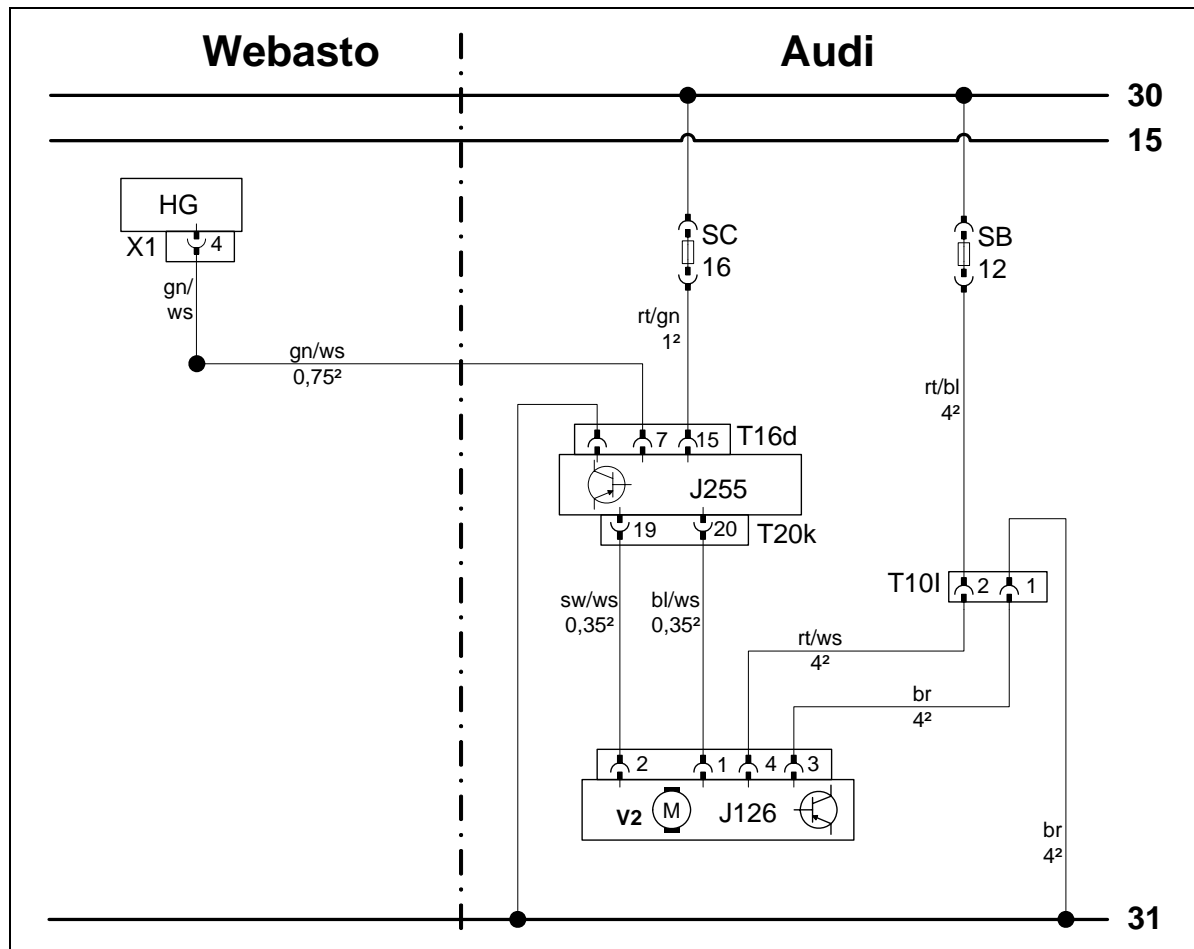

Automatic air-conditioning circuit diagram

| Webasto components |                             | Vehicle components |                                | Colors and symbols      |       |
|--------------------|-----------------------------|--------------------|--------------------------------|-------------------------|-------|
| HG                 | Heater unit TT-C/E          | SC16               | 10 A fuse                      | gn                      | green |
| X1                 | 6-pin heater unit connector | SB12               | Fuse 40A                       | ws                      | white |
|                    |                             | J255               | Air-conditioning control panel | rt                      | red   |
|                    |                             | T16d               | 16-pin connector D J255        | bl                      | blue  |
|                    |                             | T20k               | 20-pin connector J255          | br                      | brown |
|                    |                             | J126               | Fan unit                       | sw                      | black |
|                    |                             | V2                 | Fan motor                      |                         |       |
|                    |                             | T10I               | 10-pin connector               |                         |       |
|                    |                             |                    |                                | Wiring colors may vary. |       |

Legend

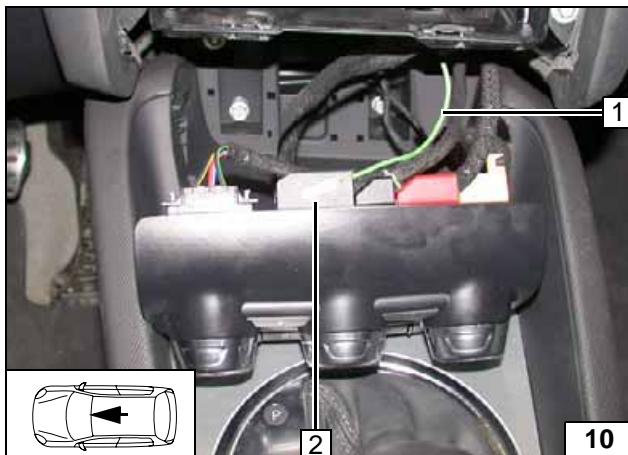

Connection on 16-pin connector D 2 of A/C control panel J255 (use microtimer provided). Produce connections as shown in wiring diagram.

1 Green/white (gn/ws) wire on connector D Pin 7



Connecting A/C control panel



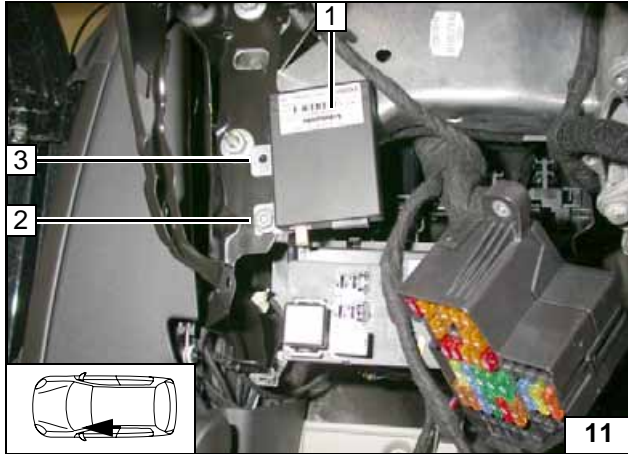

**Remote option (Telestart)**

- 1 Receiver
- 2 Original vehicle flanged nut
- 3 Telestart bracket



**Installing receiver**

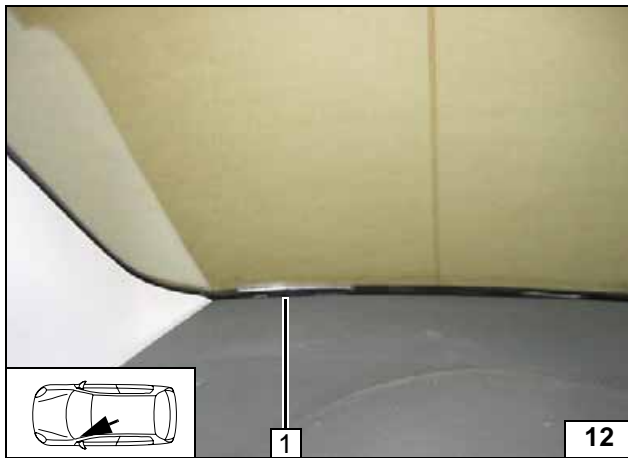

- 1 Antenna

**Installing antenna**

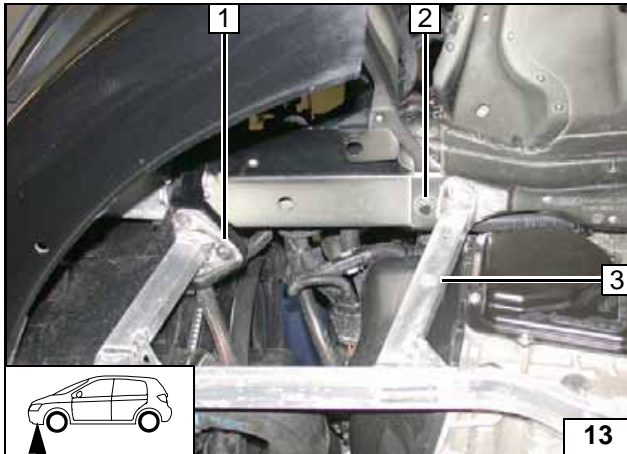
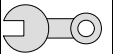

**Preparing installation location**

Remove original vehicle bolts at position 1 and 2 [2x]. Original vehicle bolt 2 will be reused:

3 Rivet nut in original vehicle hole



**Installing rivet nut**

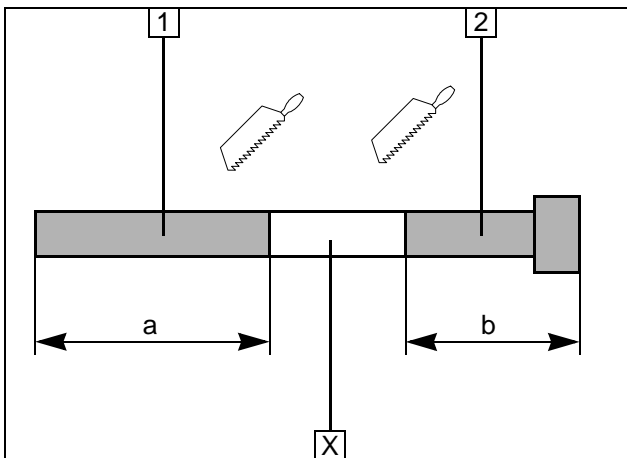

**Preparing heater unit**

- 1 Exhaust pipe  
a = 280 mm
- 2 Exhaust end section  
b = 80 mm

Discard section X

**Preparing exhaust pipe**

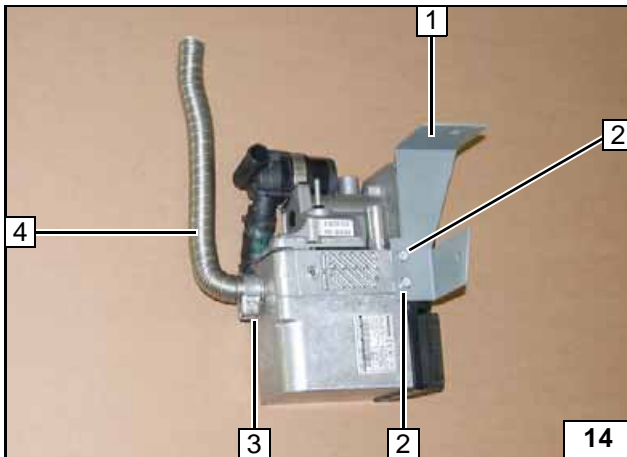

- 1 Bracket 1
- 2 E-jot screw [2x]
- 3 Hose clamp
- 4 Exhaust pipe

**Installing bracket 1 on heater unit**

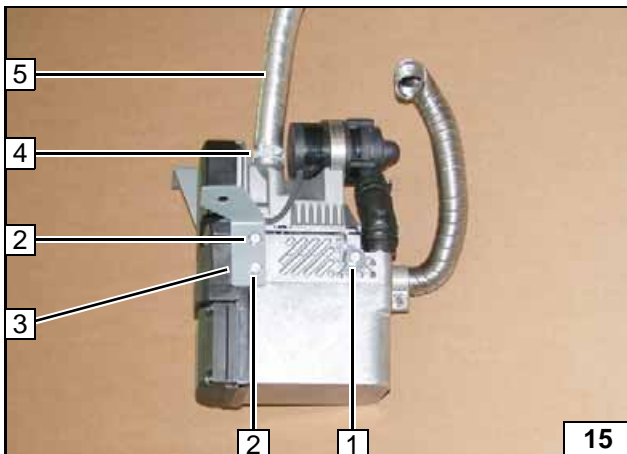

- 1 Angle bracket, E-jot screw
- 2 E-jot screw [2x]
- 3 Bracket 2
- 4 22 mm dia. spring clip
- 5 Combustion-air intake pipe

**Installing bracket 2 on heater unit**

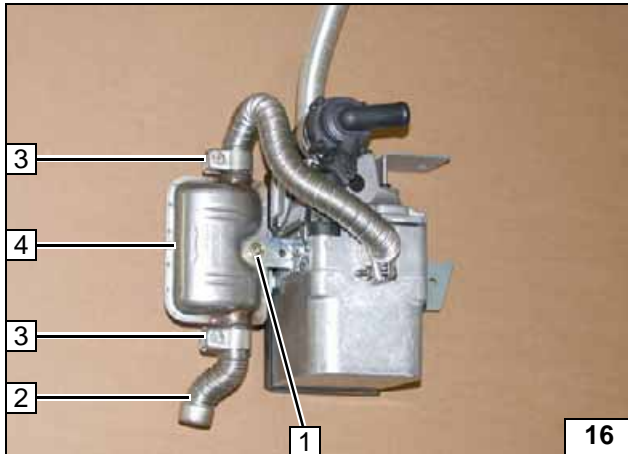
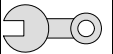

- 1 M6x20 bolt, flanged nut
- 2 Exhaust end section
- 3 Hose clamp [2x]
- 4 Muffler



Installing muffler

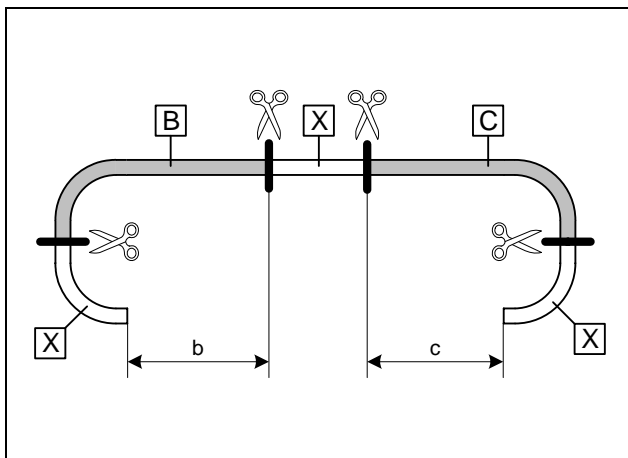

b = 750 mm  
c = 910 mm

Discard section X

Cutting coolant hoses to length

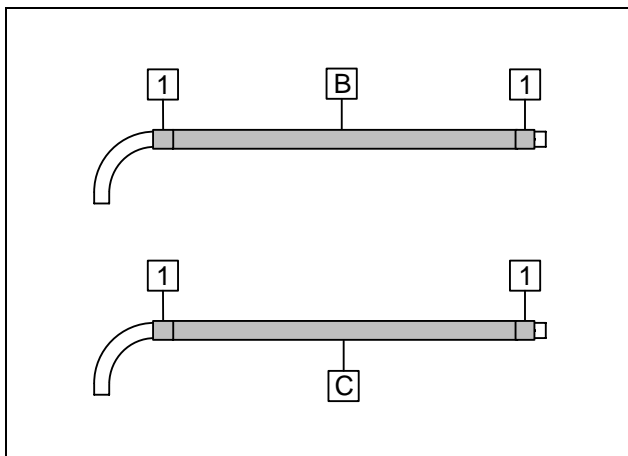

Push braided protection hoses onto hose **B** and **C** and cut to length.  
Cut heat shrink plastic tubing to length.

- 1 25 mm heat shrink plastic tubing [4x]



Preparing coolant hoses

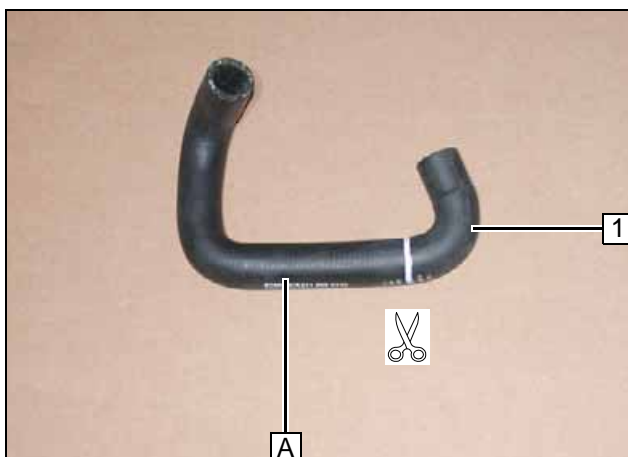

- 1 Discard hose section

Cutting hose A to length

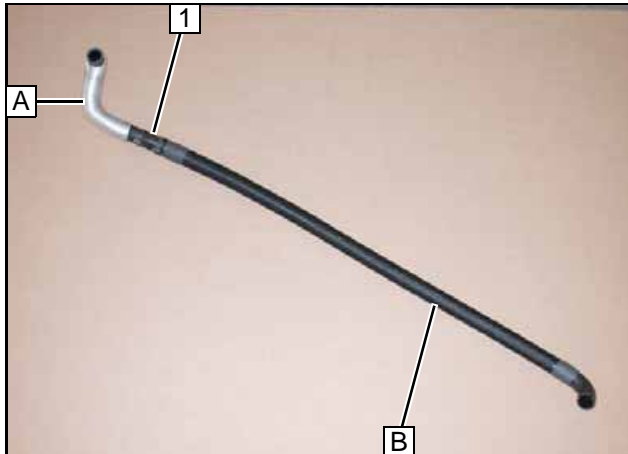
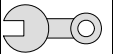

Slide heat protection hose onto hose A.

- 1 18x20 connecting pipe, 25 mm dia. spring clip, 27 mm dia. spring clip



Pre-mounting hose A and B

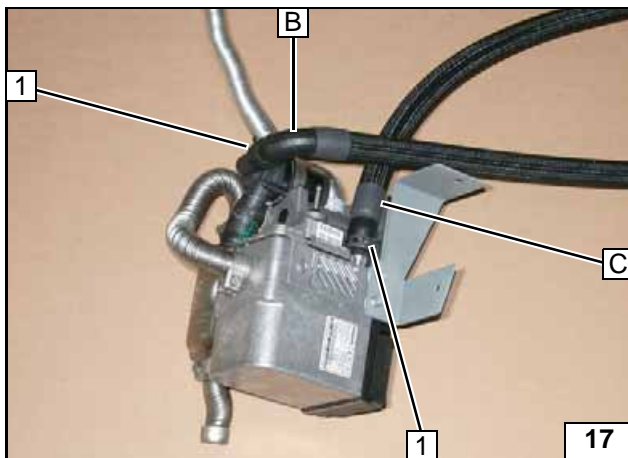

- 1 27 mm dia. spring clip [2x]

Installing coolant hoses

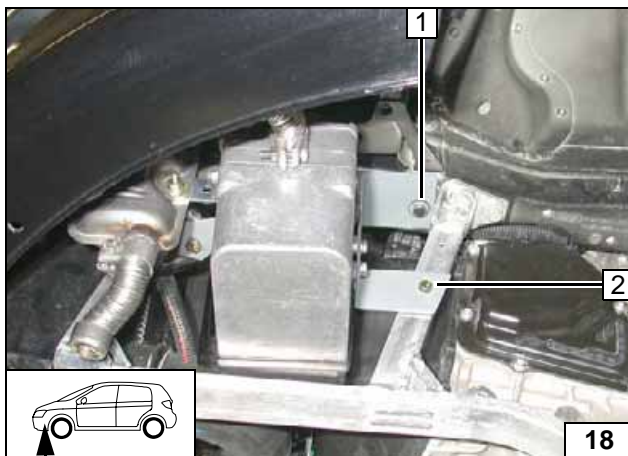

Installing heater unit

- 1 Original vehicle bolt
- 2 M6x20 bolt, spring lockwasher

Installing heater unit

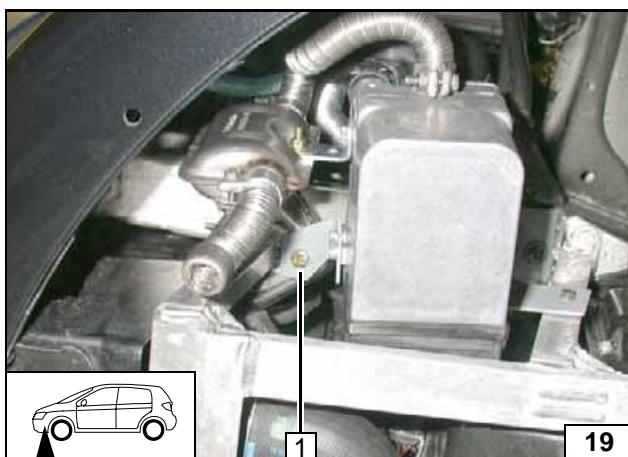

- 1 M8x30 bolt, spring lockwasher, 5 mm shim

Installing heater unit

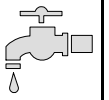



**Water**

**WARNING!**

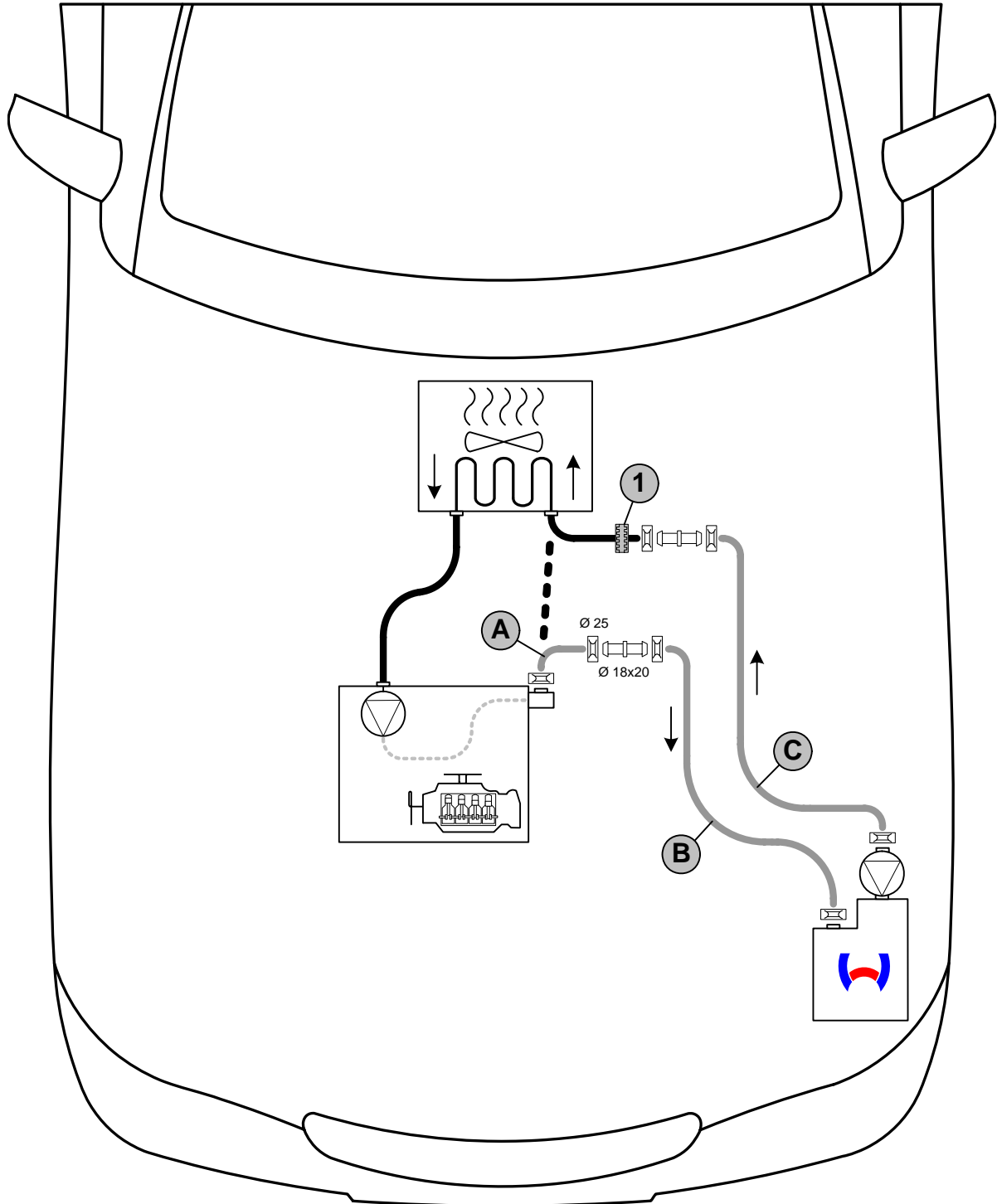
Any coolant running off should be collected using an appropriate container.  
 Install hoses so that they are kink-free. Unless specified otherwise, always fasten using cable ties.  
 Position clamps so that no other hose can be damaged!  
 The connection should be "inline" based on the following diagram:



Coolant routing diagram

All spring clips without a specific designation  = 27 mm dia.  
**1** = Black (sw) rubber isolator .  
 All connecting pipes without a specific designation  = dia. 20x20.



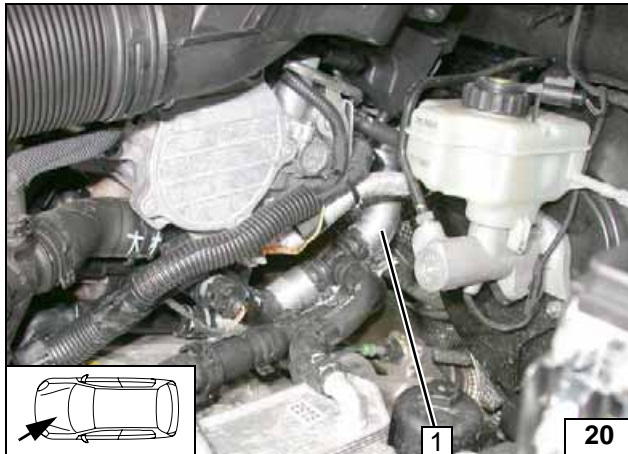
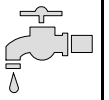

Pull off original vehicle hose 1 from engine outlet to heat exchanger inlet on connection piece of engine outlet. Spring clip will be reused.



**Cutting point**

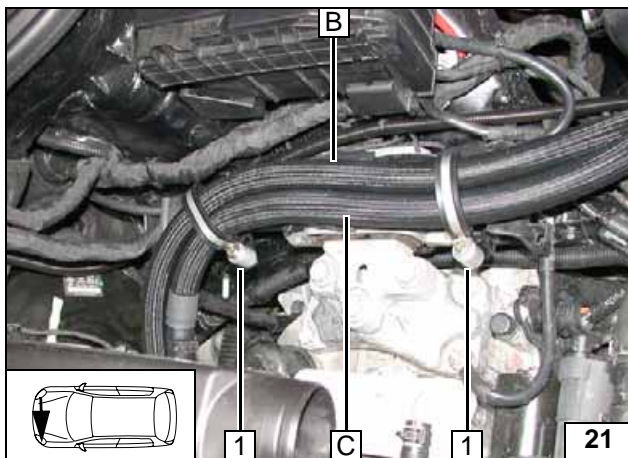

1 M6x35 bolt, 48 mm dia. rubber-coated p-clamp, 20 mm shim, flanged nut [2x each] on existing hole

**Routing in engine compartment**

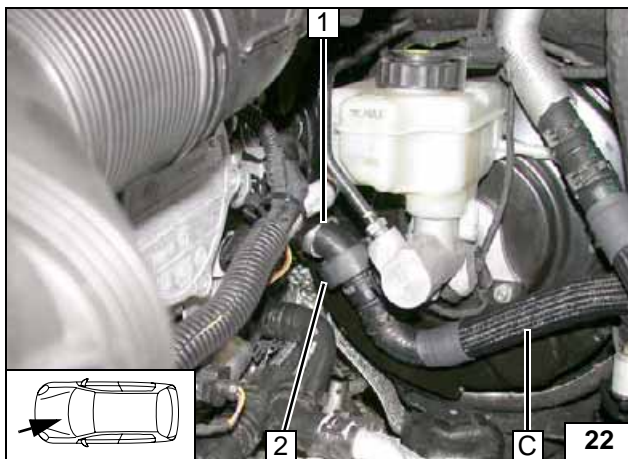

Before installing, slide black (sw) rubber isolator 2 onto hose section on heat exchanger inlet 1.



**Connecting heat exchanger inlet**

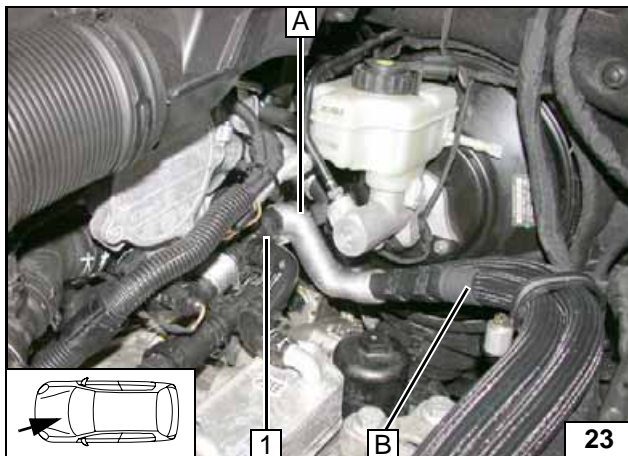

Before connecting, fill the coolant hoses with coolant.

1 Original vehicle spring clip



**Connection on engine outlet**

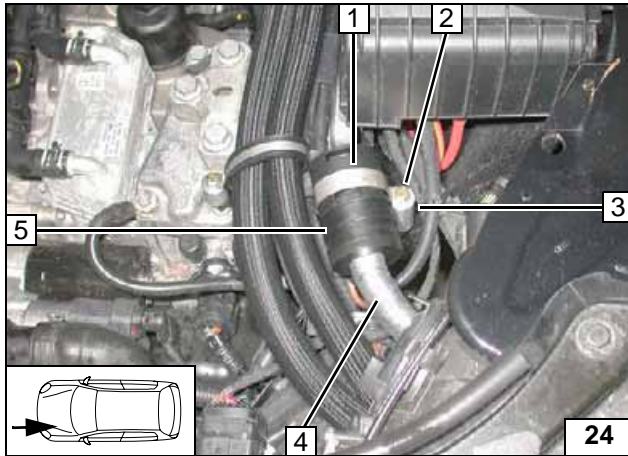
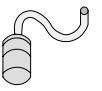

**Combustion air**

Ensure proper installation position of intake muffer **5**, see "Installation Instructions".

- 1** 48 mm dia. p-clamp; rubber coating removed
- 2** M6x55 bolt on existing threaded hole
- 3** 40 mm shim
- 4** Combustion-air intake pipe



**Installing muffer**



**Fuel**

**CAUTION!**

Open the vehicle's fuel tank cap, ventilate the tank and then re-close the tank lock.

Catch any fuel running off with an appropriate container.

Install fuel line and metering-pump wiring harness so that they are protected against stone impact. Unless specified otherwise, always fasten using cable ties.

Mount the fuel line and wiring harness with rub protection on sharp edges.

**WARNING!**

The fuel line and wiring harness are routed to the metering pump in as shown in the wiring harness routing diagram.

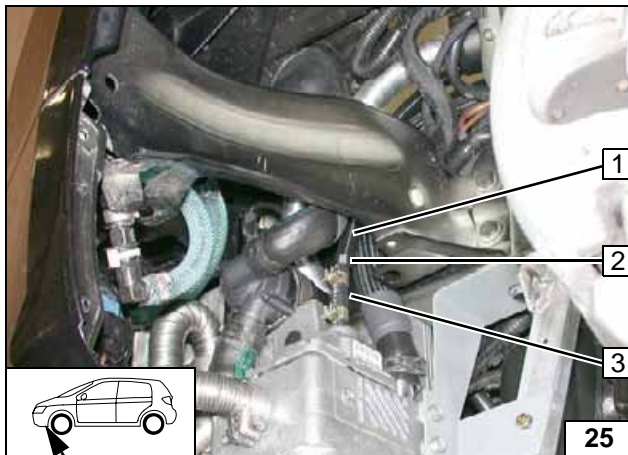

- 1 Corrugated hose
- 2 Fuel line
- 3 Hose section, 10 mm dia. clamp [2x]

**Con-  
nection to  
heater unit**

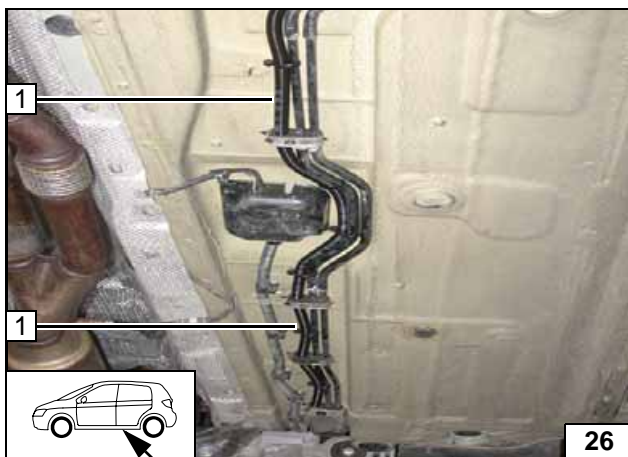

- 1 Fuel line and wiring harness for metering pump in corrugated hose

**Installing  
lines**

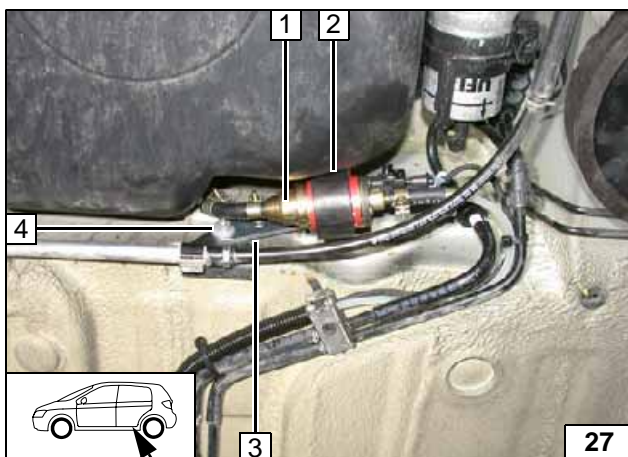

Ensure proper installation position of metering pump 1, see "Installation Instructions".  
Installation location on right in front of vehicle fuel tank!

- 2 Bracket of metering pump, M6x20 bolt, flanged nut on perforated bracket
- 3 Perforated bracket
- 4 Original vehicle stud bolt, flanged nut



**Installation  
location of  
metering  
pump**



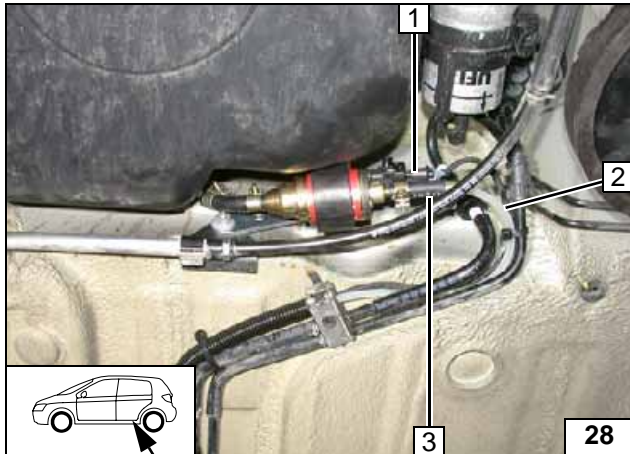

Connect fuel line 2 from heater unit to pressure side of metering pump [side with connector].

- 1 Wiring harness of metering pump, connector mounted
- 3 Hose section, 10 mm dia. clamp [2x]

Connecting metering pump

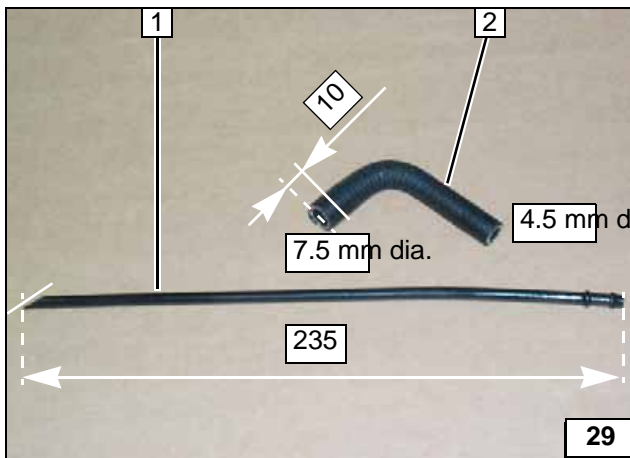

- 1 Standpipe
- 2 90° molded hose

Cutting standpipe and molded hose to length

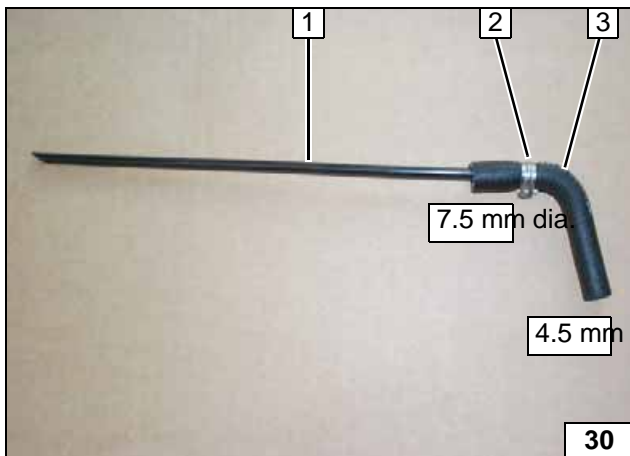

Caillau clamp in center between beads on end of standpipe.

- 1 Standpipe
- 2 10 mm dia. Caillau clamp
- 3 90° molded hose



Preparing fuel standpipe

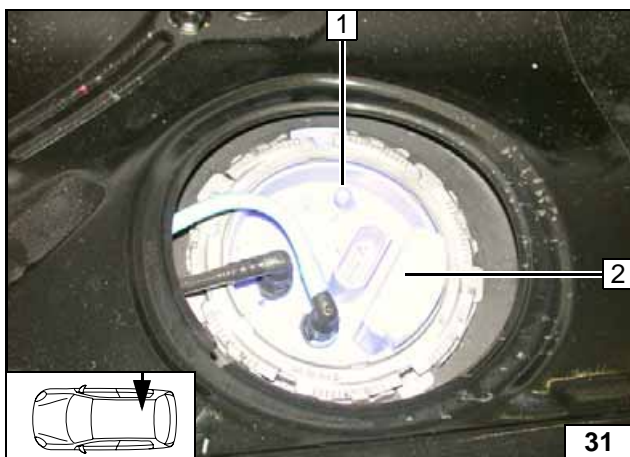

Expose fuel-tank sending unit 2.

- 1 Cut off blind plug at upper marking



Removing fuel

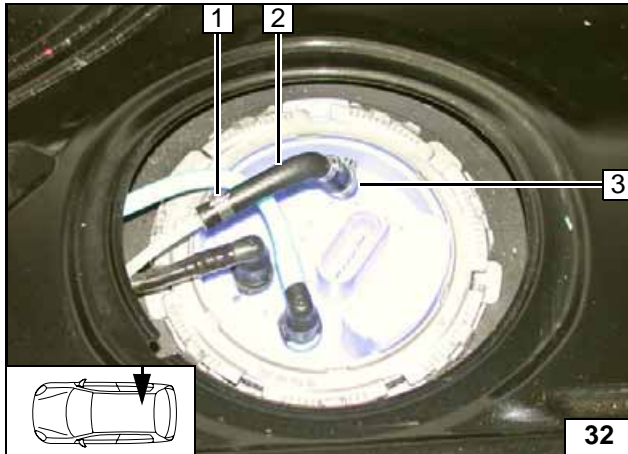

- 1 10 mm dia. Caillau clamp
- 2 90° molded hose
- 3 13.5 mm dia. Caillau clamp

**Con-  
necting  
fuel line**

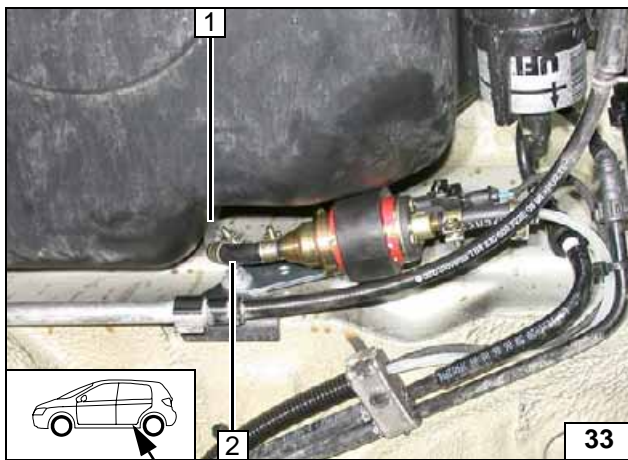

Fuel line 1 from fuel standpipe on intake side of metering pump [side without connector]. Check the position of the components; adjust if necessary. Check that they have free clearance.

- 2 Hose section, 10 mm dia. clamp [2x]



**Con-  
necting to  
metering  
pump**

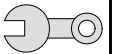

**Final Work**

**WARNING!**

Reassemble the disassembled components in reverse order.  
 Check all hoses, clamps and all electrical connections for firm seating.  
 Secure all loose cables using cable ties.  
 Only use manufacturer-approved coolant.  
 Spray the heater unit components with anti-corrosion wax (Tectyl 100K, Order No. 111329).

- Connect the battery
- Fill and bleed the coolant circuit according to the vehicle manufacturer's specifications.
- Set the digital timer.
- Make settings according to the "Operating Instructions for End Customer"
- Check the proper operation of the additional heater, see the operating instructions/installation instructions.
- Attach the "Switch off additional heater before refueling" sticker to the left-hand B-pillar.

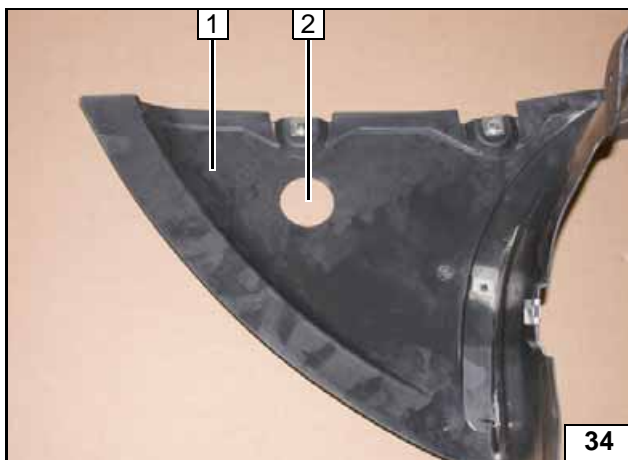

- 1 Underride protection
- 2 42 mm dia. hole

**Cutting out  
underride  
protection**

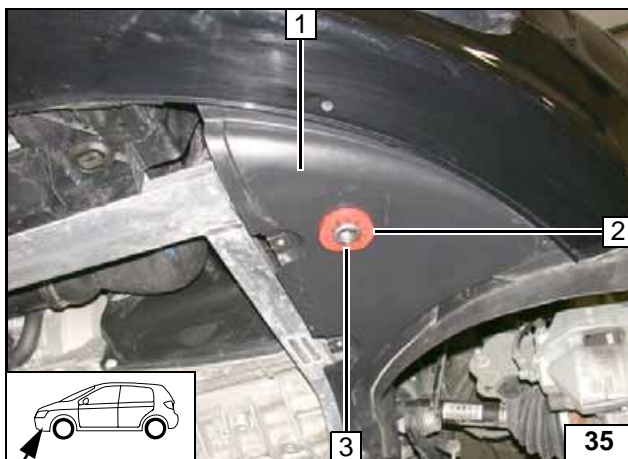

Align exhaust end section **3** flush on red (rt) rubber isolator **2**.

- 1 Underride protection



**Mounting  
rubber  
isolator**



Webasto AG  
 Postfach 80 - 82132 Stockdorf  
 Hotline 01805 / 932278 - Hotfax 0395 / 5592-353  
<http://www.webasto.de>

## Operating Instructions for End Customer



Please remove page and add to the vehicle operating instructions.



### Note:

We recommend matching the heating time to the driving time.

Heating time = driving time

### Example:

For a driving time of approx. 20 min. (in one direction), we recommend not exceeding a switch-on time of 20 min.

If the summer/winter switch option has been installed, this must be switched in accordance with the time of year. The heater unit will then only switch on the vehicle fan to ventilate the vehicle interior in the position Winter  heat and in the position Summer .

Before parking the vehicle, make the following settings:



- 1 Set temperature to "max."

Automatic  
air-con-  
ditioning